



Truck and Trailer S-Camshafts and Camshaft Overhaul Kits

Heavy Duty Components

UHB800-CAM

April 2002





CAUTION! The items in this catalog are listed for use only in the applications and interchanges that appear in the catalog. Other use could result in property damage or serious personal injury. Always refer to the vehicle, trailer, or component manufacturer's service manual when performing vehicle maintenance.

NOTE: The data listed herein is correct to the best of our knowledge and belief, having been compiled from reliable and official sources of information. **However, we cannot assume any responsibility for possible errors.**

If any errors are found, or you have suggestions on ways to improve future catalogs, we want to hear from you. Please call us at the phone number shown on the back cover. Thank you for your assistance.



Application Identification Information 7

Quick Identification Guide 8

Steer Axle Brake S-Camshafts

Bendix

 15" x 4" "Brazilian" Brake, 1 1/2" Diameter At Spider, 1 1/2" - 10 Spline 28

Eaton

 15" Single Anchor Pin (SAP) Brake, 1 1/4" Diameter At Spider, 1 1/4" - 10 Spline 29

 15" x 4" Extended Service Brake (ES™), 1 1/4" Diameter At Spider,
 1 1/4" - 10 Spline 31

Rockwell

 14 1/2" "W" Brake, 1 1/2" Diameter At Spider, 1 1/2" - 10 Spline 33

 15" x 4" "Q" Brake, 1 1/2" Offset Backing Plate, 1 1/4" Diameter At Spider,
 1 1/4" - 24 Spline 34

 15" x 4" "Q" Brake, 2" Offset Backing Plate, 1 1/4" Diameter At Spider,
 1 1/4" - 24 Spline 35

 15" "T" Series Brake, New Style S-head Cam, 1 1/4" Diameter At Spider, 1 1/4" - 10 Spline 36

 15" "T" Series Brake, Standard T-Head Cam, 1 1/2" Diameter At Spider, 1 1/2" - 10 Spline 37

 15" "T" Series Brake, Standard T-Head, 1 1/4" Diameter At Spider, 1 1/4" - 10 Spline 39

 15" x 4" "Q Plus" Brake, 1 1/2" Diameter At Spider, 1 1/2" - 28 Spline 41

Spicer

 15" x 4" Brake, 1 1/4" Diameter At Spider, 1 1/4" - 10 Spline 42

Wagner

 15" Brake, 1 1/4" Diameter At Spider, 1 1/4" - 10 Spline 43

Drive Axle Brake S-Camshafts

Bendix

 16 1/2" "Brazilian" Brake, 1 1/2" Diameter At Spider, 1 1/2" - 10 Spline 44

Eaton

 16 1/2" Brake, 1 1/2" Diameter At Spider, 1 1/2" - 10 Spline 45

 16 1/2" Extended Service (ES™) Brake, 1 1/2" Diameter At Spider,
 1 1/2" - 10 Spline 48

 16 1/2" and 18" Brake, 1 1/2" Diameter At Spider, 1 1/2" - 10 Spline 49

Rockwell

 14 1/2" "W" Brake, 1 1/2" Diameter At Spider, 1 1/2" - 10 Spline 50

 16 1/2" Brake, 1 1/2" Diameter At Spider, 1 1/2" - 10 Spline 51

 16 1/2" Brake, 1 1/2" Diameter At Spider, 1 1/2" - 28 Spline 55

 16 1/2" "Q Plus" Brake, 1 1/2" Diameter At Spider, 1 1/2" - 28 Spline 59

Spicer

 16 1/2" x 5", 6" and 7" "XL" and "XLII" Brakes, 1 1/2" Diameter At Spider,
 1 1/2" - 28 Spline, 1 1/8" head 63

 16 1/2" x 5", 6" and 7" "XL" and "XLII" Brakes, 1 1/2" Diameter At Spider,
 1 1/2" - 28 Spline, 1 3/8" head 64

Trailer Axle Brake S-Camshafts

Dexter

12 1/4" Brake, 1 1/2" Diameter At Spider, 1 1/2" - 28 Spline 65

Eaton

16 1/2" Single Anchor Pin (SAP) Brake, 501 Series Axle, 1 5/8" Diameter At Spider,
1 1/2" - 10 Spline 67

16 1/2" Single Anchor Pin (SAP) Brake, 501 Series Axle, 1 5/8" Diameter At Spider,
1 1/2" - 28 Spline 68

16 1/2" Extended Service (ES™) Brake, 1 5/8" Diameter At Spider,
1 1/2" - 10 Spline 69

16 1/2" Extended Service(ES™) Brake, 1 5/8" Diameter At Spider,
1 1/2" - 28 Spline 70

Eaton Shuler

12 1/4" Single Anchor Pin (SAP) Brake, 1 1/2" Diameter At Spider,
1 1/2" - 10 Spline 71

16 1/2" Brake, 1 1/2" Diameter At Spider, 1 1/2" - 10 Spline 72

Fruehauf

12 1/4" Brake, "Pro-Par" Type Axle, 1 5/8" Diameter At Spider, 1 19/32" - 37 Spline 73

16 1/2" Brake, "Pro-Par" Type Axle, 1 5/8" Diameter At Spider, 1 1/2" - 28 Spline 74

16 1/2" Brake, "Pro-Par" Type Axle, 1 5/8" Diameter At Spider, 1 19/32" - 37 Spline 75

Intraax

16 1/2" Brake, 1 1/2" Diameter At Spider, 1 1/2" - 28 Spline 76

Multi-Application

16 1/2" Brake, 1 1/2" Diameter At Spider, 1 1/2" - 10 Spline, Single Groove 77

16 1/2" Brake, 1 1/2" Diameter At Spider, 1 1/2" - 10 Spline, Double Groove 81

Rockwell

12 1/4" Brake, Small S-Head Type Cam, 1 5/8" Diameter At Spider, 1 1/2" - 10 Spline 82

12 1/4" Brake, Small S-Head Type Cam, 1 5/8" Diameter At Spider, 1 1/2" - 28 Spline 83

16 1/2" Brake, 4000-6000 Series Axle with Cast Brake Spider, 1 5/8" Diameter At Spider,
1 1/2" - 28 Spline 84

16 1/2" Brake, 4000-6000 Series Axle with Fabricated Spider,
1 5/8" Diameter At Spider, 1 1/2" - 28 Spline 85

16 1/2" "Q Plus" Brake, 4000-6000 Series Axle with Cast Spider,
1 5/8" Diameter At Spider, 1 1/2" - 28 Spline 86

16 1/2" Brake, 4000-6000 Series Axle with Cast Spider,
1 5/8" Diameter At Spider, 1 1/2" - 10 Spline 87

16 1/2" "Q Plus" Brake, with Forged or Fabricated Spider,
1 5/8" Diameter At Spider, 1 1/2" - 28 Spline 88



Trailer Axle Brake S-Camshafts (Continued)

Spicer

SERVICE INFORMATION 89

12 1/4" Brake, 1 5/8" Diameter At Spider, 1 1/2" - 10 Spline
 (Used On Axles Manufactured After February, 1996) 90

12 1/4" Brake, 1 5/8" Diameter At Spider, 1 1/2" - 28 Spline
 (Used On Axles Manufactured After February, 1996) 92

12 1/4" Brake, 1 1/2" Diameter At Spider, 1 1/2" - 10 Spline
 (Used On Axles Manufactured After July, 1994) 94

12 1/4" Brake, 1 1/2" Diameter At Spider, 1 1/2" - 28 Spline
 (Used On Axles Manufactured After July, 1994) 97

12 1/4" Brake, 1 1/2" Diameter At Spider, 1 1/2" - 10 Spline
 (Used On Axles Manufactured Before August, 1994) 99

12 1/4" Brake, 1 1/2" Diameter At Spider, 1 1/2" - 28 Spline
 (Used On Axles Manufactured Before August, 1994) 102

16 1/2" Brake, Standard S-Head Cam, 1 1/2" Diameter At Spider, 1 1/2" - 28 Spline 103

16 1/2" Brake, Trunnion Axles, 1 1/16" Tip, 1 1/2" Diameter At Spider,
 1 1/2" - 10 Spline 104

16 1/2" Brake, Trunnion Axles, 1 1/2" Tip, 1 1/2" Diameter At Spider,
 1 1/2" - 10 Spline 105

16 1/2" "Xtralife" (XL) Brake, 1 1/2" Diameter At Spider, 1 1/2" - 28 Spline 106

16 1/2" "Xtralife" (XL) Brake, 1 5/8" Diameter At Spider, 1 1/2" - 28 Spline 109
 (Used On Axles Manufactured After September, 1995)

16 1/2" "Xtralife" (XL) Brake, 1 1/2" Diameter At Spider, 1 1/2" - 10 Spline 111

16 1/2" "Xtralife" (XL) Brake,, 1 5/8" Diameter At Spider, 1 1/2" - 10 Spline 114
 (Used On Axles Manufactured After September, 1995)

20" Brake, 1 3/4" Diameter At Spider, 1 3/4" - 10 Spline 116

S-Camshaft Overhaul Kits 117

Camshaft Enclosures 142

 Support Bracket Mounting Plates 144

Cross Reference 145

Glossary of Terms 209

Part Number Index 214

Catalog Comment Form 219

APPLICATION IDENTIFICATION INFORMATION



CAMS - S-HEAD
Identification
View From Head End
R.H. - CAMS

Right Hand

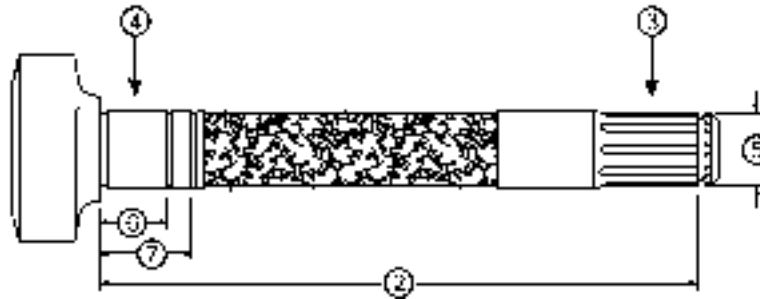

CAMS - S-HEAD
Identification
View From Head End
L.H. - CAMS

Left Hand

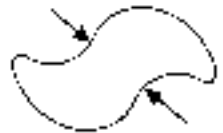

In order to select the correct S-cam part number, you must know the following information.

- ① Application: Steer, Drive or Trailer
Make of axle manufacturer
Suspension model when noted
- ② Cam length: Measurement from under cam head to beginning of lock ring groove at camshaft tip. See dimension A on application specific pages.
- ③ Spline diameter and number of splines. (10, 24, 28 or 37)
- ④ Diameter of camshaft at spider.
- ⑤ Diameter of camshaft at camshaft tip.
- ⑥ Length of spider bushing bearing journal from under cam head to beginning of lock ring groove. See dimension B on application specific pages.
- ⑦ Length of spider bushing bearing journal from under cam head to beginning of second lock ring groove if applicable. See dimension C on application specific pages.
- ⑧ Cam head style (see below).

HEAD STYLES	<p>Style A Standard "S"</p>	<p>Style B Extended Service 16 1/2" Brake</p>	<p>Style C Spicer/Eaton 12 1/4" Brake (Galore 08-94)</p>	<p>Style D Fruschhof 12 1/4" Brake</p>	<p>Style E Spicer High Rise 12 1/4" Brake (After 07-94)</p>	<p>Style F Rockwell "T" 15" Brake</p>
	<p>Style G Rockwell "New S" 15" Brake</p>	<p>Style H Extended Service (DAP) 15" Brake</p>	<p>Style I Spicer/Eaton (SAP) 15" Brake</p>	<p>Style J Spicer Eaton Extended Service (SAP) 15" Brake</p>	<p>Style K Spicer 20" Brake</p>	

How to use this Quick Identification Guide

1. Measure camshaft length. Measure from under the cam head to the beginning of the lock ring groove (as illustrated on page 7).
2. Locate camshaft length in the Camshaft Quick Identification Guide. Camshafts are listed in order of length, from shortest to longest.
3. After finding camshafts in the Cam Length column, determine camshaft head style, using the Head Styles chart and head width dimensions.
4. Narrow your final selection by Diameter at Spline End and Number of Splines, Diameter at Spider and any other information listed.

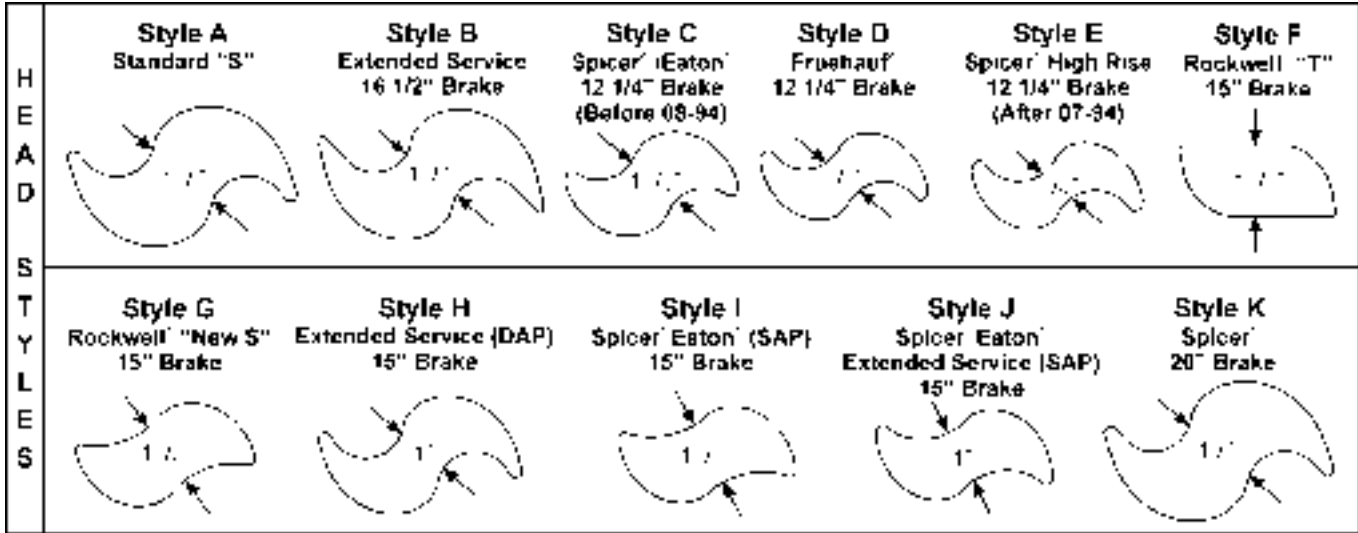

These graphics are for identification purposes only. Dimensions in actual camshafts may vary slightly.

Cam Length	Head Style	Diameter at Spline End & No. of Splines	Diameter at Spider	Spicer Part Number	Side	Axle Type*	Brake Manufacturer	Brake Size	Notes
4 7/8"	A	1 1/2" - 10	1 1/2"	17-600 17-601	RH LH	T	Spicer	16 1/2"	Spicer Custom Trunnion Suspension; 1 1/16" tip
5 3/32"	A	1 1/2" - 10	1 1/2"	18-792 18-793	RH LH	D	Rockwell	16 1/2"	
5 13/64"	A	1 1/2" - 10	1 1/2"	18-992 18-993	RH LH	S	Rockwell	14 1/2"	"W" Brake
5 3/8"	A	1 1/2" - 10	1 1/2"	18-990 18-991	RH LH	S	Rockwell	14 1/2"	"W" Brake
5 1/2"	A	1 1/2" - 10	1 1/2"	17-602 17-603	RH LH	T	Spicer	16 1/2"	Spicer Custom Trunnion Suspension; 1 1/16" tip
5 23/32"	I	1 1/4" - 10	1 1/4"	18-910 18-911	RH LH	S	Wagner	15"	
5 25/32"	F	1 1/2" - 10	1 1/2"	18-840 18-841	RH LH	S	Rockwell	15"	"T" Series Brake
6 1/8"	A	1 1/2" - 10	1 1/2"	17-604 17-605	RH LH	T	Spicer	16 1/2"	Spicer Custom Trunnion Suspension; 1 1/16" tip
6 1/4"	A	1 1/2" - 10	1 1/2"	18-986 18-987	RH LH	D	Rockwell	14 1/2"	"W" Brake
6 3/8"	A	1 1/2" - 10	1 1/2"	18-800 18-801	RH LH	D	Rockwell	16 1/2"	
6 3/4"	A	1 1/2" - 10	1 1/2"	17-606 17-607	RH LH	T	Spicer	16 1/2"	Spicer Custom Trunnion Suspension; 1 1/16" tip

*Axle Type: S = Steer, D = Drive, T = Trailer

Cam Length	Head Style	Diameter at Spline End & No. of Splines	Diameter at Spider	Spicer Part Number	Side	Axle Type*	Brake Manufacturer	Brake Size	Notes
6 15/16"	B	1 1/2" - 28	1 1/2"	18-670 18-671	RH LH	D	Spicer	16 1/2"	"XL" and "XLII" Brakes; 5", 6" and 7" Brakes
7 1/8"	G	1 1/4" - 24	1 1/4"	18-902 18-903	RH LH	S	Rockwell	15"	"Q" Brake; 2" Offset Backing Plate
7 3/8"	A	1 1/2" - 10	1 1/2"	17-608 17-609	RH LH	T	Spicer	16 1/2"	Spicer Custom Trunnion Suspension; 1 1/2" tip
7 9/16"	F	1 1/2" - 10	1 1/2"	18-842 18-843	RH LH	S	Rockwell	15"	"T" Series Brake
7 5/8"	A	1 1/2" - 10	1 1/2"	17-610 17-611	RH LH	T	Spicer	16 1/2"	Spicer Custom Trunnion Suspension; 1 1/2" tip
7 5/8"	I	1 1/4" - 10	1 1/4"	18-760 18-761	RH LH	S	Eaton	15"	Single Anchor Pin (SAP)
7 5/8"	J	1 1/4" - 10	1 1/4"	18-960 18-961	RH LH	S	Eaton	15"	Extended Service Brake (ESTM); Single Anchor Pin (SAP)
7 21/32"	F	1 1/4" - 10	1 1/4"	18-1129 18-1130	LH RH	S	Rockwell	15"	"T" Series Brake
7 21/32"	G	1 1/4" - 10	1 1/4"	18-954 18-955	RH LH	S	Rockwell	15"	"T" Series Brake; New Style S-Head
7 23/32"	B	1 1/2" - 28	1 1/2"	18-500 18-501	RH LH	D	Rockwell	16 1/2"	"Q Plus" Brake
7 23/32"	A	1 1/2" - 28	1 1/2"	18-796 18-797	RH LH	D	Rockwell	16 1/2"	
7 23/32"	G	1 1/4" - 24	1 1/4"	18-904 18-905	RH LH	S	Rockwell	15"	"Q" Brake; 2" Offset Backing Plate
7 3/4"	A	1 1/2" - 28	1 1/2"	18-640 18-641	RH LH	D	Spicer	16 1/2"	5", 6", and 7" Brakes
7 27/32"	A	1 1/2" - 10	1 1/2"	18-988 18-989	RH LH	D	Rockwell	14 1/2"	"W" Brake
7 7/8"	A	1 1/2" - 10	1 1/2"	18-802 18-803	RH LH	D	Rockwell	16 1/2"	
7 15/16"	A	1 1/4" - 10	1 1/4"	18-620 18-621	RH LH	S	Spicer	15"	
7 15/16"	I	1 1/4" - 10	1 1/4"	18-762 18-763	RH LH	S	Eaton	15"	Single Anchor Pin (SAP)
7 15/16"	F	1 1/4" - 10	1 1/4"	18-856 18-857	RH LH	S	Rockwell	15"	"T" Series Brake
7 15/16"	G	1 1/4" - 24	1 1/4"	18-890 18-891	RH LH	S	Rockwell	15"	"Q" Brake; 1 1/2" Offset Backing Plate
7 15/16"	G	1 1/4" - 10	1 1/4"	18-950 18-951	RH LH	S	Rockwell	15"	"T" Series Brake; New Style S-Head
7 15/16"	J	1 1/4" - 10	1 1/4"	18-962 18-963	RH LH	S	Eaton	15"	Extended Service Brake (ESTM); Single Anchor Pin (SAP)
8 1/32"	F	1 1/2" - 10	1 1/2"	18-844 18-845	RH LH	S	Rockwell	15"	"T" Series Brake
8 1/16"	B	1 1/2" - 28	1 1/2"	18-502 18-503	RH LH	D	Rockwell	16 1/2"	"Q Plus" Brake
8 1/16"	A	1 1/2" - 10	1 1/2"	18-854 18-855	RH LH	D	Rockwell	16 1/2"	
8 1/8"	A	1 1/4" - 10	1 1/4"	18-622 18-623	RH LH	S	Spicer	15"	

*Axle Type: S = Steer, D = Drive, T = Trailer

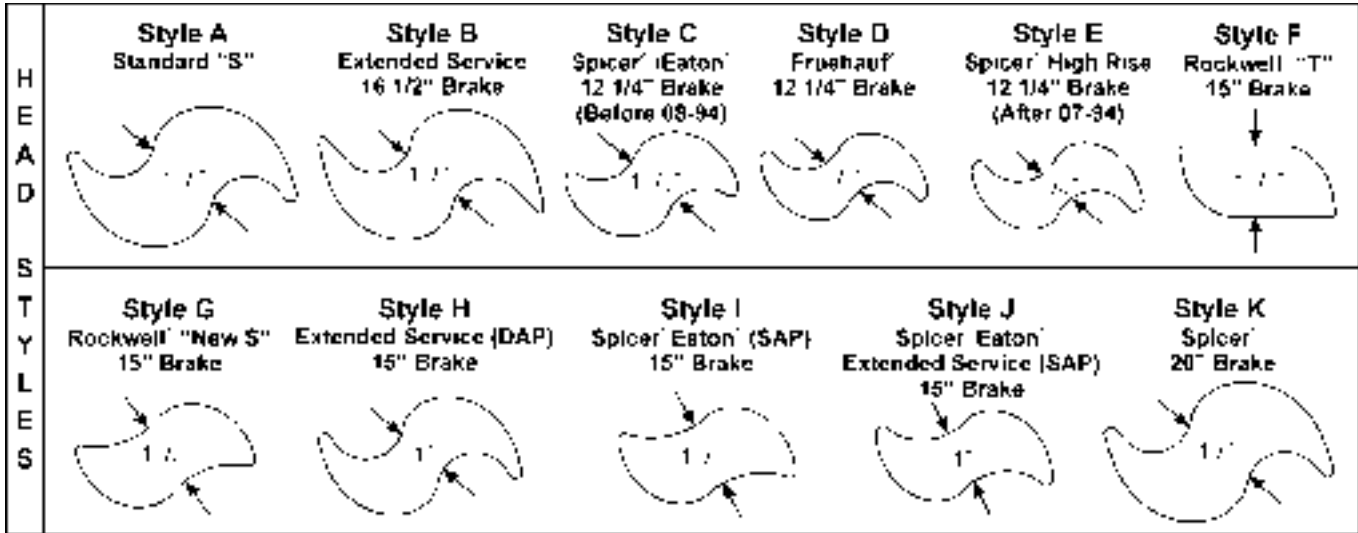

These graphics are for identification purposes only. Dimensions in actual camshafts may vary slightly.

Cam Length	Head Style	Diameter at Spine End & No. of Splines	Diameter at Spider	Spicer Part Number	Side	Axle Type*	Brake Manufacturer	Brake Size	Notes
8 1/8"	A	1 1/2" - 28	1 1/2"	18-642 18-643	RH LH	D	Spicer	16 1/2"	5", 6" and 7" Brakes
8 1/8"	A	1 1/2" - 28	1 1/2"	18-860 18-861	RH LH	D	Rockwell	16 1/2"	
8 11/64"	I	1 1/4" - 10	1 1/4"	18-764 18-765	RH LH	S	Eaton	15"	Single Anchor Pin (SAP)
8 3/16"	A	1 1/2" - 10	1 1/2"	18-704 18-705	RH LH	S	Bendix	15"	Brazilian Brake
8 3/16"	J	1 1/4" - 10	1 1/4"	18-964 18-965	RH LH	S	Eaton	15"	Extended Service Brake (ES™); Single Anchor Pin (SAP)
8 7/32"	F	1 1/2" - 10	1 1/2"	18-846 18-847	RH LH	S	Rockwell	15"	"T" Series Brake
8 3/8"	J	1 1/4" - 10	1 1/4"	18-966 18-967	RH LH	S	Eaton	15"	Extended Service Brake (ES™); Single Anchor Pin (SAP)
8 15/32"	G	1 1/4" - 24	1 1/4"	18-892 18-893	RH LH	S	Rockwell	15"	"Q" Brake; 1 1/2" Offset Backing Plate
8 1/2"	A	1 1/2" - 28	1 1/2"	18-644 18-645	RH LH	D	Spicer	16 1/2"	5", 6" and 7" Brakes
8 1/2"	F	1 1/2" - 10	1 1/2"	18-848 18-849	RH LH	S	Rockwell	15"	"T" Series Brake
8 1/2"	F	1 1/4" - 10	1 1/4"	18-858 18-859	RH LH	S	Rockwell	15"	"T" Series Brake
8 1/2"	G	1 1/4" - 10	1 1/4"	18-952 18-953	RH LH	S	Rockwell	15"	"T" Series Brake; New Style S-Head
8 17/32"	A	1 1/2" - 28	1 1/2"	18-824 18-825	RH LH	D	Rockwell	16 1/2"	
8 17/32"	G	1 1/4" - 24	1 1/4"	18-894 18-895	RH LH	S	Rockwell	15"	"Q" Brake; 1 1/2" Offset Backing Plate
8 9/16"	B	1 1/2" - 28	1 1/2"	18-504 18-505	RH LH	D	Rockwell	16 1/2"	"Q Plus" Brake
8 9/16"	A	1 1/2" - 10	1 1/2"	18-726 18-727	RH LH	D	Eaton	16 1/2"	

*Axle Type: S = Steer, D = Drive, T = Trailer

Cam Length	Head Style	Diameter at Spline End & No. of Splines	Diameter at Spider	Spicer Part Number	Side	Axle Type*	Brake Manufacturer	Brake Size	Notes
8 ⁹ / ₁₆ "	I	1 ¹ / ₄ " - 10	1 ¹ / ₄ "	18-766 18-767	RH LH	S	Eaton	15"	Single Anchor Pin (SAP)
8 ⁹ / ₁₆ "	A	1 ¹ / ₂ " - 10	1 ¹ / ₂ "	18-804 18-805	RH LH	D	Rockwell	16 ¹ / ₂ "	
8 ⁹ / ₁₆ "	J	1 ¹ / ₄ " - 10	1 ¹ / ₄ "	18-968 18-969	RH LH	S	Eaton	15"	Extended Service Brake (EST™); Single Anchor Pin (SAP)
8 ⁵ / ₈ "	A	1 ¹ / ₄ " - 10	1 ¹ / ₄ "	18-624 18-625	RH LH	S	Spicer	15"	
8 ⁵ / ₈ "	B	1 ¹ / ₂ " - 10	1 ¹ / ₂ "	18-940 18-941	RH LH	D	Eaton	16 ¹ / ₂ "	Extended Service Brake (EST™)
8 ²¹ / ₃₂ "	F	1 ¹ / ₂ " - 10	1 ¹ / ₂ "	18-882 18-883	RH LH	S	Rockwell	15"	"T" Series Brake
8 ³ / ₄ "	A	1 ¹ / ₄ " - 10	1 ¹ / ₄ "	18-626 18-627	RH LH	S	Spicer	15"	
8 ⁷ / ₈ "	A	1 ¹ / ₂ " - 10	1 ¹ / ₂ "	17-612 17-613	RH LH	T	Spicer	16 ¹ / ₂ "	Spicer Custom Trunnion Suspension; 1 ¹ / ₂ " tip
8 ⁷ / ₈ "	F	1 ¹ / ₂ " - 10	1 ¹ / ₂ "	18-880 18-881	RH LH	S	Rockwell	15"	"T" Series Brake
8 ¹⁵ / ₁₆ "	A	1 ¹ / ₂ " - 10	1 ¹ / ₂ "	18-728 18-729	RH LH	D	Eaton	16 ¹ / ₂ "	
8 ¹⁵ / ₁₆ "	I	1 ¹ / ₄ " - 10	1 ¹ / ₄ "	18-768 18-769	RH LH	S	Eaton	15"	Single Anchor Pin (SAP)
8 ¹⁵ / ₁₆ "	J	1 ¹ / ₄ " - 10	1 ¹ / ₄ "	18-970 18-971	RH LH	S	Eaton	15"	Extended Service Brake (EST™); Single Anchor Pin (SAP)
9 ¹ / ₃₂ "	A	1 ¹ / ₂ " - 28	1 ¹ / ₂ "	18-646 18-647	RH LH	D	Spicer	16 ¹ / ₂ "	5", 6", and 7" Brakes
9 ¹ / ₁₆ "	A	1 ¹ / ₂ " - 28	1 ¹ / ₂ "	18-850 18-851	RH LH	D	Rockwell	16 ¹ / ₂ "	
9 ¹ / ₁₆ "	B	1 ¹ / ₂ " - 28	1 ¹ / ₂ "	18-506 18-507	RH LH	D	Rockwell	16 ¹ / ₂ "	"Q Plus" Brake
9 ³ / ₃₂ "	A	1 ¹ / ₂ " - 10	1 ¹ / ₂ "	18-794 18-795	RH LH	D	Rockwell	16 ¹ / ₂ "	
9 ¹ / ₈ "	F	1 ¹ / ₂ " - 10	1 ¹ / ₂ "	18-884 18-885	RH LH	S	Rockwell	15"	"T" Series Brake
9 ³ / ₁₆ "	I	1 ¹ / ₄ " - 10	1 ¹ / ₄ "	18-770 18-771	RH LH	S	Eaton	15"	Single Anchor Pin (SAP)
9 ³ / ₁₆ "	J	1 ¹ / ₄ " - 10	1 ¹ / ₄ "	18-972 18-973	RH LH	S	Eaton	15"	Extended Service Brake (EST™); Single Anchor Pin (SAP)
9 ¹ / ₄ "	A	1 ¹ / ₄ " - 10	1 ¹ / ₄ "	18-628 18-629	RH LH	S	Spicer	15"	
9 ¹ / ₄ "	A	1 ¹ / ₂ " - 28	1 ¹ / ₂ "	18-862 18-863	RH LH	D	Rockwell	16 ¹ / ₂ "	
9 ¹ / ₄ "	F	1 ¹ / ₄ " - 10	1 ¹ / ₄ "	18-872 18-873	RH LH	S	Rockwell	15"	"T" Series Brake
9 ¹ / ₄ "	G	1 ¹ / ₄ " - 24	1 ¹ / ₄ "	18-896 18-897	RH LH	S	Rockwell	15"	"Q" Brake; 1 ¹ / ₂ " Offset Backing Plate
9 ¹ / ₄ "	G	1 ¹ / ₄ " - 10	1 ¹ / ₄ "	18-956 18-957	RH LH	S	Rockwell	15"	"T" Series Brake; New Style S-Head
9 ⁵ / ₁₆ "	G	1 ¹ / ₄ " - 24	1 ¹ / ₄ "	18-906 18-907	RH LH	S	Rockwell	15"	"Q" Brake; 2" Offset Backing Plate

*Axle Type: S = Steer, D = Drive, T = Trailer

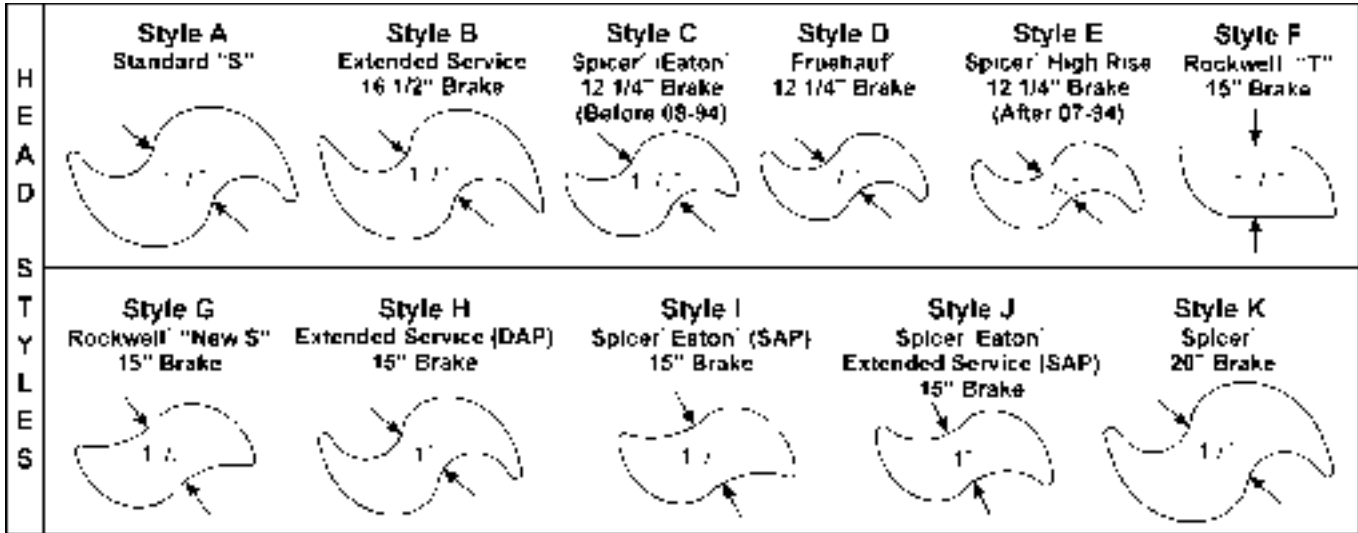

These graphics are for identification purposes only. Dimensions in actual camshafts may vary slightly.

Cam Length	Head Style	Diameter at Spine End & No. of Splines	Diameter at Spider	Spicer Part Number	Side	Axle Type*	Brake Manufacturer	Brake Size	Notes
9 5/16"	H	1 1/2" - 28	1 1/2"	18-936 18-937	RH LH	S	Rockwell	15"	"Q Plus" Brake; Dual Anchor Pin (DAP)
9 7/16"	B	1 1/2" - 28	1 1/2"	18-508 18-509	RH LH	D	Rockwell	16 1/2"	"Q Plus" Brake
9 7/16"	H	1 1/2" - 28	1 1/2"	18-938 18-939	RH LH	S	Rockwell	15"	"Q Plus" Brake; Dual Anchor Pin (DAP)
9 15/32"	G	1 1/4" - 24	1 1/4"	18-898 18-899	RH LH	S	Rockwell	15"	"Q" Brake; 1 1/2" Offset Backing Plate
9 31/64"	A	1 1/2" - 10	1 1/2"	18-782 18-783	RH LH	D	Rockwell	16 1/2"	
9 1/2"	A	1 1/4" - 10	1 1/4"	18-630 18-631	RH LH	S	Spicer	15"	
9 1/2"	A	1 1/2" - 28	1 1/2"	18-864 18-865	RH LH	D	Rockwell	16 1/2"	
9 17/32"	F	1 1/4" - 10	1 1/4"	18-874 18-875	RH LH	S	Rockwell	15"	"T" Series Brake
9 17/32"	G	1 1/4" - 24	1 1/4"	18-900 18-901	RH LH	S	Rockwell	15"	"Q" Brake; 1 1/2" Offset Backing Plate
9 17/32"	G	1 1/4" - 10	1 1/4"	18-958 18-959	RH LH	S	Rockwell	15"	"T" Series Brake; New Style S-Head
9 9/16"	I	1 1/4" - 10	1 1/4"	18-772 18-773	RH LH	S	Eaton	15"	Single Anchor Pin (SAP)
9 9/16"	J	1 1/4" - 10	1 1/4"	18-974 18-975	RH LH	S	Eaton	15"	Extended Service Brake (ES™); Single Anchor Pin (SAP)
9 3/4"	A	1 1/2" - 28	1 1/2"	18-888 18-889	RH LH	D	Rockwell	16 1/2"	
9 25/32"	I	1 1/4" - 10	1 1/4"	18-774 18-775	RH LH	S	Eaton	15"	Single Anchor Pin (SAP)
9 13/16"	A	1 1/2" - 10	1 1/2"	18-730 18-731	RH LH	D	Eaton	16 1/2"	
9 13/16"	F	1 1/4" - 10	1 1/4"	18-876 18-877	RH LH	S	Rockwell	15"	"T" Series Brake

*Axle Type: S = Steer, D = Drive, T = Trailer

Cam Length	Head Style	Diameter at Spline End & No. of Splines	Diameter at Spider	Spicer Part Number	Side	Axle Type*	Brake Manufacturer	Brake Size	Notes
9 13/16"	G	1 1/4" - 10	1 1/4"	18-948 18-949	RH LH	S	Rockwell	15"	"T" Series Brake; New Style S-Head
9 7/8"	B	1 1/2" - 28	1 1/2"	18-672 18-673	RH LH	D	Spicer	16 1/2"	"XL" and "XLII" Brakes; 5", 6" and 7" Brakes
9 7/8"	J	1 1/4" - 10	1 1/4"	18-976 18-977	RH LH	S	Eaton	15"	Extended Service Brake (ESTM); Single Anchor Pin (SAP)
9 15/16"	G	1 1/4" - 24	1 1/4"	18-908 18-909	RH LH	S	Rockwell	15"	"Q" Brake; 2" Offset Backing Plate
10 3/16"	A	1 1/2" - 10	1 1/2"	18-732 18-733	RH LH	D	Eaton	16 1/2"	
10 3/16"	B	1 1/2" - 28	1 1/2"	18-930 18-931	RH LH	D	Rockwell	16 1/2"	"Q Plus" Brake
10 1/4"	A	1 1/2" - 28	1 1/2"	18-710 18-711	RH LH	D	Rockwell	16 1/2"	
10 1/4"	A	1 1/2" - 10	1 1/2"	18-784 18-785	RH LH	D	Rockwell	16 1/2"	
10 13/32"	B	1 1/2" - 28	1 1/2"	18-510 18-511	RH LH	D	Rockwell	16 1/2"	"Q Plus" Brake
10 15/32"	A	1 1/2" - 28	1 1/2"	18-648 18-649	RH LH	D	Spicer	16 1/2"	5", 6" and 7" Brakes
10 15/32"	B	1 1/2" - 28	1 1/2"	18-674 18-675	RH LH	D	Spicer	16 1/2"	"XL" and "XLII" Brakes; 5", 6" and 7" Brakes
10 1/2"	B	1 1/2" - 28	1 1/2"	18-512 18-513	RH LH	D	Rockwell	16 1/2"	"Q Plus" Brake
10 1/2"	A	1 1/2" - 10	1 1/2"	18-734 18-735	RH LH	D	Eaton	16 1/2"	
10 1/2"	A	1 1/2" - 28	1 1/2"	18-826 18-827	RH LH	D	Rockwell	16 1/2"	
10 9/16"	A	1 1/2" - 10	1 1/2"	18-806 18-807	RH LH	D	Rockwell	16 1/2"	
10 9/16"	B	1 1/2" - 10	1 1/2"	18-982 18-983	RH LH	D	Eaton	16 1/2"	Extended Service Brake (ESTM)
10 11/16"	A	1 1/4" - 10	1 1/4"	18-634 18-635	RH LH	S	Spicer	15"	
10 7/8"	A	1 1/2" - 28	1 1/2"	18-828 18-829	RH LH	D	Rockwell	16 1/2"	
10 29/32"	I	1 1/4" - 10	1 1/4"	18-776 18-777	RH LH	S	Eaton	15"	Single Anchor Pin (SAP)
10 29/32"	J	1 1/4" - 10	1 1/4"	18-978 18-979	RH LH	S	Eaton	15"	Extended Service Brake (ESTM); Single Anchor Pin (SAP)
10 15/16"	B	1 1/2" - 28	1 1/2"	18-514 18-515	RH LH	D	Rockwell	16 1/2"	"Q Plus" Brake
11 3/32"	A	1 1/2" - 28	1 1/2"	17-11055 17-11056	LH RH	T	Intraax	16 1/2"	
11 1/8"	B	1 1/2" - 28	1 1/2"	18-516 18-517	RH LH	D	Rockwell	16 1/2"	"Q Plus" Brake
11 1/8"	A	1 1/2" - 10	1 1/2"	18-736 18-737	RH LH	D	Eaton	16 1/2"	
11 1/8"	I	1 1/4" - 10	1 1/4"	18-778 18-779	RH LH	S	Eaton	15"	Single Anchor Pin (SAP)

*Axle Type: S = Steer, D = Drive, T = Trailer

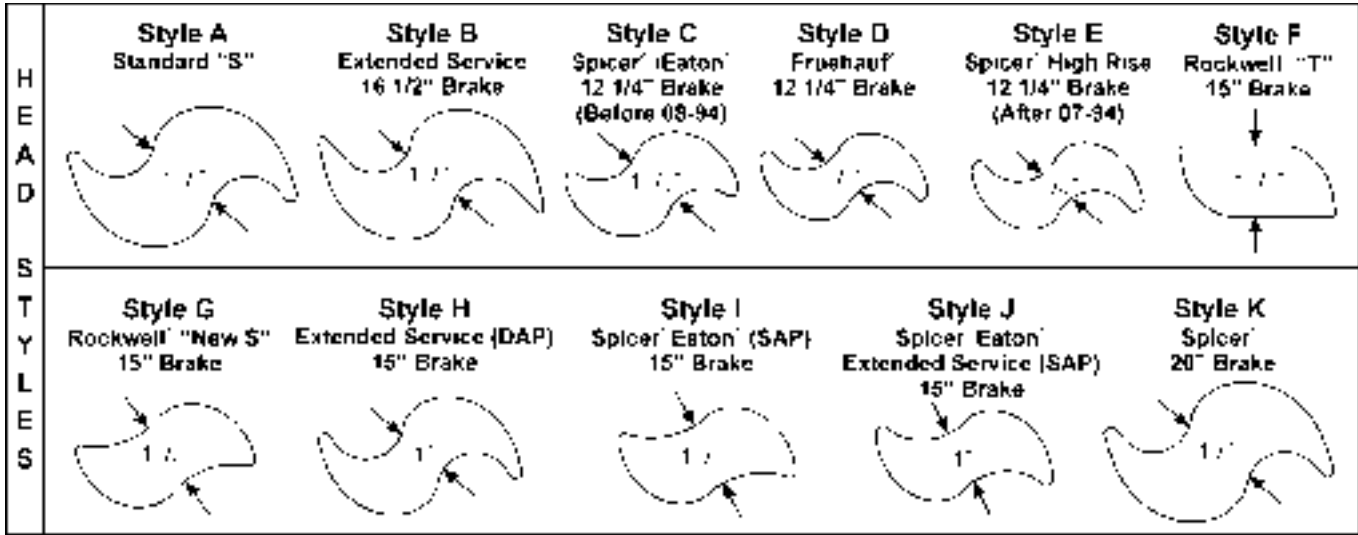

These graphics are for identification purposes only. Dimensions in actual camshafts may vary slightly.

Cam Length	Head Style	Diameter at Spine End & No. of Splines	Diameter at Spider	Spicer Part Number	Side	Axle Type*	Brake Manufacturer	Brake Size	Notes
11 1/8"	A	1 1/2" - 28	1 1/2"	18-798 18-799	RH LH	D	Rockwell	16 1/2"	
11 1/8"	J	1 1/4" - 10	1 1/4"	18-980 18-981	RH LH	S	Eaton	15"	Extended Service Brake (ES™); Single Anchor Pin (SAP)
11 3/16"	A	1 1/2" - 28	1 1/2"	18-650 18-651	RH LH	D	Spicer	16 1/2"	5", 6" and 7" Brakes
11 3/16"	B	1 1/2" - 28	1 1/2"	18-676 18-677	RH LH	D	Spicer	16 1/2"	"XL" and "XLII" Brakes; 5", 6" and 7" Brakes
11 1/4"	A	1 1/2" - 28	1 1/2"	18-830 18-831	RH LH	D	Rockwell	16 1/2"	
11 9/32"	A	1 1/2" - 10	1 1/2"	18-808 18-809	RH LH	D	Rockwell	16 1/2"	
11 1/2"	A	1 1/2" - 28	1 1/2"	18-652 18-653	RH LH	D	Spicer	16 1/2"	5", 6" and 7" Brakes
11 1/2"	A	1 1/2" - 10	1 1/2"	18-738 18-739	RH LH	D	Eaton	16 1/2"	
11 1/2"	A	1 1/2" - 10	1 1/2"	18-810 18-811	RH LH	D	Rockwell	16 1/2"	
11 1/2"	A	1 1/2" - 28	1 1/2"	18-832 18-833	RH LH	D	Rockwell	16 1/2"	
11 1/2"	B	1 1/2" - 10	1 1/2"	18-942 18-943	RH LH	D	Eaton	16 1/2"	Extended Service Brake (ES™)
11 9/16"	B	1 1/2" - 28	1 1/2"	18-518 18-519	RH LH	D	Rockwell	16 1/2"	"Q Plus" Brake
11 5/8"	A	1 1/2" - 28	1 1/2"	18-866 18-867	RH LH	D	Rockwell	16 1/2"	
11 11/16"	B	1 1/2" - 28	1 1/2"	18-520 18-521	RH LH	D	Rockwell	16 1/2"	"Q Plus" Brake
11 3/4"	A	1 1/2" - 10	1 1/2"	18-786 18-787	RH LH	D	Rockwell	16 1/2"	
11 3/4"	F	1 1/2" - 10	1 1/2"	18-886 18-887	RH LH	S	Rockwell	15"	"T" Series Brake

*Axle Type: S = Steer, D = Drive, T = Trailer

Cam Length	Head Style	Diameter at Spline End & No. of Splines	Diameter at Spider	Spicer Part Number	Side	Axle Type*	Brake Manufacturer	Brake Size	Notes
11 15/16"	B	1 1/2" - 28	1 1/2"	18-522 18-523	RH LH	D	Rockwell	16 1/2"	"Q Plus" Brake
12 1/16"	A	1 1/2" - 10	1 1/2"	18-852 18-853	RH LH	D	Rockwell	16 1/2"	
12 1/8"	A	1 1/2" - 10	1 1/2"	18-708 18-709	RH LH	D	Bendix	16 1/2"	Brazilian Brake
12 15/64"	A	1 1/2" - 28	1 1/2"	18-654 18-655	RH LH	D	Spicer	16 1/2"	5", 6" and 7" Brakes
12 7/16"	B	1 1/2" - 28	1 1/2"	18-524 18-525	RH LH	D	Rockwell	16 1/2"	"Q Plus" Brake
12 7/16"	B	1 1/2" - 28	1 1/2"	18-678 18-679	RH LH	D	Spicer	16 1/2"	"XL" and "XLII" Brakes; 5", 6" and 7" Brakes
12 7/16"	A	1 1/2" - 10	1 1/2"	18-740 18-741	RH LH	D	Eaton	16 1/2"	
12 1/2"	A	1 1/2" - 10	1 1/2"	18-812 18-813	RH LH	D	Rockwell	16 1/2"	
12 1/2"	A	1 1/2" - 28	1 1/2"	18-868 18-869	RH LH	D	Rockwell	16 1/2"	
12 1/2"	B	1 1/2" - 10	1 1/2"	18-984 18-985	RH LH	D	Eaton	16 1/2"	Extended Service Brake (ESTM)
12 15/16"	B	1 1/2" - 28	1 1/2"	18-526 18-527	RH LH	D	Rockwell	16 1/2"	"Q Plus" Brake
12 15/16"	A	1 1/2" - 28	1 1/2"	18-656 18-657	RH LH	D	Spicer	16 1/2"	5", 6" and 7" Brakes
12 15/16"	A	1 1/2" - 28	1 1/2"	18-836 18-837	RH LH	D	Rockwell	16 1/2"	
13"	A	1 1/2" - 10	1 1/2"	18-748 18-749	RH LH	D	Eaton	16 1/2"	
13"	A	1 1/2" - 10	1 1/2"	18-814 18-815	RH LH	D	Rockwell	16 1/2"	
13"	B	1 1/2" - 10	1 1/2"	18-946 18-947	RH LH	D	Eaton	16 1/2"	Extended Service Brake (ESTM)
13 1/8"	A	1 1/2" - 28	1 1/2"	18-658 18-659	RH LH	D	Spicer	16 1/2"	5", 6" and 7" Brakes
13 3/16"	A	1 1/2" - 28	1 1/2"	18-820 18-821	RH LH	D	Rockwell	16 1/2"	
13 7/32"	B	1 1/2" - 28	1 1/2"	18-528 18-529	RH LH	D	Rockwell	16 1/2"	"Q Plus" Brake
13 9/32"	B	1 1/2" - 28	1 1/2"	18-680 18-681	RH LH	D	Spicer	16 1/2"	"XL" and "XLII" Brakes; 5", 6" and 7" Brakes
13 7/16"	B	1 1/2" - 28	1 1/2"	18-530 18-531	RH LH	D	Rockwell	16 1/2"	"Q Plus" Brake
13 7/16"	A	1 1/2" - 28	1 1/2"	18-660 18-661	RH LH	D	Spicer	16 1/2"	5", 6" and 7" Brakes
13 7/16"	A	1 1/2" - 10	1 1/2"	18-742 18-743	RH LH	D	Eaton	16 1/2"	
13 7/16"	A	1 1/2" - 28	1 1/2"	18-822 18-823	RH LH	D	Rockwell	16 1/2"	
13 15/32"	B	1 1/2" - 10	1 1/2"	18-994 18-995	RH LH	D	Eaton	16 1/2" & 18"	Extended Service Brake (ESTM)

*Axle Type: S = Steer, D = Drive, T = Trailer

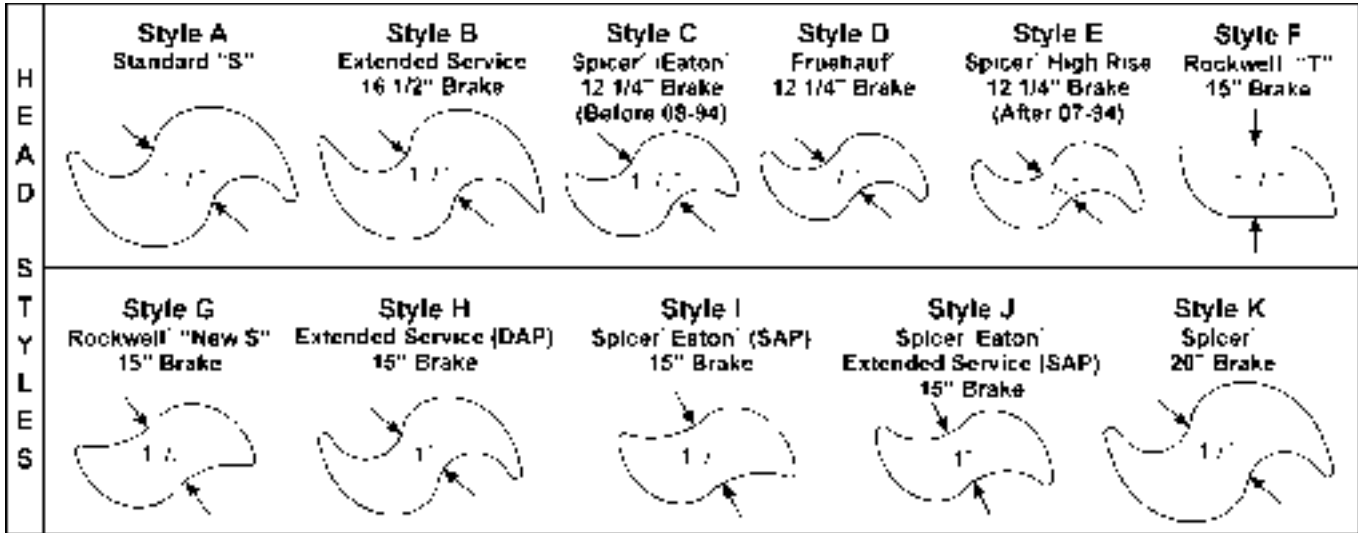

These graphics are for identification purposes only. Dimensions in actual camshafts may vary slightly.

Cam Length	Head Style	Diameter at Spine End & No. of Splines	Diameter at Spider	Spicer Part Number	Side	Axle Type*	Brake Manufacturer	Brake Size	Notes
13 1/2"	B	1 1/2" - 28	1 1/2"	18-532 18-533	RH LH	D	Rockwell	16 1/2"	"Q Plus" Brake
13 21/32"	A	1 1/2" - 10	1 1/2"	18-724 18-725	RH LH	D	Rockwell	16 1/2"	
14 1/16"	A	1 1/2" - 28	1 1/2"	18-834 18-835	RH LH	D	Rockwell	16 1/2"	
14 3/32"	B	1 1/2" - 28	1 1/2"	18-534 18-535	RH LH	D	Rockwell	16 1/2"	"Q Plus" Brake
14 1/8"	A	1 1/2" - 10	1 1/2"	18-816 18-817	RH LH	D	Rockwell	16 1/2"	
14 1/4"	A	1 1/2" - 10	1 1/2"	18-746 18-747	RH LH	D	Eaton	16 1/2"	
14 1/4"	B	1 1/2" - 10	1 1/2"	18-944 18-945	RH LH	D	Eaton	16 1/2"	Extended Service Brake (ES™)
14 9/16"	B	1 1/2" - 28	1 1/2"	18-682 18-683	RH LH	D	Spicer	16 1/2"	"XL" and "XLII" Brakes; 5", 6" and 7" Brakes
14 9/16"	A	1 1/2" - 10	1 1/2"	18-754 18-755	RH LH	D	Eaton	16 1/2"	
14 19/32"	B	1 1/2" - 28	1 1/2"	18-536 18-537	RH LH	D	Rockwell	16 1/2"	"Q Plus" Brake
14 19/32"	A	1 1/2" - 28	1 1/2"	18-780 18-781	RH LH	D	Rockwell	16 1/2"	
14 3/4"	B	1 1/2" - 28	1 1/2"	18-538 18-539	RH LH	D	Rockwell	16 1/2"	"Q Plus" Brake
14 7/8"	A	1 1/2" - 10	1 1/2"	18-790 18-791	RH LH	D	Rockwell	16 1/2"	
15"	A	1 1/2" - 10	1 1/2"	18-744 18-745	RH LH	D	Eaton	16 1/2"	
15"	A	1 1/2" - 28	1 1/2"	18-878 18-879	RH LH	D	Rockwell	16 1/2"	
15 1/16"	B	1 1/2" - 10	1 1/2"	18-996 18-997	RH LH	D	Eaton	16 1/2" & 18"	Extended Service Brake (ES™)

*Axle Type: S = Steer, D = Drive, T = Trailer

Cam Length	Head Style	Diameter at Spline End & No. of Splines	Diameter at Spider	Spicer Part Number	Side	Axle Type*	Brake Manufacturer	Brake Size	Notes
15 3/16"	B	1 1/2" - 28	1 1/2"	18-540 18-541	RH LH	D	Rockwell	16 1/2"	"Q Plus" Brake
15 3/16"	A	1 1/2" - 28	1 1/2"	18-712 18-713	RH LH	D	Rockwell	16 1/2"	
15 1/4"	B	1 1/2" - 10	1 1/2"	18-1127 18-1128	LH RH	D	Eaton	16 1/2" & 18"	Extended Service Brake (ESTM)
15 1/2"	A	1 1/2" - 28	1 1/2"	18-714 18-715	RH LH	D	Rockwell	16 1/2"	
15 19/32"	B	1 1/2" - 28	1 1/2"	18-684 18-685	RH LH	D	Spicer	16 1/2"	"XL" and "XLII" Brakes; 5", 6" and 7" Brakes
15 5/8"	A	1 1/2" - 10	1 1/2"	17-560 17-561	RH LH	T	Multi-App.	16 1/2"	
15 23/32"	B	1 1/2" - 28	1 1/2"	18-542 18-543	RH LH	D	Rockwell	16 1/2"	"Q Plus" Brake
15 23/32"	A	1 1/2" - 28	1 1/2"	18-716 18-717	RH LH	D	Rockwell	16 1/2"	
15 3/4"	A	1 1/2" - 10	1 1/2"	18-818 18-819	RH LH	D	Rockwell	16 1/2"	
15 7/8"	A	1 1/2" - 10	1 1/2"	18-750 18-751	RH LH	D	Eaton	16 1/2"	
16 1/8"	E	1 1/2" - 28	1 5/8"	17-400 17-401	RH LH	T	Spicer	12 1/4"	Axles Manufactured After February 1996; Double Groove
16 1/8"	A	1 1/2" - 28	1 5/8"	17-614 17-615	RH LH	T	Fruehauf	16 1/2"	"Pro-Par" Type Axle
16 1/8"	A	1 19/32" - 37	1 5/8"	17-620 17-621	RH LH	T	Fruehauf	16 1/2"	"Pro-Par" Type Axle
16 1/8"	E	1 1/2" - 10	1 1/2"	17-734 17-735	RH LH	T	Spicer	12 1/4"	Axles Manufactured After July 1994; Double Groove
16 1/8"	E	1 1/2" - 28	1 1/2"	17-784 17-785	RH LH	T	Spicer	12 1/4"	Axles Manufactured After July 1994; Double Groove
16 1/8"	E	1 1/2" - 10	1 5/8"	17-960 17-961	RH LH	T	Spicer	12 1/4"	Axles Manufactured After February 1996; Double Groove
16 3/16"	D	1 19/32" - 37	1 5/8"	17-624 17-625	RH LH	T	Fruehauf	12 1/4"	"Pro-Par" Type Axle
16 5/16"	A	1 1/2" - 10	1 1/2"	17-570 17-571	RH LH	T	Multi-App.	16 1/2"	
16 5/16"	B	1 1/2" - 10	1 1/2"	17-540 17-541	RH LH	T	Spicer	16 1/2"	"XL" Brake; Double Groove;
16 5/16"	B	1 1/2" - 10	1 5/8"	17-840 17-841	RH LH	T	Spicer	16 1/2"	Axles Manufactured After September 1995; "XL" Brake; Double Groove
16 3/8"	E	1 1/2" - 28	1 1/2"	17-11057 17-11058	LH RH	T	Dexter	12 1/4"	
16 1/2"	B	1 1/2" - 28	1 1/2"	17-520 17-521	RH LH	T	Spicer	16 1/2"	"XL" Brake
16 1/2"	B	1 1/2" - 10	1 1/2"	17-542 17-543	RH LH	T	Spicer	16 1/2"	"XL" Brake; Double Groove
16 1/2"	A	1 1/2" - 10	1 1/2"	17-576 17-577	RH LH	T	Multi-App.	16 1/2"	
16 1/2"	B	1 1/2" - 10	1 5/8"	17-842 17-843	RH LH	T	Spicer	16 1/2"	Axles Manufactured After September 1995; "XL" Brake; Double Groove

*Axle Type: S = Steer, D = Drive, T = Trailer

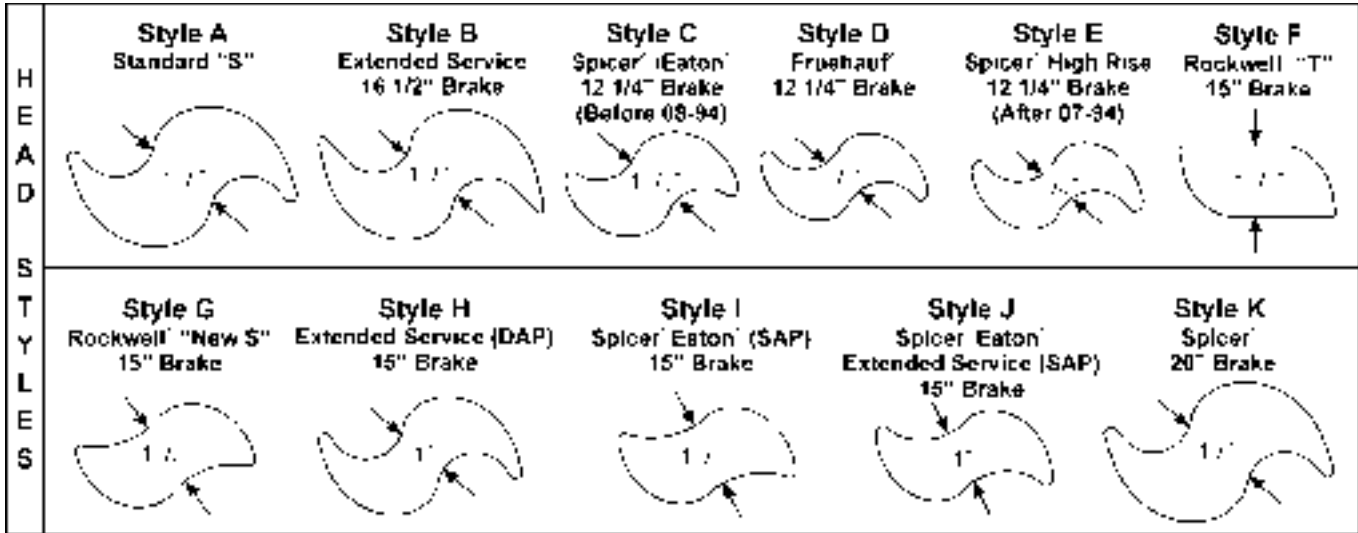

These graphics are for identification purposes only. Dimensions in actual camshafts may vary slightly.

Cam Length	Head Style	Diameter at Spine End & No. of Splines	Diameter at Spider	Spicer Part Number	Side	Axle Type*	Brake Manufacturer	Brake Size	Notes
16 1/2"	B	1 1/2" - 28	1 5/8"	17-912 17-913	RH LH	T	Spicer	16 1/2"	Axles Manufactured After September 1995; "XL" Brake
17 1/16"	B	1 1/2" - 28	1 1/2"	18-688 18-689	RH LH	D	Spicer	16 1/2"	"XL" and "XLII" Brakes; 5", 6" and 7" Brakes
17 1/8"	B	1 1/2" - 28	1 1/2"	17-530 17-531	RH LH	T	Spicer	16 1/2"	"XL" Brake
17 5/16"	B	1 1/2" - 28	1 5/8"	17-720 17-721	RH LH	T	Rockwell	16 1/2"	"Q Plus" Brake; Forged or Fabricated Spiders
17 3/8"	A	1 1/2" - 28	1 1/2"	17-478 17-479	RH LH	T	Spicer	16 1/2"	
17 3/8"	B	1 1/2" - 28	1 1/2"	17-512 17-513	RH LH	T	Spicer	16 1/2"	"XL" Brake
17 3/8"	B	1 1/2" - 10	1 1/2"	17-516 17-517	RH LH	T	Spicer	16 1/2"	"XL" Brake; Double Groove
17 3/8"	A	1 1/2" - 10	1 1/2"	17-568 17-569	RH LH	T	Multi-App.	16 1/2"	Double Groove
17 3/8"	A	1 1/2" - 28	1 5/8"	17-626 17-627	RH LH	T	Rockwell	16 1/2"	Rockwell 4000-6000 Series; Cast Spider
17 3/8"	A	1 1/2" - 10	1 5/8"	17-640 17-641	RH LH	T	Rockwell	16 1/2"	Rockwell 4000-6000 Series; Cast Spider
17 3/8"	A	1 1/2" - 28	1 5/8"	17-656 17-657	RH LH	T	Rockwell	16 1/2"	Rockwell 4000-6000 Series; Fabricated Spider
17 3/8"	E	1 1/2" - 10	1 1/2"	17-736 17-737	RH LH	T	Spicer	12 1/4"	Axles Manufactured After July 1994; Double Groove
17 3/8"	B	1 1/2" - 28	1 5/8"	17-810 17-811	RH LH	T	Rockwell	16 1/2"	Rockwell 4000-6000 Series; "Q Plus" Brake; Cast Spider
17 3/8"	B	1 1/2" - 10	1 5/8"	17-844 17-845	RH LH	T	Spicer	16 1/2"	Axles Manufactured After September 1995; "XL" Brake; Double Groove
17 3/8"	B	1 1/2" - 28	1 5/8"	17-914 17-915	RH LH	T	Spicer	16 1/2"	Axles Manufactured After September 1995; "XL" Brake
17 3/8"	E	1 1/2" - 10	1 5/8"	17-962 17-963	RH LH	T	Spicer	12 1/4"	Axles Manufactured After February 1996; Double Groove

*Axle Type: S = Steer, D = Drive, T = Trailer

Cam Length	Head Style	Diameter at Spline End & No. of Splines	Diameter at Spider	Spicer Part Number	Side	Axle Type*	Brake Manufacturer	Brake Size	Notes
17 3/4"	B	1 1/2" - 10	1 1/2"	17-544 17-545	RH LH	T	Spicer	16 1/2"	"XL" Brake; Double Groove
17 3/4"	A	1 1/2" - 10	1 1/2"	17-572 17-573	RH LH	T	Multi-App.	16 1/2"	
17 3/4"	B	1 1/2" - 10	1 5/8"	17-846 17-847	RH LH	T	Spicer	16 1/2"	Axles Manufactured After September 1995; "XL" Brake; Double Groove;
18"	E	1 1/2" - 28	1 5/8"	17-404 17-405	RH LH	T	Spicer	12 1/4"	Axles Manufactured After February 1996; Double Groove
18"	C	1 1/2" - 10	1 1/2"	17-678 17-679	RH LH	T	Spicer	12 1/4"	Axles Manufactured Before August 1994; Double Groove
18"	E	1 1/2" - 10	1 1/2"	17-740 17-741	RH LH	T	Spicer	12 1/4"	Axles Manufactured After July 1994; Double Groove
18"	E	1 1/2" - 28	1 1/2"	17-788 17-789	RH LH	T	Spicer	12 1/4"	Axles Manufactured After July 1994; Double Groove
18"	E	1 1/2" - 10	1 5/8"	17-964 17-965	RH LH	T	Spicer	12 1/4"	Axles Manufactured After February 1996; Double Groove
18 3/8"	B	1 1/2" - 10	1 1/2"	17-546 17-547	RH LH	T	Spicer	16 1/2"	"XL" Brake; Double Groove
18 3/8"	A	1 1/2" - 10	1 1/2"	17-566 17-567	RH LH	T	Multi-App.	16 1/2"	
18 3/8"	B	1 1/2" - 10	1 5/8"	17-848 17-849	RH LH	T	Spicer	16 1/2"	Axles Manufactured After September 1995; "XL"; Double Groove
18 5/8"	B	1 1/2" - 10	1 1/2"	17-548 17-549	RH LH	T	Spicer	16 1/2"	"XL" Brake; Double Groove
18 5/8"	A	1 1/2" - 10	1 1/2"	17-578 17-579	RH LH	T	Multi-App.	16 1/2"	
18 5/8"	B	1 1/2" - 10	1 5/8"	17-850 17-851	RH LH	T	Spicer	16 1/2"	Axles Manufactured After September 1995; "XL"; Double Groove
18 7/8"	E	1 1/2" - 28	1 5/8"	17-406 17-407	RH LH	T	Spicer	12 1/4"	Axles Manufactured After February 1996; Double Groove
18 7/8"	C	1 1/2" - 10	1 1/2"	17-676 17-677	RH LH	T	Spicer	12 1/4"	Axles Manufactured Before August 1994; Double Groove
18 7/8"	E	1 1/2" - 10	1 1/2"	17-744 17-745	RH LH	T	Spicer	12 1/4"	Axles Manufactured After July 1994; Double Groove
18 7/8"	E	1 1/2" - 28	1 1/2"	17-792 17-793	RH LH	T	Spicer	12 1/4"	Axles Manufactured After July 1994; Double Groove
18 7/8"	E	1 1/2" - 10	1 5/8"	17-966 17-967	RH LH	T	Spicer	12 1/4"	Axles Manufactured After February 1996; Double Groove
19 3/8"	B	1 1/2" - 10	1 5/8"	17-460 17-461	RH LH	T	Eaton	16 1/2"	Extended Service Brake (EST™)
19 3/8"	B	1 1/2" - 28	1 5/8"	17-470 17-471	RH LH	T	Eaton	16 1/2"	Extended Service Brake (EST™)
19 1/2"	B	1 1/2" - 10	1 1/2"	17-536 17-537	RH LH	T	Spicer	16 1/2"	"XL" Brake; Double Groove
19 1/2"	A	1 1/2" - 10	1 5/8"	17-634 17-635	RH LH	T	Eaton	16 1/2"	501 Series
19 1/2"	A	1 1/2" - 10	1 1/2"	18-752 18-753	RH LH	D	Eaton	16 1/2"	Air Lift Tag Axle
20"	C	1 1/2" - 10	1 1/2"	17-688 17-689	RH LH	T	Spicer	12 1/4"	Axles Manufactured Before August 1994; Double Groove

*Axle Type: S = Steer, D = Drive, T = Trailer

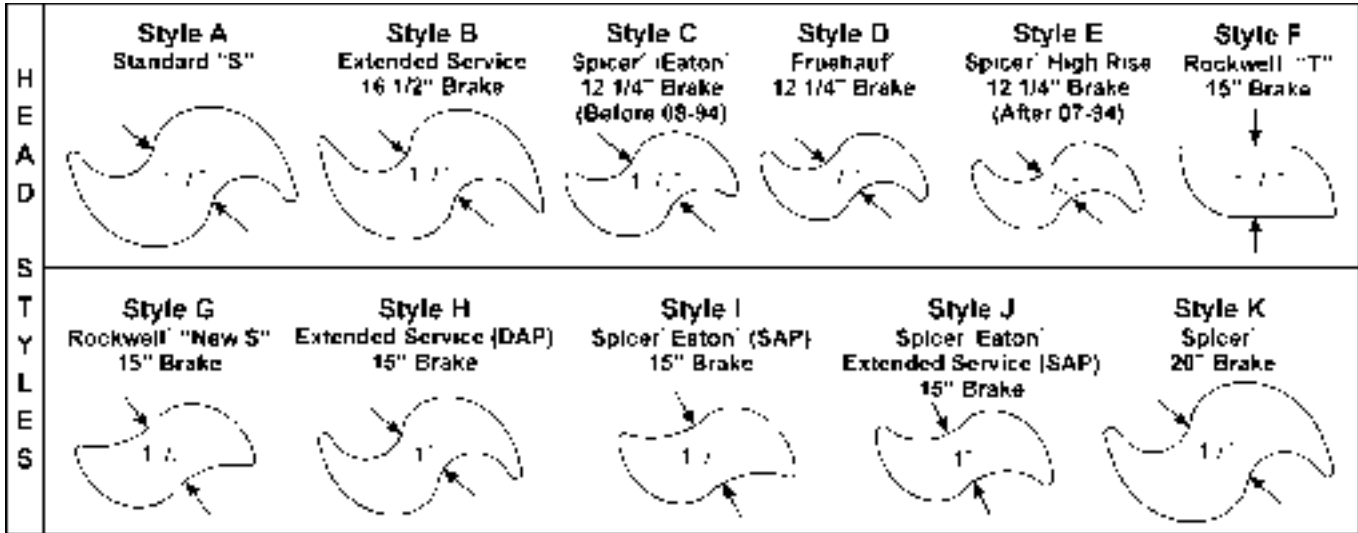

These graphics are for identification purposes only. Dimensions in actual camshafts may vary slightly.

Cam Length	Head Style	Diameter at Spine End & No. of Splines	Diameter at Spider	Spicer Part Number	Side	Axle Type*	Brake Manufacturer	Brake Size	Notes
20"	E	1 1/2" - 10	1 1/2"	17-746 17-747	RH LH	T	Spicer	12 1/4"	Axles Manufactured After July 1994; Double Groove
20"	E	1 1/2" - 10	1 5/8"	17-968 17-969	RH LH	T	Spicer	12 1/4"	Axles Manufactured After February 1996; Double Groove
20 7/32"	A	1 1/2" - 28	1 5/8"	17-638 17-639	RH LH	T	Eaton	16 1/2"	501 Series
20 5/16"	E	1 1/2" - 28	1 1/2"	17-11059 17-11060	LH RH	T	Dexter	12 1/4"	
20 5/16"	C	1 1/2" - 10	1 1/2"	17-682 17-683	RH LH	T	Eaton/ Shuler	12 1/4"	Double Groove
20 5/16"	E	1 1/2" - 28	1 5/8"	17-700 17-701	RH LH	T	Rockwell	12 1/4"	
20 5/16"	E	1 1/2" - 10	1 5/8"	17-714 17-715	RH LH	T	Rockwell	12 1/4"	
20 5/16"	E	1 1/2" - 10	1 1/2"	17-748 17-749	RH LH	T	Spicer	12 1/4"	Axles Manufactured After July 1994; Double Groove
20 5/16"	E	1 1/2" - 10	1 5/8"	17-970 17-971	RH LH	T	Spicer	12 1/4"	Axles Manufactured After February 1996; Double Groove
20 3/8"	A	1 1/2" - 10	1 1/2"	17-11071 17-11072	LH RH	T	Eaton/ Shuler	16 1/2"	Double Groove
20 3/8"	E	1 1/2" - 28	1 5/8"	17-408 17-409	RH LH	T	Spicer	12 1/4"	Axles Manufactured After February 1996; Double Groove
20 3/8"	A	1 1/2" - 28	1 1/2"	17-480 17-481	RH LH	T	Spicer	16 1/2"	
20 3/8"	B	1 1/2" - 28	1 1/2"	17-500 17-501	RH LH	T	Spicer	16 1/2"	"XL" Brake
20 3/8"	B	1 1/2" - 10	1 1/2"	17-504 17-505	RH LH	T	Spicer	16 1/2"	"XL" Brake; Double Groove
20 3/8"	A	1 1/2" - 10	1 1/2"	17-580 17-581	RH LH	T	Multi-App.	16 1/2"	Double Groove
20 3/8"	K	1 3/4" - 10	1 3/4"	17-670 17-671	RH LH	T	Spicer	20"	Severe Duty; Cast Iron Shoe

*Axle Type: S = Steer, D = Drive, T = Trailer

Cam Length	Head Style	Diameter at Spline End & No. of Splines	Diameter at Spider	Spicer Part Number	Side	Axle Type*	Brake Manufacturer	Brake Size	Notes
20 3/8"	E	1 1/2" - 28	1 1/2"	17-794 17-795	RH LH	T	Spicer	12 1/4"	Axles Manufactured After July 1994; Double Groove
20 3/8"	B	1 1/2" - 10	1 5/8"	17-852 17-853	RH LH	T	Spicer	16 1/2"	Axles Manufactured After September 1995; "XL" Brake; Double Groove
20 3/8"	B	1 1/2" - 28	1 5/8"	17-920 17-921	RH LH	T	Spicer	16 1/2"	Axles Manufactured After September 1995; "XL" Brake
20 7/16"	B	1 1/2" - 28	1 5/8"	17-722 17-723	RH LH	T	Rockwell	16 1/2"	"Q Plus" Brake; Forged or Fabricated Spiders
20 15/32"	A	1 1/2" - 10	1 5/8"	17-632 17-633	RH LH	T	Rockwell	16 1/2"	Rockwell 4000-6000 Series; Cast Spider
20 1/2"	E	1 1/2" - 28	1 5/8"	17-402 17-403	RH LH	T	Spicer	12 1/4"	Axles Manufactured After February 1996; Double Groove
20 1/2"	A	1 1/2" - 28	1 5/8"	17-628 17-629	RH LH	T	Rockwell	16 1/2"	Rockwell 4000-6000 Series; Cast Spider
20 1/2"	A	1 1/2" - 28	1 5/8"	17-658 17-659	RH LH	T	Rockwell	16 1/2"	Rockwell 4000-6000 Series; Fabricated Spider
20 1/2"	C	1 1/2" - 10	1 1/2"	17-680 17-681	RH LH	T	Spicer	12 1/4"	Axles Manufactured Before August 1994; Double Groove
20 1/2"	E	1 1/2" - 10	1 1/2"	17-750 17-751	RH LH	T	Spicer	12 1/4"	Axles Manufactured After July 1994; Double Groove
20 1/2"	B	1 1/2" - 28	1 5/8"	17-812 17-813	RH LH	T	Rockwell	16 1/2"	Rockwell 4000-6000 Series; "Q Plus" Brake; Cast Spider
20 1/2"	E	1 1/2" - 10	1 5/8"	17-972 17-973	RH LH	T	Spicer	12 1/4"	Axles Manufactured After February 1996; Double Groove
21 1/8"	E	1 1/2" - 28	1 1/2"	17-11061 17-11062	LH RH	T	Dexter	12 1/4"	
21 1/8"	E	1 1/2" - 28	1 5/8"	17-410 17-411	RH LH	T	Spicer	12 1/4"	Axles Manufactured After July 1994; Double Groove
21 1/8"	C	1 1/2" - 28	1 1/2"	17-438 17-439	RH LH	T	Spicer	12 1/4"	Axles Manufactured Before August 1994; Double Groove
21 1/8"	B	1 1/2" - 10	1 1/2"	17-550 17-551	RH LH	T	Spicer	16 1/2"	"XL" Brake; Double Groove
21 1/8"	A	1 1/2" - 10	1 1/2"	17-582 17-583	RH LH	T	Multi-App.	16 1/2"	
21 1/8"	A	1 19/32" - 37	1 5/8"	17-622 17-623	RH LH	T	Fruehauf	16 1/2"	"Pro-Par" Type Axle; Air Ride
21 1/8"	C	1 1/2" - 10	1 1/2"	17-684 17-685	RH LH	T	Spicer	12 1/4"	Axles Manufactured Before August 1994; Double Groove
21 1/8"	E	1 1/2" - 10	1 1/2"	17-752 17-753	RH LH	T	Spicer	12 1/4"	Axles Manufactured After July 1994; Double Groove
21 1/8"	E	1 1/2" - 28	1 1/2"	17-780 17-781	RH LH	T	Spicer	12 1/4"	Axles Manufactured After July 1994; Double Groove
21 1/8"	B	1 1/2" - 10	1 5/8"	17-854 17-855	RH LH	T	Spicer	16 1/2"	Axles Manufactured After September 1995; "XL" Brake; Double Groove
21 1/8"	E	1 1/2" - 10	1 5/8"	17-974 17-975	RH LH	T	Spicer	12 1/4"	Axles Manufactured After February 1996; Double Groove
21 3/16"	D	1 19/32" - 37	1 5/8"	17-618 17-619	RH LH	T	Fruehauf	12 1/4"	"Pro-Par" Type Axle; Air Ride
21 1/4"	E	1 1/2" - 28	1 5/8"	17-414 17-415	RH LH	T	Spicer	12 1/4"	Axles Manufactured After February 1996; Double Groove

*Axle Type: S = Steer, D = Drive, T = Trailer

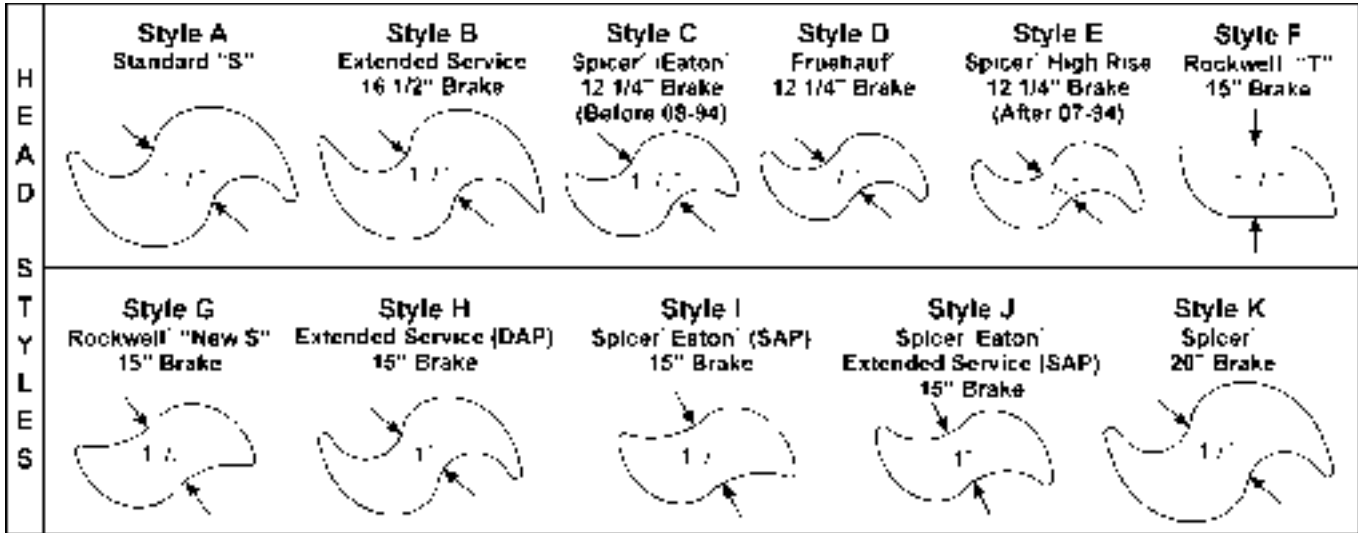

These graphics are for identification purposes only. Dimensions in actual camshafts may vary slightly.

Cam Length	Head Style	Diameter at Spine End & No. of Splines	Diameter at Spider	Spicer Part Number	Side	Axle Type*	Brake Manufacturer	Brake Size	Notes
21 1/4"	C	1 1/2" - 10	1 1/2"	17-686 17-687	RH LH	T	Spicer	12 1/4"	Axles Manufactured Before August 1994; Double Groove
21 1/4"	E	1 1/2" - 10	1 1/2"	17-754 17-755	RH LH	T	Spicer	12 1/4"	Axles Manufactured After July 1994; Double Groove
21 1/4"	E	1 1/2" - 28	1 1/2"	17-786 17-787	RH LH	T	Spicer	12 1/4"	Axles Manufactured After July 1994; Double Groove
21 1/4"	E	1 1/2" - 10	1 5/8"	17-976 17-977	RH LH	T	Spicer	12 1/4"	Axles Manufactured After February 1996; Double Groove
21 3/8"	B	1 1/2" - 28	1 5/8"	17-922 17-923	RH LH	T	Spicer	16 1/2"	"XL" Brake
22"	E	1 1/2" - 28	1 5/8"	17-412 17-413	RH LH	T	Spicer	12 1/4"	Axles Manufactured After February 1996; Double Groove
22"	B	1 1/2" - 10	1 1/2"	17-562 17-563	RH LH	T	Spicer	16 1/2"	"XL" Brake; Double Groove
22"	C	1 1/2" - 10	1 1/2"	17-692 17-693	RH LH	T	Spicer	12 1/4"	Axles Manufactured Before August 1994; Double Groove
22"	E	1 1/2" - 10	1 1/2"	17-756 17-757	RH LH	T	Spicer	12 1/4"	Axles Manufactured After July 1994; Double Groove
22"	E	1 1/2" - 28	1 1/2"	17-796 17-797	RH LH	T	Spicer	12 1/4"	Axles Manufactured After July 1994; Double Groove
22"	B	1 1/2" - 10	1 5/8"	17-856 17-857	RH LH	T	Spicer	16 1/2"	Axles Manufactured After September 1995; "XL" Brake; Double Groove
22"	E	1 1/2" - 10	1 5/8"	17-978 17-979	RH LH	T	Spicer	12 1/4"	Axles Manufactured After February 1996; Double Groove
22 1/16"	A	1 1/2" - 10	1 1/2"	17-598 17-599	RH LH	T	Multi-App.	16 1/2"	Double Groove
22 5/16"	E	1 1/2" - 28	1 1/2"	17-11063 17-11064	LH RH	T	Dexter	12 1/4"	
22 5/16"	C	1 1/2" - 10	1 1/2"	17-698 17-699	RH LH	T	Eaton/ Shuler	12 1/4"	Double Groove
22 5/16"	E	1 1/2" - 10	1 1/2"	17-758 17-759	RH LH	T	Spicer	12 1/4"	Axles Manufactured After July 1994; Double Groove

*Axle Type: S = Steer, D = Drive, T = Trailer

Cam Length	Head Style	Diameter at Spline End & No. of Splines	Diameter at Spider	Spicer Part Number	Side	Axle Type*	Brake Manufacturer	Brake Size	Notes
22 5/16"	E	1 1/2" - 10	1 5/8"	17-980 17-981	RH LH	T	Spicer	12 1/4"	Axles Manufactured After February 1996; Double Groove
22 3/8"	A	1 1/2" - 10	1 1/2"	17-584 17-585	RH LH	T	Multi-App.	16 1/2"	
22 3/8"	B	1 1/2" - 28	1 5/8"	17-932 17-933	RH LH	T	Spicer	16 1/2"	"XL" Brake
22 5/8"	B	1 1/2" - 28	1 1/2"	17-524 17-525	RH LH	T	Spicer	16 1/2"	"XL" Brake
22 5/8"	B	1 1/2" - 10	1 1/2"	17-552 17-553	RH LH	T	Spicer	16 1/2"	"XL" Brake; Double Groove
22 5/8"	B	1 1/2" - 10	1 5/8"	17-858 17-859	RH LH	T	Spicer	16 1/2"	Axles Manufactured After September 1995; "XL"; Double Groove
22 5/8"	B	1 1/2" - 28	1 5/8"	17-924 17-925	RH LH	T	Spicer	16 1/2"	Axles Manufactured After September 1995; "XL";
22 7/8"	A	1 1/2" - 28	1 1/2"	17-484 17-485	RH LH	T	Spicer	16 1/2"	
22 7/8"	B	1 1/2" - 28	1 1/2"	17-510 17-511	RH LH	T	Spicer	16 1/2"	"XL" Brake
22 7/8"	B	1 1/2" - 10	1 1/2"	17-518 17-519	RH LH	T	Spicer	16 1/2"	"XL" Brake; Double Groove
22 7/8"	A	1 1/2" - 10	1 1/2"	17-594 17-595	RH RH	T	Multi-App.	16 1/2"	
22 7/8"	B	1 1/2" - 10	1 5/8"	17-860 17-861	RH LH	T	Spicer	16 1/2"	Axles Manufactured After September 1995; "XL" Brake; Double Groove
22 7/8"	B	1 1/2" - 28	1 5/8"	17-926 17-927	RH LH	T	Spicer	16 1/2"	Axles Manufactured After September 1995; "XL" Brake
23 1/8"	E	1 1/2" - 28	1 5/8"	17-416 17-417	RH LH	T	Spicer	12 1/4"	Axles Manufactured After February 1996; Double Groove
23 1/8"	C	1 1/2" - 28	1 1/2"	17-442 17-443	RH LH	T	Spicer	12 1/4"	Axles Manufactured Before August 1994; Double Groove
23 1/8"	E	1 1/2" - 10	1 1/2"	17-738 17-739	RH LH	T	Spicer	12 1/4"	Axles Manufactured After July 1994; Double Groove
23 1/8"	E	1 1/2" - 28	1 1/2"	17-782 17-783	RH LH	T	Spicer	12 1/4"	Axles Manufactured After July 1994; Double Groove
23 1/8"	E	1 1/2" - 10	1 5/8"	17-996 17-997	RH LH	T	Spicer	12 1/4"	Axles Manufactured After February 1996; Double Groove
23 1/4"	E	1 1/2" - 28	1 5/8"	17-420 17-421	RH LH	T	Spicer	12 1/4"	Axles Manufactured After February 1996; Double Groove
23 1/4"	C	1 1/2" - 10	1 1/2"	17-690 17-691	RH LH	T	Spicer	12 1/4"	Axles Manufactured Before August 1994; Double Groove
23 1/4"	E	1 1/2" - 10	1 1/2"	17-760 17-761	RH LH	T	Spicer	12 1/4"	Axles Manufactured After July 1994; Double Groove
23 1/4"	E	1 1/2" - 28	1 1/2"	17-778 17-779	RH LH	T	Spicer	12 1/4"	Axles Manufactured After July 1994; Double Groove
23 1/4"	E	1 1/2" - 10	1 5/8"	17-982 17-983	RH LH	T	Spicer	12 1/4"	Axles Manufactured After February 1996; Double Groove
23 5/16"	E	1 1/2" - 28	1 5/8"	17-702 17-703	RH LH	T	Rockwell	12 1/4"	
23 5/16"	E	1 1/2" - 10	1 5/8"	17-716 17-717	RH LH	T	Rockwell	12 1/4"	

*Axle Type: S = Steer, D = Drive, T = Trailer

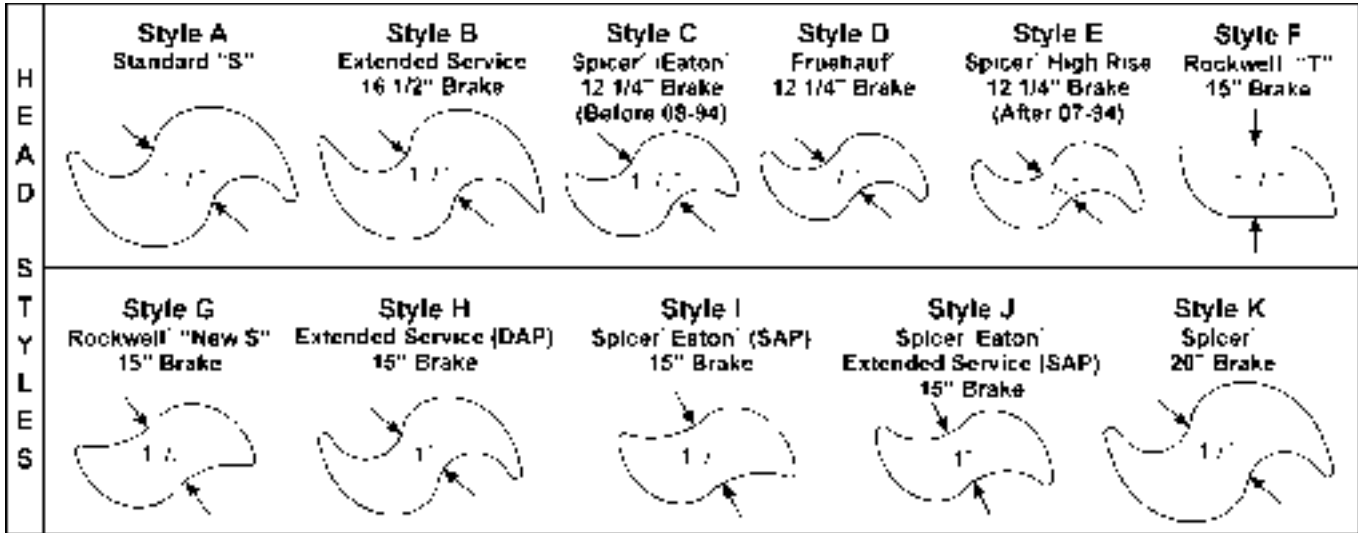

These graphics are for identification purposes only. Dimensions in actual camshafts may vary slightly.

Cam Length	Head Style	Diameter at Splines End & No. of Splines	Diameter at Spider	Spicer Part Number	Side	Axle Type*	Brake Manufacturer	Brake Size	Notes
23 3/8"	E	1 1/2" - 28	1 1/2"	17-11065 17-11066	LH RH	T	Dexter	12 1/4"	
23 7/16"	A	1 1/2" - 10	1 1/2"	17-574 17-575	RH LH	T	Multi-App.	16 1/2"	
23 1/2"	A	1 1/2" - 28	1 1/2"	17-482 17-483	RH LH	T	Spicer	16 1/2"	
23 1/2"	B	1 1/2" - 28	1 1/2"	17-502 17-503	RH LH	T	Spicer	16 1/2"	"XL" Brake
23 1/2"	B	1 1/2" - 10	1 1/2"	17-508 17-509	RH LH	T	Spicer	16 1/2"	"XL" Brake; Double Groove
23 1/2"	C	1 1/2" - 10	1 1/2"	17-710 17-711	RH LH	T	Spicer	12 1/4"	Axles Manufactured Before August 1994; Double Groove
23 1/2"	E	1 1/2" - 10	1 1/2"	17-762 17-763	RH LH	T	Spicer	12 1/4"	Axles Manufactured After July 1994; Double Groove
23 1/2"	B	1 1/2" - 10	1 5/8"	17-862 17-863	RH LH	T	Spicer	16 1/2"	Axles Manufactured After September 1995; "XL" Brake; Double Groove
23 1/2"	B	1 1/2" - 28	1 5/8"	17-928 17-929	RH LH	T	Spicer	16 1/2"	Axles Manufactured After September 1995; "XL" Brake
23 1/2"	E	1 1/2" - 10	1 5/8"	17-984 17-985	RH LH	T	Spicer	12 1/4"	Axles Manufactured After February 1996; Double Groove
23 5/8"	B	1 1/2" - 10	1 5/8"	17-462 17-463	RH LH	T	Eaton	16 1/2"	Extended Service Brake (ES™)
23 5/8"	B	1 1/2" - 28	1 5/8"	17-472 17-473	RH LH	T	Eaton	16 1/2"	Extended Service Brake (ES™)
23 3/4"	A	1 1/2" - 10	1 5/8"	17-636 17-637	RH LH	T	Eaton	16 1/2"	501 Series
23 7/8"	E	1 1/2" - 28	1 5/8"	17-418 17-419	RH LH	T	Spicer	12 1/4"	Axles Manufactured After February 1996; Double Groove
23 7/8"	B	1 1/2" - 28	1 1/2"	17-490 17-491	RH LH	T	Spicer	16 1/2"	"XL" Brake
23 7/8"	A	1 19/32" - 37	1 5/8"	17-616 17-617	RH LH	T	Fruehauf	16 1/2"	"Pro-Par" Type Axle; Air Ride

*Axle Type: S = Steer, D = Drive, T = Trailer

Cam Length	Head Style	Diameter at Spline End & No. of Splines	Diameter at Spider	Spicer Part Number	Side	Axle Type*	Brake Manufacturer	Brake Size	Notes
23 7/8"	C	1 1/2" - 10	1 1/2"	17-694 17-695	RH LH	T	Spicer	12 1/4"	Axles Manufactured Before August 1994; Double Groove
23 7/8"	E	1 1/2" - 10	1 1/2"	17-764 17-765	RH LH	T	Spicer	12 1/4"	Axles Manufactured After July 1994; Double Groove
23 7/8"	E	1 1/2" - 28	1 1/2"	17-798 17-799	RH LH	T	Spicer	12 1/4"	Axles Manufactured After July 1994; Double Groove
23 7/8"	E	1 1/2" - 10	1 5/8"	17-986 17-987	RH LH	T	Spicer	12 1/4"	Axles Manufactured After February 1996; Double Groove
24"	B	1 1/2" - 10	1 1/2"	17-506 17-507	RH LH	T	Spicer	16 1/2"	"XL" Brake; Double Groove
24"	B	1 1/2" - 28	1 1/2"	17-514 17-515	RH LH	T	Spicer	16 1/2"	"XL" Brake
24"	A	1 1/2" - 10	1 1/2"	17-586 17-587	RH LH	T	Multi-App.	16 1/2"	
24"	K	1 3/4" - 10	1 3/4"	17-672 17-673	RH LH	T	Spicer	20"	Severe Duty; Cast Iron Shoe
24"	B	1 1/2" - 10	1 5/8"	17-864 17-865	RH LH	T	Spicer	16 1/2"	Axles Manufactured After September 1995; "XL" Brake; Double Groove
24"	B	1 1/2" - 28	1 5/8"	17-930 17-931	RH LH	T	Spicer	16 1/2"	Axles Manufactured After September 1995; "XL" Brake
24 1/16"	B	1 1/2" - 28	1 5/8"	17-724 17-725	RH LH	T	Rockwell	16 1/2"	"Q Plus" Brake; Forged or Fabricated Spiders; Air Ride
24 1/8"	A	1 1/2" - 28	1 5/8"	17-630 17-631	RH LH	T	Rockwell	16 1/2"	Rockwell 4000-6000 Series; Air Ride; Cast Spider
24 1/8"	A	1 1/2" - 10	1 5/8"	17-642 17-643	RH LH	T	Rockwell	16 1/2"	Rockwell 4000-6000 Series; Air Ride; Cast Spider
24 1/8"	A	1 1/2" - 28	1 5/8"	17-660 17-661	RH LH	T	Rockwell	16 1/2"	Rockwell 4000-6000 Series; Air Ride; Fabricated Spider
24 1/8"	B	1 1/2" - 28	1 5/8"	17-814 17-815	RH LH	T	Rockwell	16 1/2"	Rockwell 4000-6000 Series; "Q Plus" Brake; Air Ride; Cast Spider
24 3/8"	B	1 1/2" - 10	1 1/2"	17-554 17-555	RH LH	T	Spicer	16 1/2"	"XL" Brake; Double Groove
24 3/8"	A	1 1/2" - 10	1 1/2"	17-588 17-589	RH LH	T	Multi-App.	16 1/2"	
24 3/8"	B	1 1/2" - 10	1 5/8"	17-866 17-867	RH LH	T	Spicer	16 1/2"	Axles Manufactured After September 1995; "XL" Brake; Double Groove
24 5/8"	E	1 1/2" - 28	1 1/2"	17-11067 17-11068	LH RH	T	Dexter	12 1/4"	
24 5/8"	C	1 1/2" - 10	1 1/2"	17-648 17-649	RH LH	T	Spicer	12 1/4"	Axles Manufactured Before August 1994; Double Groove
24 5/8"	E	1 1/2" - 10	1 1/2"	17-766 17-767	RH LH	T	Spicer	12 1/4"	Axles Manufactured After July 1994; Double Groove
24 5/8"	E	1 1/2" - 10	1 5/8"	17-988 17-989	RH LH	T	Spicer	12 1/4"	Axles Manufactured After February 1996; Double Groove
24 3/4"	B	1 1/2" - 10	1 1/2"	17-534 17-535	RH LH	T	Spicer	16 1/2"	"XL" Brake; Double Groove
25 1/4"	C	1 1/2" - 10	1 1/2"	17-706 17-707	RH LH	T	Spicer	12 1/4"	Axles Manufactured Before August 1994; Double Groove
25 1/4"	E	1 1/2" - 10	1 1/2"	17-768 17-769	RH LH	T	Spicer	12 1/4"	Axles Manufactured After July 1994; Double Groove

*Axle Type: S = Steer, D = Drive, T = Trailer

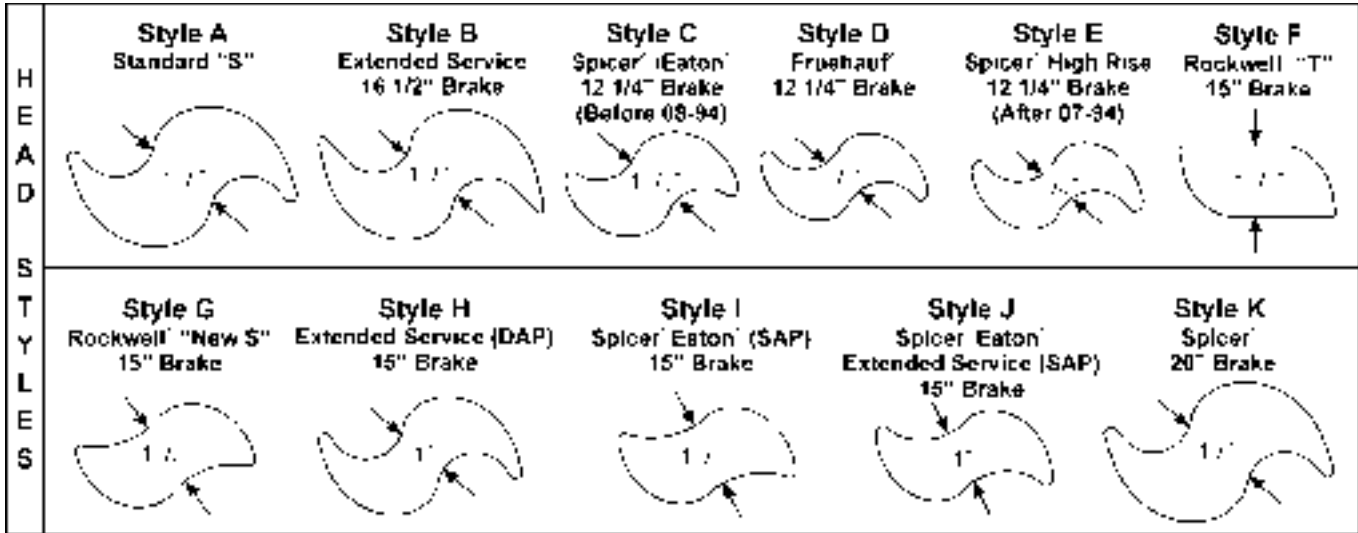

These graphics are for identification purposes only. Dimensions in actual camshafts may vary slightly.

Cam Length	Head Style	Diameter at Spine End & No. of Splines	Diameter at Spider	Spicer Part Number	Side	Axle Type*	Brake Manufacturer	Brake Size	Notes
25 1/4"	E	1 1/2" - 10	1 5/8"	17-990 17-991	RH LH	T	Spicer	12 1/4"	Axles Manufactured After February 1996; Double Groove
25 3/4"	B	1 1/2" - 10	1 1/2"	17-538 17-539	RH LH	T	Spicer	16 1/2"	"XL" Brake; Double Groove
25 3/4"	A	1 1/2" - 10	1 1/2"	17-596 17-597	RH LH	T	Multi-App.	16 1/2"	
25 3/4"	B	1 1/2" - 10	1 5/8"	17-868 17-869	RH LH	T	Spicer	16 1/2"	Axles Manufactured After September 1995; "XL" Brake; Double Groove
26"	B	1 1/2" - 28	1 1/2"	17-492 17-493	RH LH	T	Spicer	16 1/2"	"XL" Brake
26 1/4"	E	1 1/2" - 28	1 5/8"	17-424 17-425	RH LH	T	Spicer	12 1/4"	After Manufactured After February 1996; Double Groove
26 1/4"	B	1 1/2" - 28	1 1/2"	17-526 17-527	RH LH	T	Spicer	16 1/2"	"XL" Brake
26 1/4"	B	1 1/2" - 10	1 1/2"	17-556 17-557	RH LH	T	Spicer	16 1/2"	"XL" Brake; Double Groove
26 1/4"	A	1 1/2" - 10	1 1/2"	17-590 17-591	RH LH	T	Multi-App.	16 1/2"	
26 1/4"	C	1 1/2" - 10	1 1/2"	17-708 17-709	RH LH	T	Spicer	12 1/4"	Axles Manufactured Before August 1994; Double Groove
26 1/4"	E	1 1/2" - 10	1 1/2"	17-770 17-771	RH LH	T	Spicer	12 1/4"	Axles Manufactured After July 1994; Double Groove
26 1/4"	E	1 1/2" - 28	1 1/2"	17-804 17-805	RH LH	T	Spicer	12 1/4"	Axles Manufactured After July 1994; Double Groove
26 1/4"	B	1 1/2" - 10	1 5/8"	17-870 17-871	RH LH	T	Spicer	16 1/2"	Axles Manufactured After September 1995; "XL" Brake; Double Groove
26 1/4"	B	1 1/2" - 28	1 5/8"	17-936 17-937	RH LH	T	Spicer	16 1/2"	Axles Manufactured After September 1995; "XL" Brake
26 1/4"	E	1 1/2" - 10	1 5/8"	17-992 17-993	RH LH	T	Spicer	12 1/4"	Axles Manufactured After February 1996; Double Groove
26 1/2"	E	1 1/2" - 28	1 1/2"	17-11069 17-11070	LH RH	T	Dexter	12 1/4"	

*Axle Type: S = Steer, D = Drive, T = Trailer

Cam Length	Head Style	Diameter at Spline End & No. of Splines	Diameter at Spider	Spicer Part Number	Side	Axle Type*	Brake Manufacturer	Brake Size	Notes
26 1/2"	B	1 1/2" - 10	1 1/2"	17-558 17-559	RH LH	T	Spicer	16 1/2"	"XL" Brake; Double Groove
26 1/2"	A	1 1/2" - 10	1 1/2"	17-592 17-593	RH LH	T	Multi-App.	16 1/2"	
26 1/2"	C	1 1/2" - 10	1 1/2"	17-696 17-697	RH LH	T	Spicer	12 1/4"	Axles Manufactured Before August 1994; Double Groove
26 1/2"	E	1 1/2" - 10	1 1/2"	17-772 17-773	RH LH	T	Spicer	12 1/4"	Axles Manufactured After July 1994; Double Groove
26 1/2"	B	1 1/2" - 10	1 5/8"	17-872 17-873	RH LH	T	Spicer	16 1/2"	Axles Manufactured After September 1995; "XL" Brake; Double Groove
26 1/2"	E	1 1/2" - 10	1 5/8"	17-994 17-995	RH LH	T	Spicer	12 1/4"	Axles Manufactured After February 1996; Double Groove
26 7/8"	B	1 1/2" - 28	1 1/2"	17-522 17-523	RH LH	T	Spicer	16 1/2"	"XL" Brake
26 7/8"	B	1 1/2" - 28	1 5/8"	17-940 17-941	RH LH	T	Spicer	16 1/2"	Axles Manufactured After September 1995; "XL" Brake
30 1/4"	B	1 1/2" - 28	1 1/2"	17-528 17-529	RH LH	T	Spicer	16 1/2"	"XL" Brake
30 1/4"	B	1 1/2" - 10	1 1/2"	17-564 17-565	RH LH	T	Spicer	16 1/2"	"XL" Brake; Double Groove
30 1/4"	B	1 1/2" - 10	1 5/8"	17-880 17-881	RH LH	T	Spicer	16 1/2"	Axles Manufactured After September 1995; "XL" Brake; Double Groove
30 1/4"	B	1 1/2" - 28	1 5/8"	17-946 17-947	RH LH	T	Spicer	16 1/2"	Axles Manufactured After September 1995; "XL" Brake

*Axle Type: S = Steer, D = Drive, T = Trailer

Bendix 15" x 4" Brake

"Brazilian" Brake

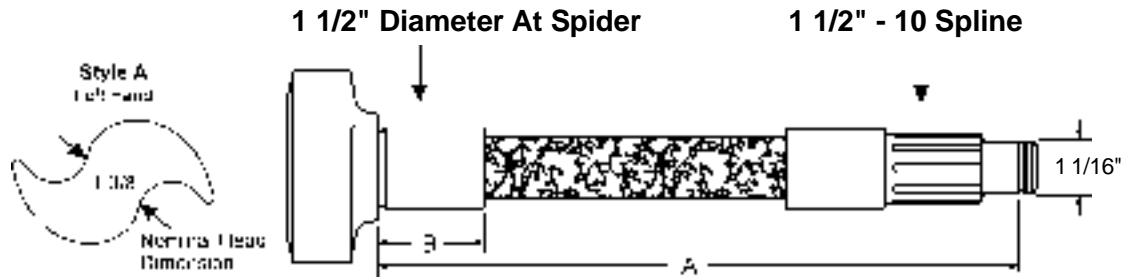

General Information:

- All Cam Lengths ("A" Dim.) Are Measured From Under Cam Head to Beginning of Lock Ring Groove.
- Use Camshaft Repair Kit: 43-7064

Spicer No.	Replaces	A Dim.	B Dim.	Application
18-704 RH	Bendix 2259444	8 3/16"	1 3/4"	Ford Cargo
18-705 LH	Bendix 2259443			

Eaton 15" Brake

Single Anchor Pin (SAP) Brake

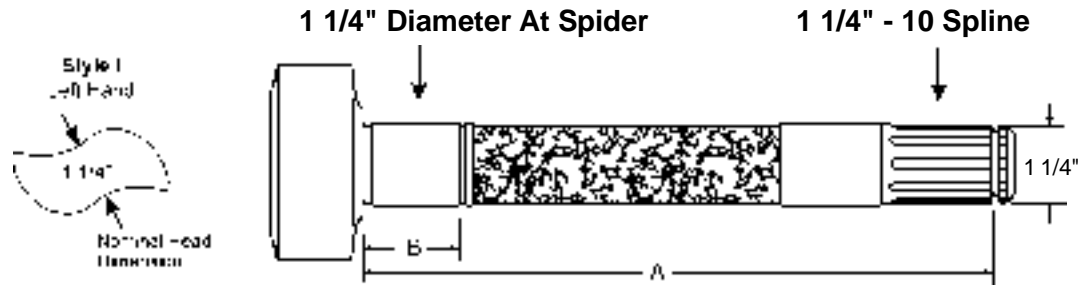

General Information:

- All Cam Lengths ("A" Dim.) Are Measured From Under Cam Head to Beginning of Lock Ring Groove.
- Use Camshaft Repair Kit: 43-7060

Spicer No.	Replaces	A Dim.	B Dim.	Application
18-760 RH	Eaton 1006725 Euclid E-5059 Meritor / Rockwell R607128	7 5/8"	1 7/8"	GMC
18-761 LH	Eaton 1006724 Euclid E-5058 Meritor / Rockwell R607127			
18-762 RH	Eaton 1006727 Eaton Top Spec 7-3703 Euclid E-5130 Meritor / Rockwell R607130	7 15/16"	1 7/8"	Ford
18-763 LH	Eaton 1006726 Eaton Top Spec 7-3702 Euclid E-5129 Meritor / Rockwell R607129			
18-764 RH	Eaton 1006949 Euclid E-5065 Meritor / Rockwell R607142	8 11/64"	1 7/8"	Mack
18-765 LH	Eaton 1006948 Euclid E-5064 Meritor / Rockwell R607141			
18-766 RH	Eaton 1006731 Euclid E-5061 Meritor / Rockwell R607134	8 9/16"	1 7/8"	Freightliner
18-767 LH	Eaton 1006730 Euclid E-5060 Meritor / Rockwell R607133			
18-768 RH	Eaton 1008007 Euclid E-5067 Meritor / Rockwell R607144	8 15/16"	1 7/8"	Navistar
18-769 LH	Eaton 1008006 Euclid E-5066 Meritor / Rockwell R607143			

Continued Next Page

Eaton 15" Brake (Continued)

Single Anchor Pin (SAP) Brake

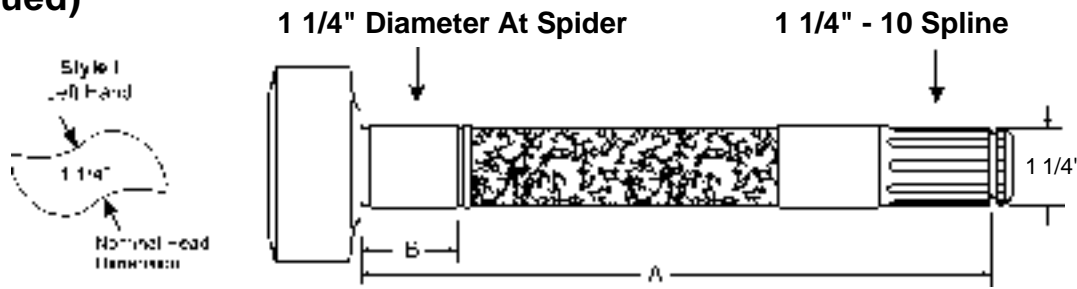

General Information:

- All Cam Lengths ("A" Dim.) Are Measured From Under Cam Head to Beginning of Lock Ring Groove.
- Use Camshaft Repair Kit: 43-7060

Spicer No.	Replaces	A Dim.	B Dim.	Application
18-770 RH	Eaton 1006867 Eaton Top Spec 7-3707 Euclid E-5132 Meritor / Rockwell R607138	9 3/16"	1 7/8"	Kenworth
18-771 LH	Eaton 1006866 Eaton Top Spec 7-3706 Euclid E-5131 Meritor / Rockwell R607137			
18-772 RH	Eaton 1006729 Eaton Top Spec 7-3705 Euclid E-5134 Meritor / Rockwell R607132	9 9/16"	1 7/8"	Navistar
18-773 LH	Eaton 1006728 Eaton Top Spec 7-3704 Euclid E-5133 Meritor / Rockwell R607131			
18-774 RH	Eaton 1006941 Eaton Top Spec 7-3709 Euclid E-5136 Meritor / Rockwell R607140	9 25/32"	1 7/8"	Mack
18-775 LH	Eaton 1006940 Eaton Top Spec 7-3708 Euclid E-5135 Meritor / Rockwell R607139			
18-776 RH	Eaton 1006865 Euclid E-5063 Meritor / Rockwell R607136	10 29/32"	1 7/8"	Kenworth, Peterbilt
18-777 LH	Eaton 1006864 Euclid E-5062 Meritor / Rockwell R607135			
18-778 RH	Eaton 1008247 Euclid E-5069 Meritor / Rockwell R607146	11 1/8"	1 7/8"	GMC
18-779 LH	Eaton 1008246 Euclid E-5068 Meritor / Rockwell R607145			

Eaton 15" x 4" Brake

Extended Service (ES™) Brake

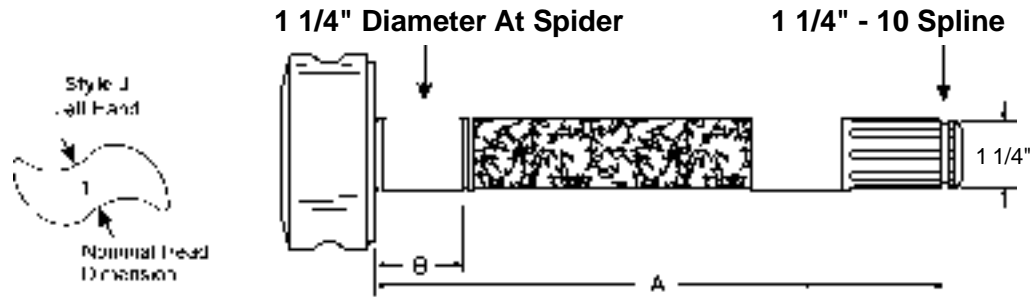

General Information:

- All Cam Lengths ("A" Dim.) Are Measured From Under Cam Head to Beginning of Lock Ring Groove.
- Use Camshaft Repair Kit: 43-7060

Spicer No.	Replaces	A Dim.	B Dim.
18-960 RH	Eaton 813493	7 5/8"	1 7/8"
18-961 LH	Eaton 813492		
18-962 RH	Eaton 813487 Euclid E-9029 Meritor / Rockwell R607122	7 15/16"	1 7/8"
18-963 LH	Eaton 813486 Euclid E-9028 Meritor / Rockwell R607121		
18-964 RH	Eaton 813479	8 3/16"	1 7/8"
18-965 LH	Eaton 813478		
18-966 RH	Eaton 813491	8 3/8"	1 7/8"
18-967 LH	Eaton 813490		
18-968 RH	Eaton 813489	8 9/16"	1 7/8"
18-969 LH	Eaton 813488		
18-970 RH	Eaton 813497	8 15/16"	1 7/8"
18-971 LH	Eaton 813496		
18-972 RH	Eaton 813481 Euclid E-9031 Meritor / Rockwell R607118	9 3/16"	1 7/8"
18-973 LH	Eaton 813480 Euclid E-9030 Meritor / Rockwell R607117		
18-974 RH	Eaton 813483 Euclid E-9033 Meritor / Rockwell R607120	9 9/16"	1 7/8"
18-975 LH	Eaton 813482 Euclid E-9032 Meritor / Rockwell R607119		
18-976 RH	Eaton 813495 Euclid E-9035	9 7/8"	1 7/8"
18-977 LH	Eaton 813494 Euclid E-9034		

Continued Next Page

Eaton 15" x 4" Brake (Continued)

Extended Service (ES™) Brake

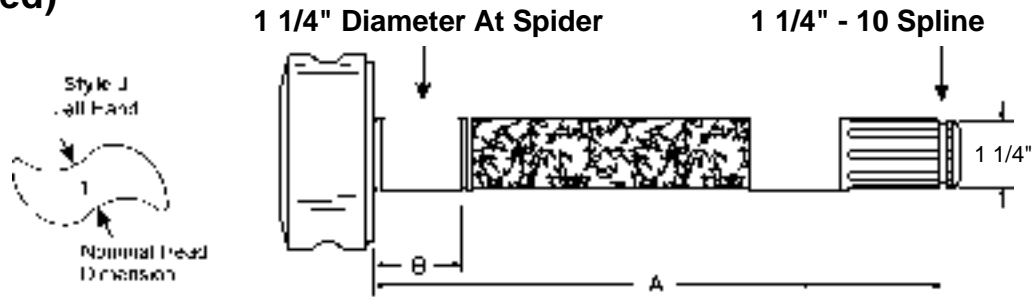

General Information:

- All Cam Lengths ("A" Dim.) Are Measured From Under Cam Head to Beginning of Lock Ring Groove.
- Use Camshaft Repair Kit: 43-7060

Spicer No.	Replaces	A Dim.	B Dim.
18-978 RH	Eaton 813485 Meritor / Rockwell R607124	10 29/32"	1 7/8"
18-979 LH	Eaton 813484 Meritor / Rockwell R607123		
18-980 RH	Eaton 813499	11 1/8"	1 7/8"
18-981 LH	Eaton 813498		

Rockwell 14 1/2" Brake

"W" Brake

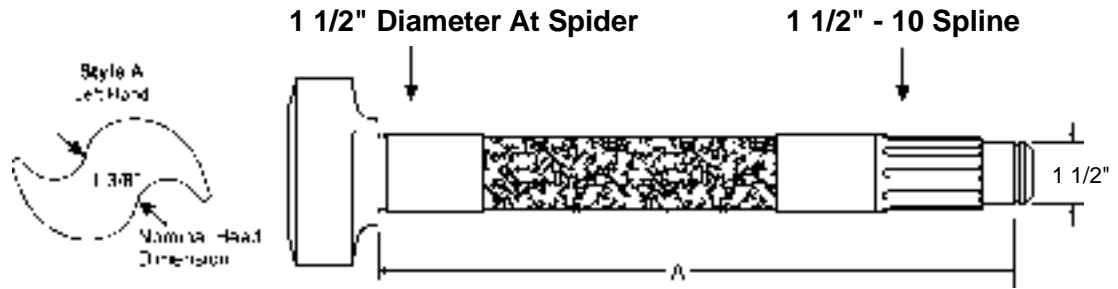

General Information:

· All Cam Lengths ("A" Dim.) Are Measured From Under Cam Head to Beginning of Lock Ring Groove.

Spicer No.	Replaces	A Dim.
18-992 RH	Euclid E-10896	5 13/64"
18-993 LH	Euclid E-10895	
18-990 RH	Euclid E-10864	5 3/8"
18-991 LH	Euclid E-10863	

Rockwell "Q" 15" x 4" Brake

1 1/2" Offset Backing Plate

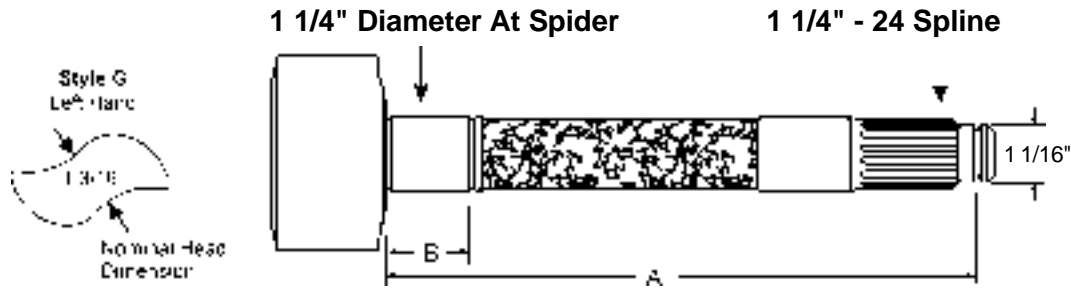

General Information:

- All Cam Lengths ("A" Dim.) Are Measured From Under Cam Head to Beginning of Lock Ring Groove.
- Use Camshaft Repair Kit: 43-7059

Spicer No.	Replaces	A Dim.	B Dim.
18-890 RH	Meritor / Rockwell 2210-G-6481 Meritor / Rockwell 2210-T-6728 Euclid E-9706	7 15/16"	1 13/16"
18-891 LH	Meritor / Rockwell 2210-F-6480 Meritor / Rockwell 2210-S-6727 Euclid E-9705		
18-892 RH	Meritor / Rockwell 2210-K-6615 Meritor / Rockwell 2210-X-6732 Euclid E-9708	8 15/32"	1 13/16"
18-893 LH	Meritor / Rockwell 2210-J-6614 Meritor / Rockwell 2210-W-6731 Euclid E-9707		
18-894 RH	Meritor / Rockwell 2210-T-6572 Meritor / Rockwell 2210-Z-6734	8 17/32"	1 13/16"
18-895 LH	Meritor / Rockwell 2210-S-6571 Meritor / Rockwell 2210-T-6733		
18-896 RH	Meritor / Rockwell 2210-D-6738 Meritor / Rockwell 2210-E-6531 Euclid E-5530	9 1/4"	1 13/16"
18-897 LH	Meritor / Rockwell 2210-C-6737 Meritor / Rockwell 2210-D-6530 Euclid E-5529		
18-898 RH	Meritor / Rockwell 2210-H-6612 Meritor / Rockwell 2210-K-6745	9 15/32"	1 13/16"
18-899 LH	Meritor / Rockwell 2210-G-6611 Meritor / Rockwell 2210-J-6744		
18-900 RH	Meritor / Rockwell 2210-M-6747 Meritor / Rockwell 2210-R-6518 Euclid E-9712	9 17/32"	1 13/16"
18-901 LH	Meritor / Rockwell 2210-L-6746 Meritor / Rockwell 2210-Q-6517 Euclid E-9711		

NOTE: "Q Plus" cams can be used to replace the standard "Q" cams. However, a "Q" cam cannot be used to replace a "Q Plus" cam.

Rockwell "Q" 15" x 4" Brake

2" Offset Backing Plate

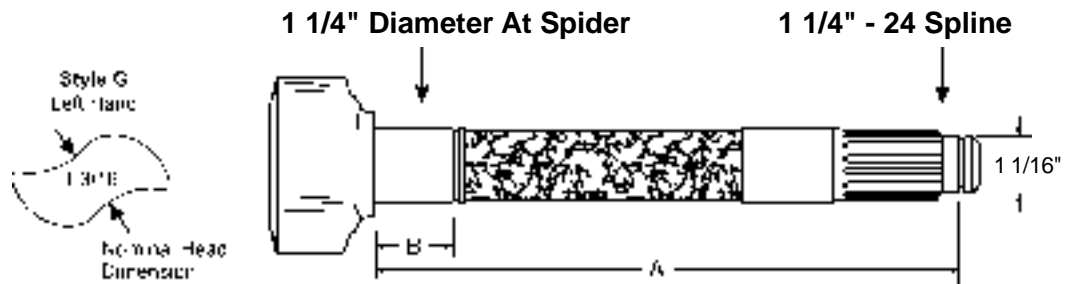

General Information:

- All Cam Lengths ("A" Dim.) Are Measured From Under Cam Head to Beginning of Lock Ring Groove.
- Use Camshaft Repair Kit: 43-7059

Spicer No.	Replaces	A Dim.	B Dim.
18-902 RH	Meritor / Rockwell 2210-C-6503 Meritor / Rockwell 2210-P-6724	7 1/8"	1 13/16"
18-903 LH	Meritor / Rockwell 2210-B-6502 Meritor / Rockwell 2210-N-6722		
18-904 RH	Meritor / Rockwell 2210-J-6484 Meritor / Rockwell 2210-R-6726 Euclid E-9714	7 23/32"	1 13/16"
18-905 LH	Meritor / Rockwell 2210-H-6482 Meritor / Rockwell 2210-Q-6725 Euclid E-9713	9 5/16"	1 13/16"
18-906 RH	Meritor / Rockwell 2210-F-6740 Meritor / Rockwell 2210-S-6493 Euclid E-9716		
18-907 LH	Meritor / Rockwell 2210-E-6739 Meritor / Rockwell 2210-R-6492 Euclid E-9715		
18-908 RH	Meritor / Rockwell 2210-Q-6543 Meritor / Rockwell 2210-R-6752 Euclid E-9718	9 15/16"	1 13/16"
18-909 LH	Meritor / Rockwell 2210-P-6542 Meritor / Rockwell 2210-Q-6751 Euclid E-9717		

NOTE: "Q Plus" cams can be used to replace the standard "Q" cams. However, a "Q" cam cannot be used to replace a "Q Plus" cam.

Rockwell 15" "T" Series Brake

New Style S-head Cam

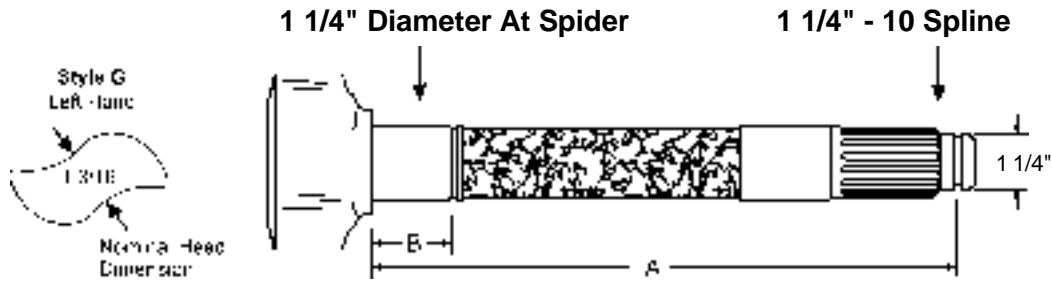

General Information:

- All Cam Lengths ("A" Dim.) Are Measured From Under Cam Head to Beginning of Lock Ring Groove.
- Use Camshaft Repair Kit: 43-7051

Spicer No.	Replaces	A Dim.	B Dim.
18-954 RH	Meritor / Rockwell 2210-E-6843 Euclid E-9694	7 21/32"	1 13/16"
18-955 LH	Meritor / Rockwell 2210-D-6842 Euclid E-9693		
18-950 RH	Meritor / Rockwell 2210-G-6845 Euclid E-9696	7 15/16"	1 13/16"
18-951 LH	Meritor / Rockwell 2210-F-6844 Euclid E-9695		
18-952 RH	Meritor / Rockwell 2210-N-6852 Euclid E-9698	8 1/2"	1 13/16"
18-953 LH	Meritor / Rockwell 2210-M-6851 Euclid E-9697		
18-956 RH	Meritor / Rockwell 2210-S-6857 Euclid E-9700	9 1/4"	1 13/16"
18-957 LH	Meritor / Rockwell 2210-R-6856 Euclid E-9699		
18-958 RH	Meritor / Rockwell 2210-W-6861 Euclid E-9702	9 17/32"	1 13/16"
18-959 LH	Meritor / Rockwell 2210-V-6860 Euclid E-9701		
18-948 RH	Meritor / Rockwell 2210-Y-6863 Euclid E-9704	9 13/16"	1 13/16"
18-949 LH	Meritor / Rockwell 2210-X-6862 Euclid E-9703		

Rockwell 15" "T" Series Brake

Standard T-Head Cam

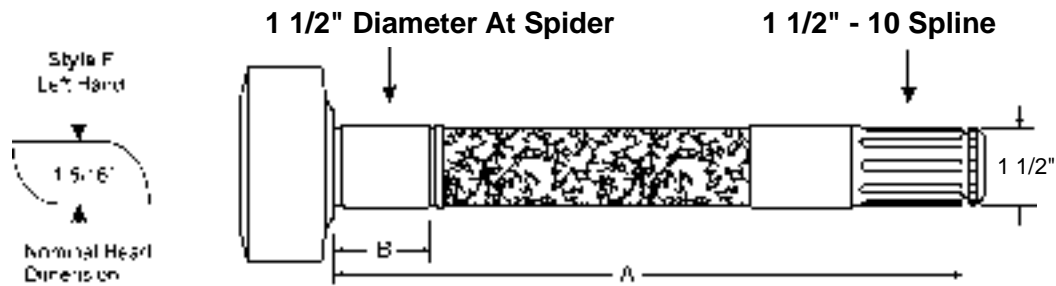

General Information:

- All Cam Lengths ("A" Dim.) Are Measured From Under Cam Head to Beginning of Lock Ring Groove.
- Use Camshaft Repair Kit: 43-7050

Spicer No.	Replaces	A Dim.	B Dim.
18-840 RH	Meritor / Rockwell 2210-P-2798 Meritor / Rockwell 2210-X-2910 Meritor / Rockwell 2210-Z-5408	5 25/32"	1 13/16"
18-841 LH	Meritor / Rockwell 2210-Q-2799 Meritor / Rockwell 2210-Y-2911 Meritor / Rockwell 2210-Y-5407		
18-842 RH	Meritor / Rockwell 2210-V-2804 Meritor / Rockwell 2210-X-5406 Euclid E-1089	7 9/16"	1 13/16"
18-843 LH	Meritor / Rockwell 2210-W-2805 Meritor / Rockwell 2210-W-5405 Euclid E-1090		
18-844 RH	Meritor / Rockwell 2210-B-5748 Meritor / Rockwell 2210-C-4683 Euclid E-4941	8 1/32"	1 13/16"
18-845 LH	Meritor / Rockwell 2210-A-5747 Meritor / Rockwell 2210-B-4682 Euclid E-4940		
18-846 RH	Meritor / Rockwell 2210-B-5410	8 7/32"	1 13/16"
18-847 LH	Meritor / Rockwell 2210-A-5409		
18-848 RH	Meritor / Rockwell 2210-A-4837 Meritor / Rockwell 2210-Z-5668 Euclid E-4992	8 1/2"	1 13/16"
18-849 LH	Meritor / Rockwell 2210-Y-5667 Meritor / Rockwell 2210-Z-4836 Euclid E-4991		
18-882 RH	Meritor / Rockwell 2210-H-5728 Meritor / Rockwell 2210-V-3402 Euclid E-4994	8 21/32"	1 13/16"
18-883 LH	Meritor / Rockwell 2210-G-5727 Meritor / Rockwell 2210-U-3401 Euclid E-4993		

Continued Next Page

Rockwell 15" "T" Series Brake (Continued)

Standard T-Head Cam

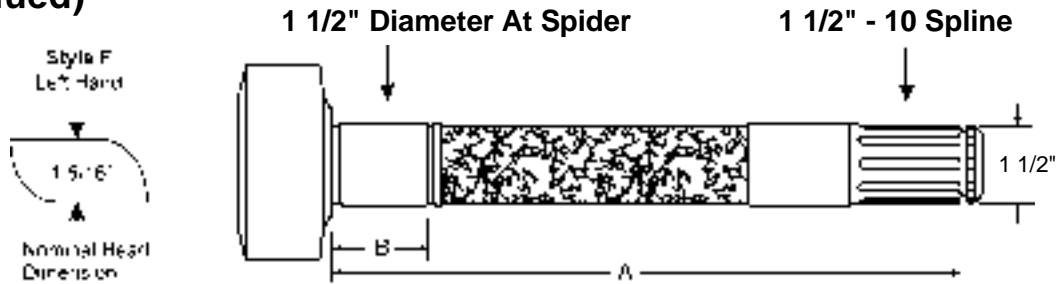

General Information:

- All Cam Lengths ("A" Dim.) Are Measured From Under Cam Head to Beginning of Lock Ring Groove.
- Use Camshaft Repair Kit: 43-7050

Spicer No.	Replaces	A Dim.	B Dim.
18-880 RH	Meritor / Rockwell 2210-F-5804 Meritor / Rockwell 2210-X-3404 Euclid E-4996	8 7/8"	1 13/16"
18-881 LH	Meritor / Rockwell 2210-E-5803 Meritor / Rockwell 2210-W-3403 Euclid E-4995		
18-884 RH	Meritor / Rockwell 2210-T-3400 Meritor / Rockwell 2210-X-5666 Euclid E-4998	9 1/8"	1 13/16"
18-885 LH	Meritor / Rockwell 2210-S-3399 Meritor / Rockwell 2210-W-5665 Euclid E-4997		
18-886 RH	Meritor / Rockwell 2210-G-4791	11 3/4"	1 13/16"
18-887 LH	Meritor / Rockwell 2210-F-4790		

Rockwell 15" "T" Series Brake

Standard T-Head Cam

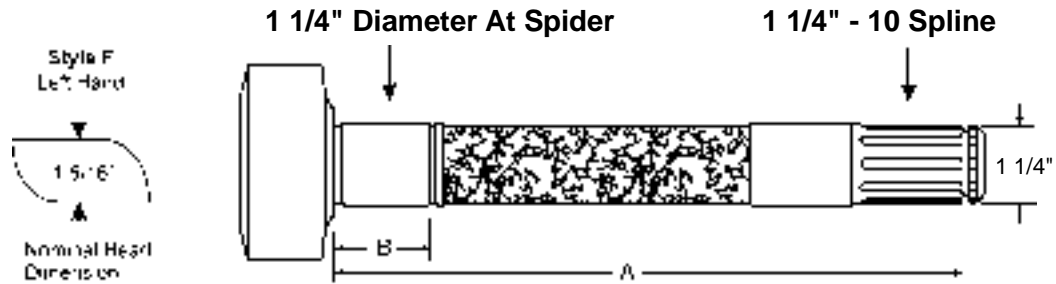

General Information:

- All Cam Lengths ("A" Dim.) Are Measured From Under Cam Head to Beginning of Lock Ring Groove.
- Use Camshaft Repair Kit: 43-7051

Spicer No.	Replaces	A Dim.	B Dim.
18-1129 LH	Meritor / Rockwell 2210-Q-5399 Euclid E-4912	7 21/32"	1 13/16"
18-1130 RH	Meritor / Rockwell 2210-R-5400 Euclid E-4913		
18-856 RH	Meritor / Rockwell 2210-R-5556 Meritor / Rockwell 2210-T-5974 Meritor / Rockwell 2210-Z-4992 Euclid E-3461	7 15/16"	1 13/16"
18-857 LH	Meritor / Rockwell 2210-Q-5555 Meritor / Rockwell 2210-S-5973 Meritor / Rockwell 2210-Y-4991 Euclid E-3460		
18-858 RH	Meritor / Rockwell 2210-B-5020 Meritor / Rockwell 2210-V-5612 Meritor / Rockwell 2210-Y-5953 Euclid E-4917	8 1/2"	1 13/16"
18-859 LH	Meritor / Rockwell 2210-A-5019 Meritor / Rockwell 2210-U-5611 Meritor / Rockwell 2210-X-5952 Euclid E-4916		
18-872 RH	Meritor / Rockwell 2210-D-5620 Meritor / Rockwell 2210-R-5062 Euclid E-4919	9 1/4"	1 13/16"
18-873 LH	Meritor / Rockwell 2210-C-5619 Meritor / Rockwell 2210-Q-5061 Euclid E-4918		
18-874 RH	Meritor / Rockwell 2210-F-5258 Meritor / Rockwell 2210-F-5674 Euclid E-4937	9 17/32"	1 13/16"
18-875 LH	Meritor / Rockwell 2210-E-5257 Meritor / Rockwell 2210-E-5673 Euclid E-4936		

Continued Next Page

Rockwell 15" "T" Series Brake (Continued)

Standard T-Head Cam

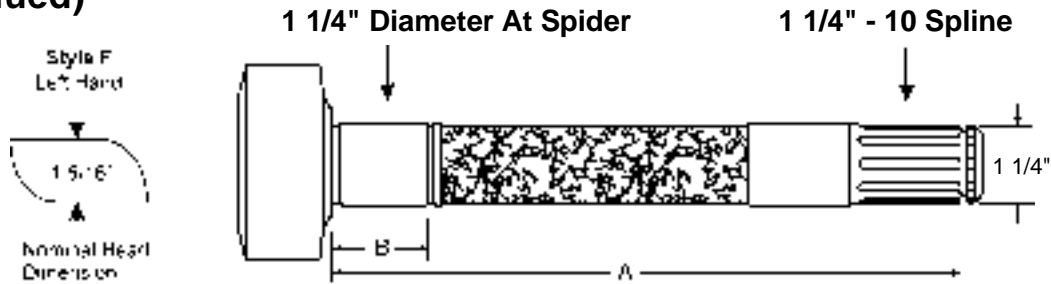

General Information:

- All Cam Lengths ("A" Dim.) Are Measured From Under Cam Head to Beginning of Lock Ring Groove.
- Use Camshaft Repair Kit: 43-7051

Spicer No.	Replaces	A Dim.	B Dim.
18-876 RH	Meritor / Rockwell 2210-R-4984 Meritor / Rockwell 2210-R-5608 Meritor / Rockwell 2210-Y-6863 Euclid E-4907	9 13/16"	1 13/16"
18-877 LH	Meritor / Rockwell 2210-Q-4983 Meritor / Rockwell 2210-Q-5607 Meritor / Rockwell 2210-X-6862 Euclid E-4906		

Rockwell 15" x 4" Brake

"Q Plus" Brake

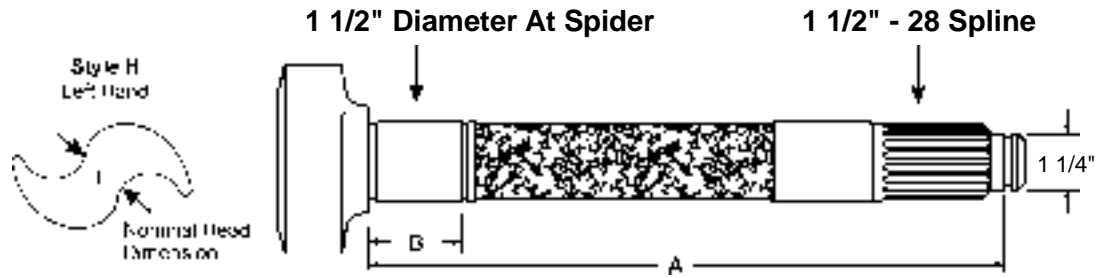

General Information:

- All Cam Lengths ("A" Dim.) Are Measured From Under Cam Head to Beginning of Lock Ring Groove.
- Use Camshaft Repair Kit: 43-7070

Spicer No.	Replaces	A Dim.	B Dim.
18-936 RH	Meritor / Rockwell 2210-H-6976 Meritor / Rockwell 2210-M-7449 Euclid E-9066	9 5/16"	2"
18-937 LH	Meritor / Rockwell 2210-J-6978 Meritor / Rockwell 2210-N-7450 Euclid E-9065		
18-938 RH	Meritor / Rockwell 2210-R-7454 Euclid E-9068	9 7/16"	2"
18-939 LH	Meritor / Rockwell 2210-S-7455 Euclid E-9067		

NOTE: "Q Plus" cams can be used to replace the standard "Q" cams. However, a "Q" cam cannot be used to replace a "Q Plus" cam.

Spicer 15" x 4" Brake

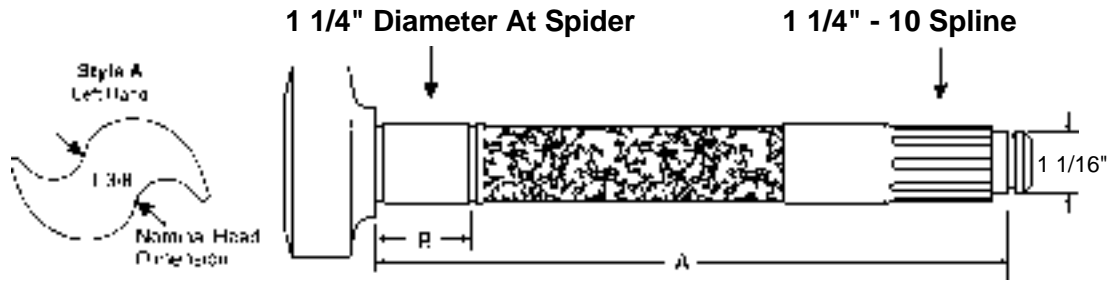

General Information:

- All Cam Lengths ("A" Dim.) Are Measured From Under Cam Head to Beginning of Lock Ring Groove.
- Use Camshaft Repair Kit: 43-7080

Spicer No.	Replaces	A Dim.	B Dim.
18-620 RH	Spicer OE 150WK103-1	7 15/16"	1 7/8"
18-621 LH	Spicer OE 150WK102-1		
18-622 RH	Spicer OE 150WK103-5	8 1/8"	1 7/8"
18-623 LH	Spicer OE 150WK102-5		
18-624 RH	Spicer OE 150WK103-4	8 5/8"	1 7/8"
18-625 LH	Spicer OE 150WK102-4		
18-626 RH	Spicer OE 150WK103-6	8 3/4"	1 7/8"
18-627 LH	Spicer OE 150WK102-6		
18-628 RH	Spicer OE 150WK103-3	9 1/4"	1 7/8"
18-629 LH	Spicer OE 150WK102-3		
18-630 RH	Spicer OE 150WK103-2	9 1/2"	1 7/8"
18-631 LH	Spicer OE 150WK102-2		
18-634 RH	Spicer OE 150WK103-7	10 11/16"	1 7/8"
18-635 LH	Spicer OE 150WK102-7		

Wagner 15" Brake

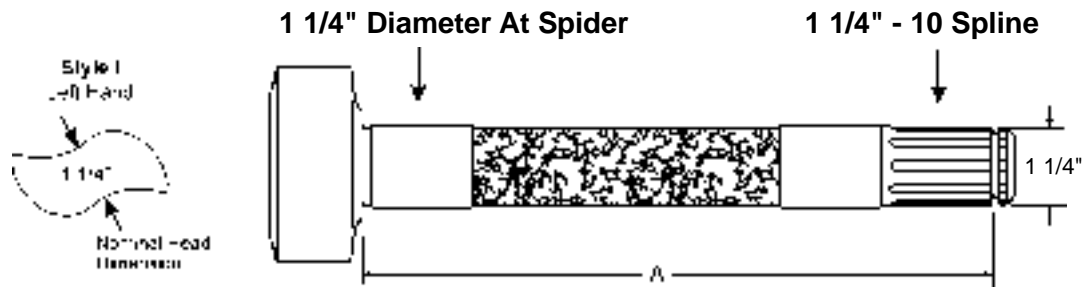

General Information:

- All Cam Lengths ("A" Dim.) Are Measured From Under Cam Head to Beginning of Lock Ring Groove.
- Use Camshaft Repair Kit: 43-7053A

Spicer No.	Replaces	A Dim.
18-910 RH	Wagner F89681	5 23/32"
18-911 LH	Wagner F89680	

Bendix 16 1/2" Brake

"Brazilian" Brake

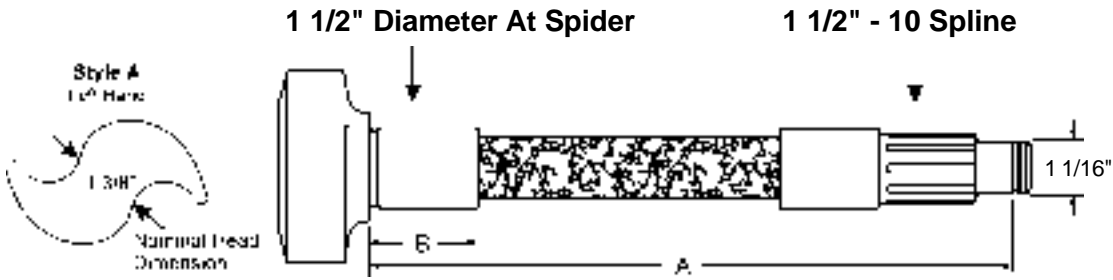

General Information:

- All Cam Lengths ("A" Dim.) Are Measured From Under Cam Head to Beginning of Lock Ring Groove.
- Use Camshaft Repair Kit: 43-7065

Spicer No.	Replaces	A Dim.	B Dim.	Application
18-708 RH	Bendix 2259397	12 1/8"	1 3/4"	Ford Cargo
18-709 LH	Bendix 2259398			

Eaton 16 1/2" Brake

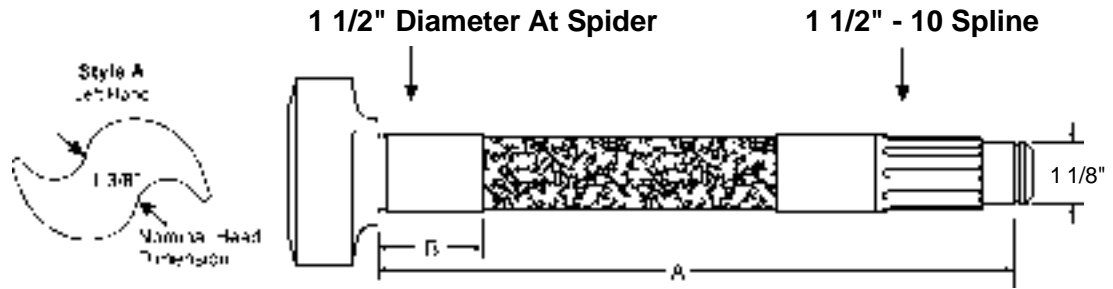

General Information:

- All Cam Lengths ("A" Dim.) Are Measured From Under Cam Head to Beginning of Lock Ring Groove.
- Use Camshaft Repair Kit: 43-7041

Spicer No.	Replaces	A Dim.	B Dim.	Application
18-726 RH	Eaton 1000088 Eaton Top Spec 7-2390 Euclid E-2799 Meritor / Rockwell R607035	8 9/16"	1 9/16"	Mack
18-727 LH	Eaton 1000087 Eaton Top Spec 7-2389 Euclid E-2800 Meritor / Rockwell R607036			
18-728 RH	Eaton 89118	8 15/16"	1 9/16"	GMC, Navistar
18-729 LH	Eaton 89117			
18-730 RH	Eaton 808793	9 13/16"	1 9/16"	GMC, Ford
18-731 LH	Eaton 808792			
18-732 RH	Eaton 40458 Euclid E-9764 Meritor / Rockwell R607148	10 3/16"	1 9/16"	
18-733 LH	Eaton 40547 Euclid E-9763 Meritor / Rockwell R607147			
18-734 RH	Eaton Top Spec 7-3696 Eaton 70309 Euclid E-4887 Meritor / Rockwell R607262	10 1/2"	1 9/16"	
18-735 LH	Eaton Top Spec 7-3697 Eaton 70308 Euclid E-4886 Meritor / Rockwell R607261			
18-736 RH	Eaton Top Spec 7-3699 Eaton 76294 Euclid E-9766 Meritor / Rockwell R607150	11 1/8"	1 9/16"	
18-737 LH	Eaton Top Spec 7-3698 Eaton 76293 Euclid E-9765 Meritor / Rockwell R607149			

Continued Next Page

Eaton 16 1/2" Brake

(Continued)

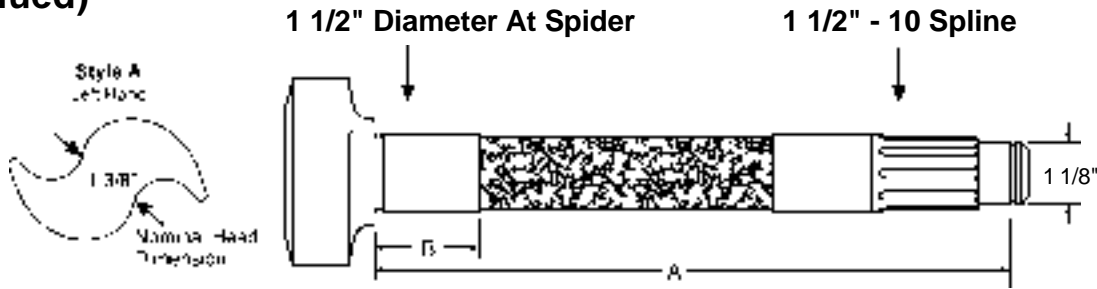

General Information:

- All Cam Lengths ("A" Dim.) Are Measured From Under Cam Head to Beginning of Lock Ring Groove.
- Use Camshaft Repair Kit: 43-7041

Spicer No.	Replaces	A Dim.	B Dim.	Application
18-738 RH	Eaton Top Spec 7-2395 Eaton 70307 Euclid E-1775 Meritor / Rockwell R607015	11 1/2"	1 9/16"	Freightliner, Navistar, Peterbilt
18-739 LH	Eaton Top Spec 7-2396 Eaton 70306 Euclid E-1776 Meritor / Rockwell R607016			
18-740 RH	Eaton Top Spec 7-2399 Eaton 71307 Euclid E-2786 Meritor / Rockwell R607029	12 7/16"	1 9/16"	GMC, Navistar, Ford, Mack, Paccar
18-741 LH	Eaton Top Spec 7-2400 Eaton 71306 Euclid E-2787 Meritor / Rockwell R607030			
18-748 RH	Eaton 1000840 Eaton Top Spec 7-3701 Euclid E-4889 Meritor / Rockwell R607126	13"	1 9/16"	
18-749 LH	Eaton 1000839 Eaton Top Spec 7-3700 Euclid E-4888 Meritor / Rockwell R607125			
18-742 RH	Eaton 35456 Eaton Top Spec 7-3695 Euclid E-4741 Meritor / Rockwell R607050	13 7/16"	1 9/16"	Navistar, Mack
18-743 LH	Eaton 35455 Eaton Top Spec 7-3694 Euclid E-4740 Meritor / Rockwell R607049			

Continued Next Page

Eaton 16 1/2" Brake

(Continued)

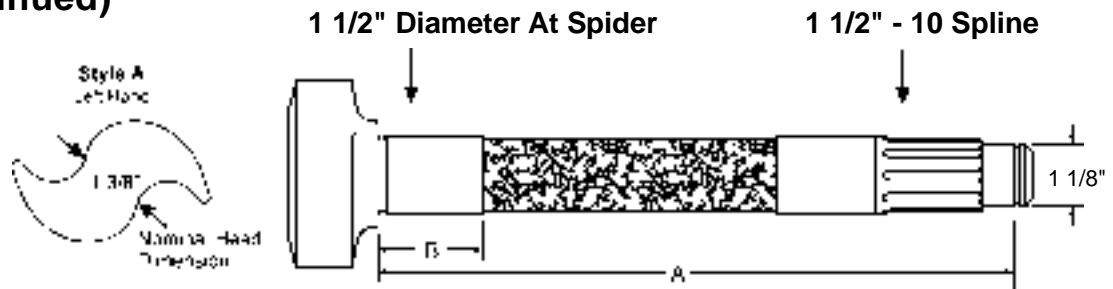

General Information:

- All Cam Lengths ("A" Dim.) Are Measured From Under Cam Head to Beginning of Lock Ring Groove.
- Use Camshaft Repair Kit: 43-7041

Spicer No.	Replaces	A Dim.	B Dim.	Application
18-746 RH	Eaton 1001581 Euclid E-3524 Meritor / Rockwell R607037	14 1/4"	1 9/16"	
18-747 LH	Eaton 1001580 Euclid E-3523 Meritor / Rockwell R607038			
18-754 RH	Eaton 807141	14 9/16"	1 9/16"	
18-755 LH	Eaton 807140			
18-744 RH	Eaton 35431 Eaton Top Spec 7-3693 Euclid E-9056 Meritor / Rockwell R607104	15"	1 9/16"	Peterbilt
18-745 LH	Eaton 35430 Eaton Top Spec 7-3692 Euclid E-9055 Meritor / Rockwell R607103			
18-750 RH	Eaton 1001723	15 7/8"	1 9/16"	Freightliner, Navistar, Peterbilt
18-751 LH	Eaton 1001722			
18-752 RH	Eaton 89164	19 1/2"	1 9/16"	Air Lift Tag Axle
18-753 LH	Eaton 89163			

Eaton 16 1/2" Brake

Extended Service (ES™) Brake

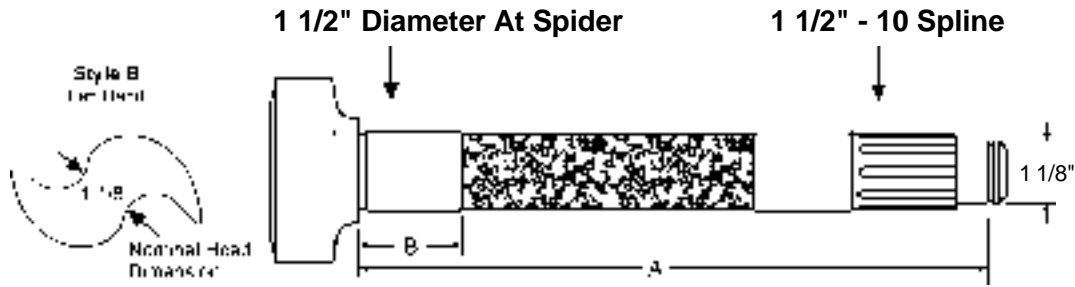

General Information:

- All Cam Lengths ("A" Dim.) Are Measured From Under Cam Head to Beginning of Lock Ring Groove.
- Use Camshaft Repair Kit:
 43-7068 (Severe Service Bronze Spider Bushing)
 43-7069 (All Nylon Bushings)

Spicer No.	Replaces	A Dim.	B Dim.
18-940 RH	Eaton 808709 Euclid E-5491 Meritor / Rockwell R607112	8 5/8"	1 3/4"
18-941 LH	Eaton 808708 Euclid E-5490 Meritor / Rockwell R607111		
18-982 RH	Eaton 807859 Euclid E-9768 Meritor / Rockwell R607152	10 9/16"	1 3/4"
18-983 LH	Eaton 807858 Euclid E-9767 Meritor / Rockwell R607151		
18-942 RH	Eaton 806527 Euclid E-5493 Meritor / Rockwell R607106	11 1/2"	1 3/4"
18-943 LH	Eaton 806526 Euclid E-5492 Meritor / Rockwell R607105		
18-984 RH	Eaton 808291 Euclid E-9770 Meritor / Rockwell R607154	12 1/2"	1 3/4"
18-985 LH	Eaton 808290 Euclid E-9769 Meritor / Rockwell R607153		
18-946 RH	Eaton 808297	13"	1 3/4"
18-947 LH	Eaton 808296		
18-944 RH	Eaton 807863 Euclid E-9772 Meritor / Rockwell R607156	14 1/4"	1 3/4"
18-945 LH	Eaton 807862 Euclid E-9771 Meritor / Rockwell R607155		

Eaton 16 1/2" and 18" Brake

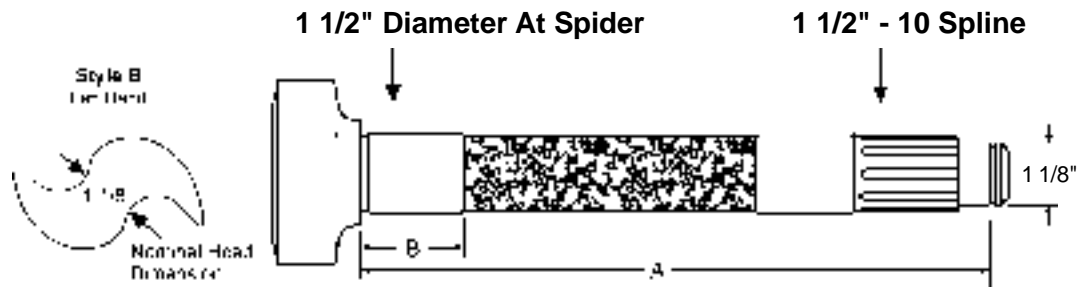

General Information:

- All Cam Lengths ("A" Dim.) Are Measured From Under Cam Head to Beginning of Lock Ring Groove.
- Use Camshaft Repair Kit: 43-7115

Spicer No.	Replaces	A Dim.	B Dim.
18-994 RH	Eaton 808069 Euclid E-10912 Meritor / Rockwell R607280	13 15/32"	1 3/4"
18-995 LH	Eaton 808068 Euclid E-10911 Meritor / Rockwell R607279		
18-996 RH	Eaton 808065 Euclid E-10914 Meritor / Rockwell R607282	15 1/16"	1 3/4"
18-997 LH	Eaton 808064 Euclid E-10913 Meritor / Rockwell R607281		
18-1127 LH	Euclid E-10915 Meritor / Rockwell R607283	15 1/4"	1 3/4"
18-1128 RH	Euclid E-10916 Meritor / Rockwell R607284		

Rockwell 14 1/2" Brake

"W" Brake

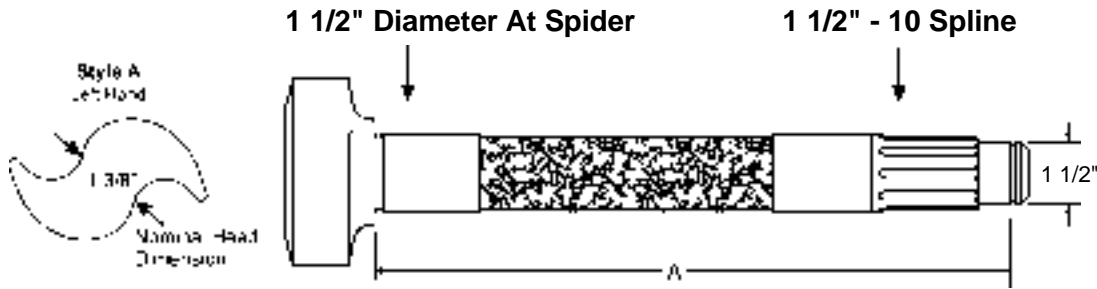

General Information:

· All Cam Lengths ("A" Dim.) Are Measured From Under Cam Head to Beginning of Lock Ring Groove.

Spicer No.	Replaces	A Dim.
18-986 RH	Euclid E-10860	6 1/4"
18-987 LH	Euclid E-10859	
18-988 RH	Euclid E-10862	7 27/32"
18-989 LH	Euclid E-10861	

Rockwell 16 1/2" Brake

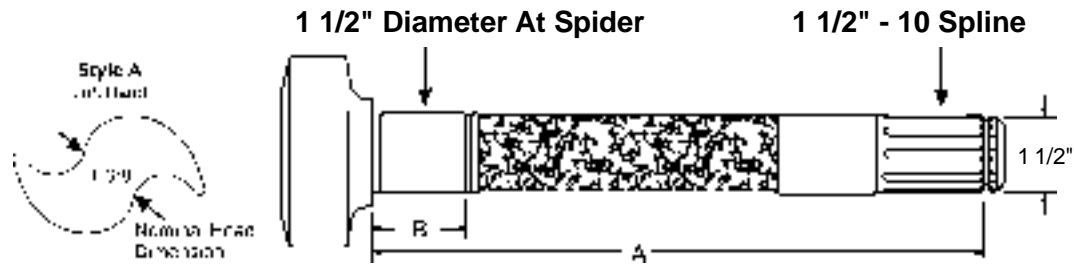

General Information:

- All Cam Lengths ("A" Dim.) Are Measured From Under Cam Head to Beginning of Lock Ring Groove.
- Use Camshaft Repair Kit:
 - 43-7047
 - 43-7048A (Bushing and Seal Kit)
 - 43-7034 (Short Kit - Minus Camshaft Lockring, Camshaft Washer and Anchor Pin Washer)

Spicer No.	Replaces	A Dim.	B Dim.
18-792 RH	Meritor / Rockwell 2210-V-4910	5 3/32"	1 3/4"
18-793 LH	Meritor / Rockwell 2210-U-4909		
18-800 RH	Meritor / Rockwell 2210-A-5721 Meritor / Rockwell 2210-Y-3067 Euclid E-4704A	6 3/8"	1 3/4"
18-801 LH	Meritor / Rockwell 2210-B-5722 Meritor / Rockwell 2210-X-3066 Euclid E-4705A		
18-802 RH	Meritor / Rockwell 2210-H-3024 Meritor / Rockwell 2210-W-5717 Euclid E-4706A	7 7/8"	1 3/4"
18-803 LH	Meritor / Rockwell 2210-J-3026 Meritor / Rockwell 2210-X-5718 Euclid E-4707A		
18-854 RH	Meritor / Rockwell 2210-E-4477 Meritor / Rockwell 2210-E-5543 Euclid E-5056	8 1/16"	1 3/4"
18-855 LH	Meritor / Rockwell 2210-F-4478 Meritor / Rockwell 2210-F-5544 Euclid E-5057		
18-804 RH	Meritor / Rockwell 2210-W-5639 Meritor / Rockwell 2210-X-2442 Euclid E-2478A	8 9/16"	1 3/4"
18-805 LH	Meritor / Rockwell 2210-X-5640 Meritor / Rockwell 2210-Y-2443 Euclid E-2479A		
18-794 RH	Meritor / Rockwell 2210-G-5545 Euclid E-9688	9 3/32"	1 3/4"
18-795 LH	Meritor / Rockwell 2210-H-5546 Euclid E-9687		
18-782 RH	Meritor / Rockwell 2210-Q-5737 Meritor / Rockwell 2210-V-3740	9 31/64"	1 3/4"
18-783 LH	Meritor / Rockwell 2210-R-5738 Meritor / Rockwell 2210-Y-3739		

Continued Next Page

Rockwell 16 1/2" Brake

(Continued)

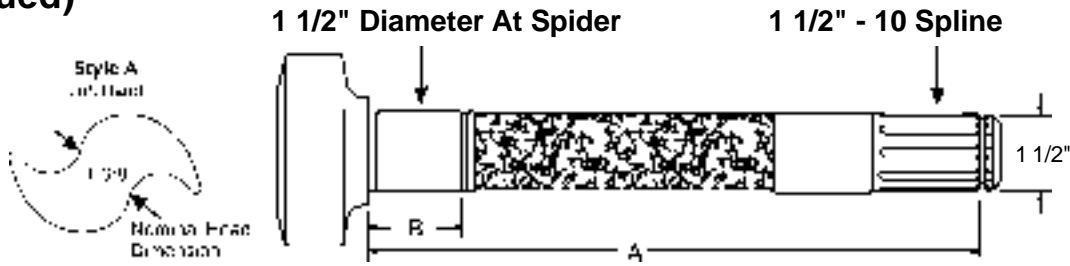

General Information:

- All Cam Lengths ("A" Dim.) Are Measured From Under Cam Head to Beginning of Lock Ring Groove.
- Use Camshaft Repair Kit:
43-7047
43-7048A (Bushing and Seal Kit)
43-7034 (Short Kit - Minus Camshaft Lockring, Camshaft Washer and Anchor Pin Washer)

Spicer No.	Replaces	A Dim.	B Dim.
18-784 RH	Euclid E-1788 Meritor / Rockwell R607017	10 1/4"	1 3/4"
18-785 LH	Euclid E-1789 Meritor / Rockwell R607018		
18-806 RH	Meritor / Rockwell 2210-B-3226 Meritor / Rockwell 2210-D-7180 Meritor / Rockwell 2210-S-5375 Meritor / Rockwell 2210-Y-5381 Euclid E-2700A	10 9/16"	1 3/4"
18-807 LH	Meritor / Rockwell 2210-A-3225 Meritor / Rockwell 2210-E-7181 Meritor / Rockwell 2210-T-5376 Meritor / Rockwell 2210-Z-5382 Euclid E-2701A		
18-808 RH	Meritor / Rockwell 2210-K-3027 Meritor / Rockwell 2210-V-5222 Meritor / Rockwell 2210-W-5353 Meritor / Rockwell 2210-Y-5355 Euclid E-1773B	11 9/32"	1 3/4"
18-809 LH	Meritor / Rockwell 2210-L-3028 Meritor / Rockwell 2210-X-5221 Meritor / Rockwell 2210-X-5354 Meritor / Rockwell 2210-Z-5356 Euclid E-1774B		
18-810 RH	Meritor / Rockwell 2210-C-5359 Meritor / Rockwell 2210-K-5185 Meritor / Rockwell 2210-Q-2981 Euclid E-1147B	11 1/2"	1 3/4"
18-811 LH	Meritor / Rockwell 2210-D-5360 Meritor / Rockwell 2210-L-5186 Meritor / Rockwell 2210-P-2980 Euclid E-1148B		

Continued Next Page

Rockwell 16 1/2" Brake

(Continued)

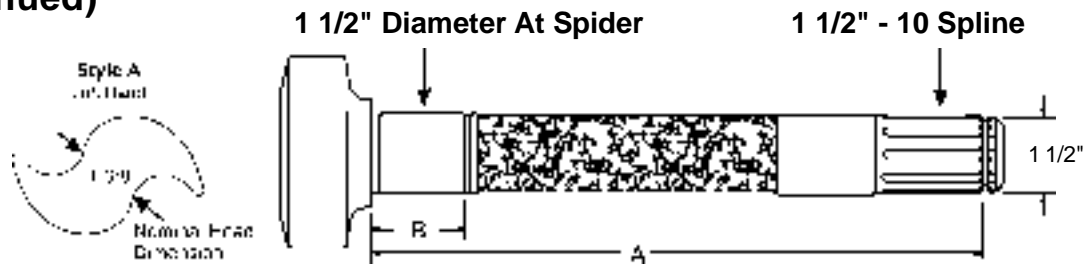

General Information:

- All Cam Lengths ("A" Dim.) Are Measured From Under Cam Head to Beginning of Lock Ring Groove.
- Use Camshaft Repair Kit:
 43-7047
 43-7048A (Bushing and Seal Kit)
 43-7034 (Short Kit - Minus Camshaft Lockring, Camshaft Washer and Anchor Pin Washer)

Spicer No.	Replaces	A Dim.	B Dim.
18-786 RH	Meritor / Rockwell 2210-E-3047 Meritor / Rockwell 2210-Y-5719 Euclid E-4702A	11 3/4"	1 3/4"
18-787 LH	Meritor / Rockwell 2210-D-3046 Meritor / Rockwell 2210-Z-5720 Euclid E-4703A		
18-852 RH	Meritor / Rockwell 2210-C-3097 Meritor / Rockwell 2210-E-5725 Euclid E-2714A	12 1/16"	1 3/4"
18-853 LH	Meritor / Rockwell 2210-D-3098 Meritor / Rockwell 2210-F-5726 Euclid E-4715A		
18-812 RH	Meritor / Rockwell 2210-A-5357 Meritor / Rockwell 2210-F-5310 Meritor / Rockwell 2210-M-2405 Meritor / Rockwell 2210-R-5010 Euclid E-4708A	12 1/2"	1 3/4"
18-813 LH	Meritor / Rockwell 2210-B-5358 Meritor / Rockwell 2210-E-5309 Meritor / Rockwell 2210-L-2404 Meritor / Rockwell 2210-Q-5009 Euclid E-4709A		
18-814 RH	Meritor / Rockwell 2210-F-5050 Meritor / Rockwell 2210-M-5421	13"	1 3/4"
18-815 LH	Meritor / Rockwell 2210-E-5049 Meritor / Rockwell 2210-N-5422		
18-724 RH	Meritor / Rockwell 2210-W-5379 Euclid E-9690	13 21/32"	1 3/4"
18-725 LH	Meritor / Rockwell 2210-X-5380 Euclid E-9689		

Continued Next Page

Rockwell 16 1/2" Brake

(Continued)

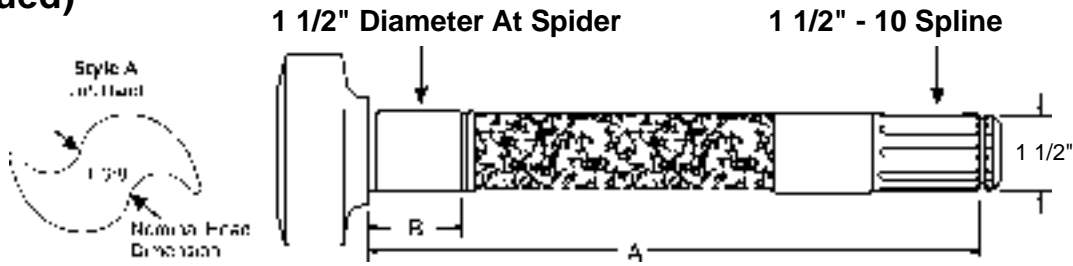

General Information:

- All Cam Lengths ("A" Dim.) Are Measured From Under Cam Head to Beginning of Lock Ring Groove.
- Use Camshaft Repair Kit:
 43-7047
 43-7048A (Bushing and Seal Kit)
 43-7034 (Short Kit - Minus Camshaft Lockring, Camshaft Washer and Anchor Pin Washer)

Spicer No.	Replaces	A Dim.	B Dim.
18-816 RH	Meritor / Rockwell 2210-G-5389 Meritor / Rockwell 2210-S-2567 Euclid E-6881	14 1/8"	1 3/4"
18-817 LH	Meritor / Rockwell 2210-H-5390 Meritor / Rockwell 2210-T-2568 Euclid E-6880		
18-790 RH	Meritor / Rockwell 2210-K-5549 Meritor / Rockwell 2210-S-4465 Euclid E-9692	14 7/8"	1 3/4"
18-791 LH	Meritor / Rockwell 2210-L-5550 Meritor / Rockwell 2210-T-4466 Euclid E-9691		
18-818 RH	Meritor / Rockwell 2210-P-2408 Meritor / Rockwell 2210-U-5637 Euclid E-4710A	15 3/4"	1 3/4"
18-819 LH	Meritor / Rockwell 2210-N-2406 Meritor / Rockwell 2210-V-5638 Euclid E-4711A		

Rockwell 16 1/2" Brake

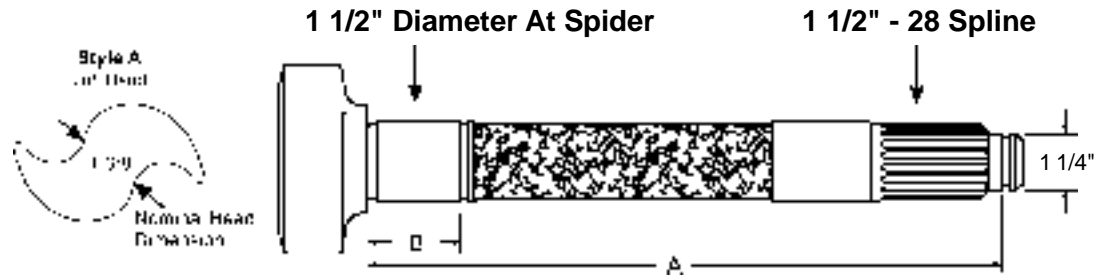

General Information:

- All Cam Lengths ("A" Dim.) Are Measured From Under Cam Head to Beginning of Lock Ring Groove.
- Use Camshaft Repair Kit:
43-7048
43-7048A (Bushings and Seal Kit)

Spicer No.	Replaces	A Dim.	B Dim.
18-796 RH	Meritor / Rockwell 2210-R-5166 Meritor / Rockwell 2210-W-5457 Meritor / Rockwell 2210-Z-7124	7 23/32"	1 3/4"
18-797 LH	Meritor / Rockwell 2210-A-7125 Meritor / Rockwell 2210-S-5167 Meritor / Rockwell 2210-X-5458		
18-860 RH	Meritor / Rockwell 2210-G-5337 Meritor / Rockwell 2210-Q-5139 Euclid E-5000	8 1/8"	1 3/4"
18-861 LH	Meritor / Rockwell 2210-H-5338 Meritor / Rockwell 2210-R-5140 Euclid E-4999		
18-824 RH	Meritor / Rockwell 2210-A-5123 Meritor / Rockwell 2210-E-5439 Euclid E-4897	8 17/32"	1 3/4"
18-825 LH	Meritor / Rockwell 2210-B-5124 Meritor / Rockwell 2210-F-5440 Euclid E-4896		
18-850 RH	Meritor / Rockwell 2210-L-5160 Meritor / Rockwell 2210-U-5455 Euclid E-4899	9 1/16"	1 3/4"
18-851 LH	Meritor / Rockwell 2210-M-5161 Meritor / Rockwell 2210-V-5456 Euclid E-4898		
18-862 RH	Meritor / Rockwell 2210-Q-5373 Meritor / Rockwell 2210-R-5088	9 1/4"	1 3/4"
18-863 LH	Meritor / Rockwell 2210-R-5374 Meritor / Rockwell 2210-S-5089		
18-864 RH	Meritor / Rockwell 2210-S-5427 Meritor / Rockwell 2210-X-5094 Euclid E-4724	9 1/2"	1 3/4"
18-865 LH	Meritor / Rockwell 2210-T-5428 Meritor / Rockwell 2210-Y-5095 Euclid E-4725		

Continued Next Page

Rockwell 16 1/2" Brake

(Continued)

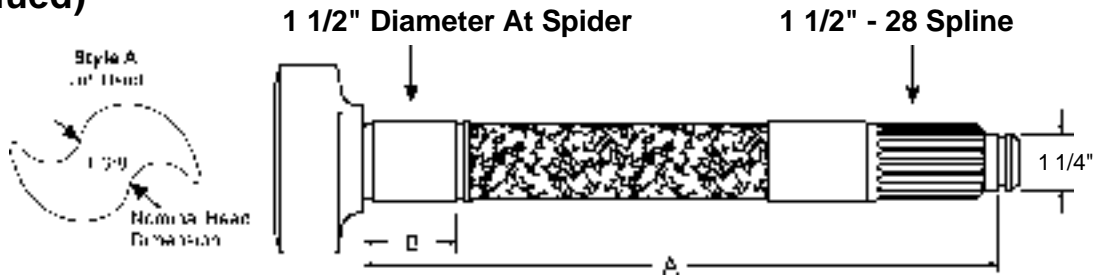

General Information:

- All Cam Lengths ("A" Dim.) Are Measured From Under Cam Head to Beginning of Lock Ring Groove.
- Use Camshaft Repair Kit:
43-7048
43-7048A (Bushings and Seal Kit)

Spicer No.	Replaces	A Dim.	B Dim.
18-888 RH	Meritor / Rockwell 2210-Y-5459	9 3/4"	1 3/4"
18-889 LH	Meritor / Rockwell 2210-Z-5460		
18-710 RH	Meritor / Rockwell 2210-C-6607	10 1/4"	1 3/4"
18-711 LH	Meritor / Rockwell 2210-D-6608		
18-826 RH	Meritor / Rockwell 2210-E-5361 Meritor / Rockwell 2210-V-5092 Euclid E-3348	10 1/2"	1 3/4"
18-827 LH	Meritor / Rockwell 2210-F-5362 Meritor / Rockwell 2210-W-5093 Euclid E-3347		
18-828 RH	Meritor / Rockwell 2210-K-5107 Meritor / Rockwell 2210-Y-5433 Euclid E-4726	10 7/8"	1 3/4"
18-829 LH	Meritor / Rockwell 2210-L-5108 Meritor / Rockwell 2210-Z-5434 Euclid E-4727		
18-798 RH	Meritor / Rockwell 2210-C-6035 Meritor / Rockwell 2210-S-5323 Euclid E-5004	11 1/8"	1 3/4"
18-799 LH	Meritor / Rockwell 2210-D-6036 Meritor / Rockwell 2210-T-5324 Euclid E-5003		
18-830 RH	Meritor / Rockwell 2210-P-5086 Meritor / Rockwell 2210-U-5325 Meritor / Rockwell 2210-Y-5173 Euclid E-3350	11 1/4"	1 3/4"
18-831 LH	Meritor / Rockwell 2210-Q-5087 Meritor / Rockwell 2210-V-5326 Meritor / Rockwell 2210-Z-5174 Euclid E-3349		

Continued Next Page

Rockwell 16 1/2" Brake

(Continued)

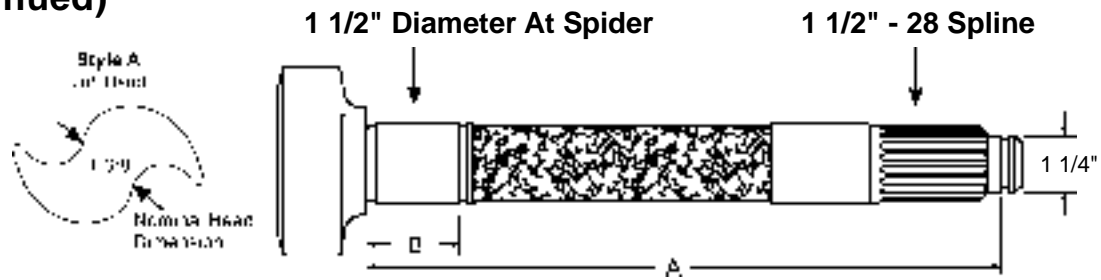

General Information:

- All Cam Lengths ("A" Dim.) Are Measured From Under Cam Head to Beginning of Lock Ring Groove.
- Use Camshaft Repair Kit:
43-7048
43-7048A (Bushings and Seal Kit)

Spicer No.	Replaces	A Dim.	B Dim.
18-832 RH	Meritor / Rockwell 2210-A-5331 Meritor / Rockwell 2210-G-4869 Euclid E-3352	11 1/2"	1 3/4"
18-833 LH	Meritor / Rockwell 2210-B-5332 Meritor / Rockwell 2210-N-4870 Euclid E-3351		
18-866 RH	Meritor / Rockwell 2210-E-5179 Meritor / Rockwell 2210-G-5415 Euclid E-6883	11 5/8"	1 3/4"
18-867 LH	Meritor / Rockwell 2210-F-5180 Meritor / Rockwell 2210-H-5416 Euclid E-6882		
18-868 RH	Meritor / Rockwell 2210-D-5100 Meritor / Rockwell 2210-W-5327 Euclid E-4895	12 1/2"	1 3/4"
18-869 LH	Meritor / Rockwell 2210-E-5101 Meritor / Rockwell 2210-X-5328 Euclid E-4894		
18-836 RH	Meritor / Rockwell 2210-C-5125 Meritor / Rockwell 2210-K-5341 Euclid E-4728	12 15/16"	1 3/4"
18-837 LH	Meritor / Rockwell 2210-D-5126 Meritor / Rockwell 2210-L-5342 Euclid E-4729		
18-820 RH	Meritor / Rockwell 2210-C-5333 Meritor / Rockwell 2210-M-5135 Meritor / Rockwell 2210-T-5090 Euclid E-4730	13 3/16"	1 3/4"
18-821 LH	Meritor / Rockwell 2210-D-5334 Meritor / Rockwell 2210-N-5136 Meritor / Rockwell 2210-U-5091 Euclid E-4731		

Continued Next Page

Rockwell 16 1/2" Brake

(Continued)

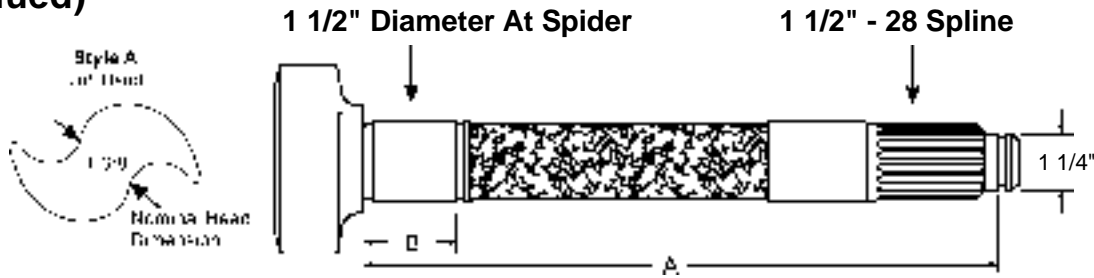

General Information:

- All Cam Lengths ("A" Dim.) Are Measured From Under Cam Head to Beginning of Lock Ring Groove.
- Use Camshaft Repair Kit:
43-7048
43-7048A (Bushings and Seal Kit)

Spicer No.	Replaces	A Dim.	B Dim.
18-822 RH	Meritor / Rockwell 2210-M-5395 Meritor / Rockwell 2210-Z-5096 Euclid E-4732	13 7/16"	1 3/4"
18-823 LH	Meritor / Rockwell 2210-A-5097 Meritor / Rockwell 2210-N-5396 Euclid E-4733		
18-834 RH	Meritor / Rockwell 2210-E-5127 Meritor / Rockwell 2210-M-5369 Euclid E-4734	14 1/16"	1 3/4"
18-835 LH	Meritor / Rockwell 2210-F-5128 Meritor / Rockwell 2210-N-5370 Euclid E-4735		
18-780 RH	Meritor / Rockwell 2210-K-5445 Meritor / Rockwell 2210-X-5147 Euclid E-9082	14 19/32"	1 3/4"
18-781 LH	Meritor / Rockwell 2210-L-5446 Meritor / Rockwell 2210-T-5148 Euclid E-9081		
18-878 RH	Meritor / Rockwell 2210-E-5465	15"	1 3/4"
18-879 LH	Meritor / Rockwell 2210-F-5466		
18-712 RH	Meritor / Rockwell 2210-K-5783 Euclid E-9084	15 3/16"	1 3/4"
18-713 LH	Meritor / Rockwell 2210-L-5784 Euclid E-9083		
18-714 RH	Meritor / Rockwell 2210-Q-5503	15 1/2"	1 3/4"
18-715 LH	Meritor / Rockwell 2210-R-5504		
18-716 RH	Meritor / Rockwell 2210-K-5393 Euclid E-9086	15 23/32"	1 3/4"
18-717 LH	Meritor / Rockwell 2210-L-5394 Euclid E-9085		

Rockwell 16 1/2" Brake

"Q Plus" Brake

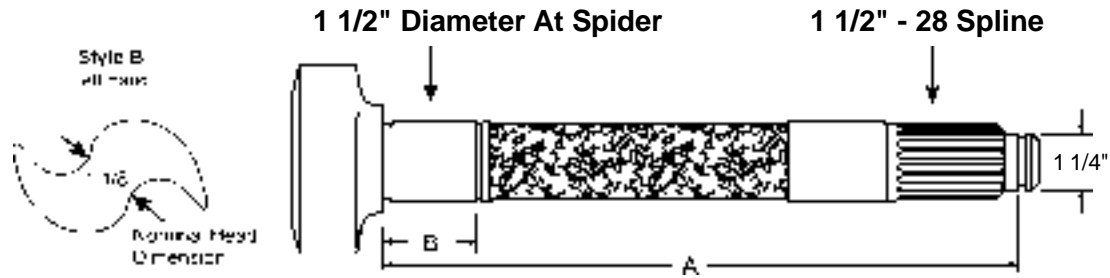

General Information:

- All Cam Lengths ("A" Dim.) Are Measured From Under Cam Head to Beginning of Lock Ring Groove.
- Use Camshaft Repair Kit:
43-7048
43-7048A (Bushings and Seal Kit)

Spicer No.	Replaces	A Dim.	B Dim.
18-500 RH	Meritor / Rockwell 2210-K-7395 Euclid E-9646	7 23/32"	1 13/16"
18-501 LH	Meritor / Rockwell 2210-L-7396 Euclid E-9645		
18-502 RH	Meritor / Rockwell 2210-X-7408 Euclid E-9648	8 1/16"	1 13/16"
18-503 LH	Meritor / Rockwell 2210-Y-7409 Euclid E-9647		
18-504 RH	Meritor / Rockwell 2210-P-7426 Euclid E-9650	8 9/16"	1 13/16"
18-505 LH	Meritor / Rockwell 2210-Q-7427 Euclid E-9649		
18-506 RH	Meritor / Rockwell 2210-F-7442 Euclid E-9652	9 1/16"	1 13/16"
18-507 LH	Meritor / Rockwell 2210-G-7443 Euclid E-9651		
18-508 RH	Meritor / Rockwell 2210-T-7456 Euclid E-9654	9 7/16"	1 13/16"
18-509 LH	Meritor / Rockwell 2210-U-7457 Euclid E-9653		
18-930 RH	Meritor / Rockwell 2210-C-6607 Meritor / Rockwell 2210-H-6820 Meritor / Rockwell 2210-T-7482 Meritor / Rockwell 2210-V-7484 Euclid E-5505	10 3/16"	1 13/16"
18-931 LH	Meritor / Rockwell 2210-D-6608 Meritor / Rockwell 2210-J-6822 Meritor / Rockwell 2210-U-7483 Meritor / Rockwell 2210-U-7485 Euclid E-5504		

NOTE: "Q Plus" cams can be used to replace the standard "Q" cams. However, a "Q" cam cannot be used to replace a "Q Plus" cam.

Continued Next Page

**Rockwell 16 1/2" Brake
(Continued)**

"Q Plus" Brake

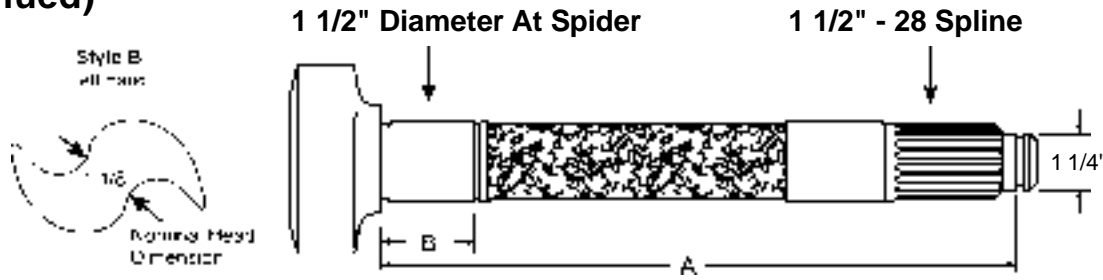

General Information:

- All Cam Lengths ("A" Dim.) Are Measured From Under Cam Head to Beginning of Lock Ring Groove.
- Use Camshaft Repair Kit:
43-7048
43-7048A (Bushings and Seal Kit)

Spicer No.	Replaces	A Dim.	B Dim.
18-510 RH	Meritor / Rockwell 2210-D-7492 Euclid E-9656	10 13/32"	1 13/16"
18-511 LH	Meritor / Rockwell 2210-E-7493 Euclid E-9655		
18-512 RH	Meritor / Rockwell 2210-K-7499	10 1/2"	1 13/16"
18-513 LH	Meritor / Rockwell 2210-L-7500		
18-514 RH	Meritor / Rockwell 2210-Z-7514 Euclid E-9658	10 15/16"	1 13/16"
18-515 LH	Meritor / Rockwell 2210-A-7515 Euclid E-9657		
18-516 RH	Meritor / Rockwell 2210-H-7522 Euclid E-9660	11 1/8"	1 13/16"
18-517 LH	Meritor / Rockwell 2210-J-7524 Euclid E-9659		
18-518 RH	Meritor / Rockwell 2210-V-7536 Euclid E-9662	11 9/16"	1 13/16"
18-519 LH	Meritor / Rockwell 2210-W-7537 Euclid E-9661		
18-520 RH	Meritor / Rockwell 2210-B-7542 Euclid E-9664	11 11/16"	1 13/16"
18-521 LH	Meritor / Rockwell 2210-C-7543 Euclid E-9663		
18-522 RH	Meritor / Rockwell 2210-K-7551 Euclid E-9666	11 15/16"	1 13/16"
18-523 LH	Meritor / Rockwell 2210-L-7552 Euclid E-9665		
18-524 RH	Meritor / Rockwell 2210-B-7568 Euclid E-9668	12 7/16"	1 13/16"
18-525 LH	Meritor / Rockwell 2210-C-7569 Euclid E-9667		

NOTE: "Q Plus" cams can be used to replace the standard "Q" cams. However, a "Q" cam cannot be used to replace a "Q Plus" cam.

Continued Next Page

**Rockwell 16 1/2" Brake
(Continued)**

"Q Plus" Brake

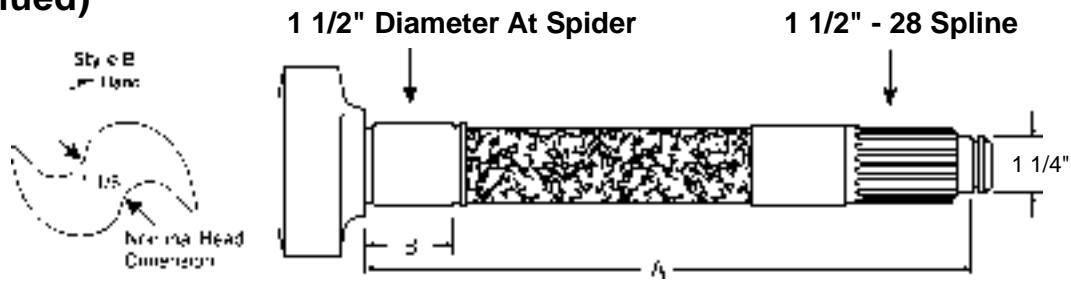

General Information:

- All Cam Lengths ("A" Dim.) Are Measured From Under Cam Head to Beginning of Lock Ring Groove.
- Use Camshaft Repair Kit:
43-7048
43-7048A (Bushings and Seal Kit)

Spicer No.	Replaces	A Dim.	B Dim.
18-526 RH	Meritor / Rockwell 2210-T-7586 Euclid E-9670	12 15/16"	1 13/16"
18-527 LH	Meritor / Rockwell 2210-U-7587 Euclid E-9669		
18-528 RH	Meritor / Rockwell 2210-B-7594 Euclid E-9672	13 7/32"	1 13/16"
18-529 LH	Meritor / Rockwell 2210-C-7595 Euclid E-9671		
18-530 RH	Meritor / Rockwell 2210-K-7603	13 7/16"	1 13/16"
18-531 LH	Meritor / Rockwell 2210-L-7604		
18-532 RH	Meritor / Rockwell 2210-K-7837 Euclid E-9674A	13 1/2"	1 13/16"
18-533 LH	Meritor / Rockwell 2210-L-7838 Euclid E-9673A		
18-534 RH	Meritor / Rockwell 2210-H-7626 Euclid E-9676	14 3/32"	1 13/16"
18-535 LH	Meritor / Rockwell 2210-J-7628 Euclid E-9675		
18-536 RH	Meritor / Rockwell 2210-Z-7644 Euclid E-9678	14 19/32"	1 13/16"
18-537 LH	Meritor / Rockwell 2210-A-7645 Euclid E-9677		
18-538 RH	Meritor / Rockwell 2210-H-7652 Euclid E-9680	14 3/4"	1 13/16"
18-539 LH	Meritor / Rockwell 2210-J-7654 Euclid E-9679		
18-540 RH	Meritor / Rockwell 2210-Z-7670 Euclid E-9682	15 3/16"	1 13/16"
18-541 LH	Meritor / Rockwell 2210-A-7671 Euclid E-9681		

NOTE: "Q Plus" cams can be used to replace the standard "Q" cams. However, a "Q" cam cannot be used to replace a "Q Plus" cam.

Continued Next Page

Rockwell 16 1/2" Brake
(Continued)

"Q Plus" Brake

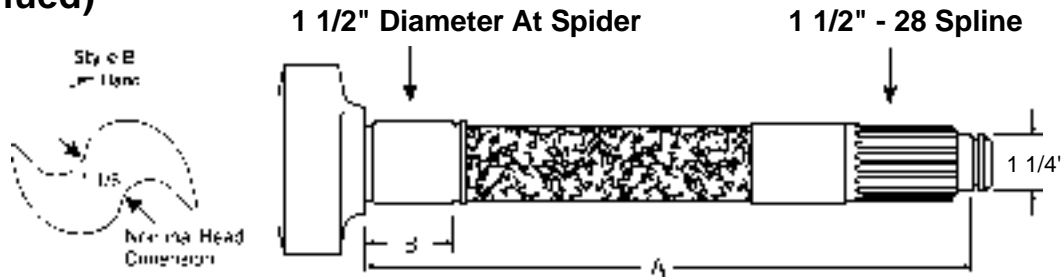

General Information:

- All Cam Lengths ("A" Dim.) Are Measured From Under Cam Head to Beginning of Lock Ring Groove.
- Use Camshaft Repair Kit:
43-7048
43-7048A (Bushings and Seal Kit)

Spicer No.	Replaces	A Dim.	B Dim.
18-542 RH	Meritor / Rockwell 2210-R-7688 Euclid E-9684	15 23/32"	1 13/16"
18-543 LH	Meritor / Rockwell 2210-S-7689 Euclid E-9683		

NOTE: "Q Plus" cams can be used to replace the standard "Q" cams. However, a "Q" cam cannot be used to replace a "Q Plus" cam.

Spicer 16 1/2" x 5", 6" and 7" Brakes

"XL" and "XLII" Brakes

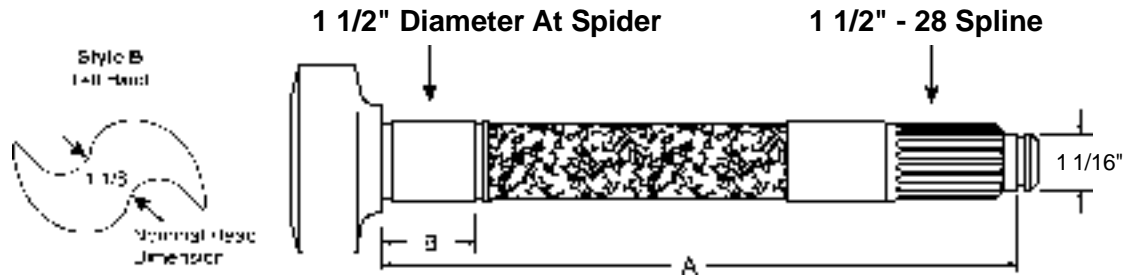

General Information:

- All Cam Lengths ("A" Dim.) Are Measured From Under Cam Head to Cam End.
- Use Camshaft Repair Kit: 43-7081

Spicer No.	Replaces	A Dim.	B Dim.
18-670 RH	Spicer OE 165WK111-12	6 15/16"	1 25/32"
18-671 LH	Spicer OE 165WK110-12		
18-672 RH	Spicer OE 165WK111-11	9 7/8"	1 25/32"
18-673 LH	Spicer OE 165WK110-11		
18-674 RH	Spicer OE 165WK111-13	10 15/32"	1 25/32"
18-675 LH	Spicer OE 165WK110-13		
18-676 RH	Spicer OE 165WK111-1	11 3/16"	1 25/32"
18-677 LH	Spicer OE 165WK110-1		
18-678 RH	Spicer OE 165WK111-14	12 7/16"	1 25/32"
18-679 LH	Spicer OE 165WK110-14		
18-680 RH	Spicer OE 165WK111-3	13 9/32"	1 25/32"
18-681 LH	Spicer OE 165WK110-3		
18-682 RH	Spicer OE 165WK111-4	14 9/16"	1 25/32"
18-683 LH	Spicer OE 165WK110-4		
18-684 RH	Spicer OE 165WK111-9	15 19/32"	1 25/32"
18-685 LH	Spicer OE 165WK110-9		
18-688 RH	Spicer OE 165WK111-16	17 1/16"	1 25/32"
18-689 LH	Spicer OE 165WK110-16		

Spicer 16 1/2" x 5", 6" and 7" Brakes

"XL" and "XLII" Brakes

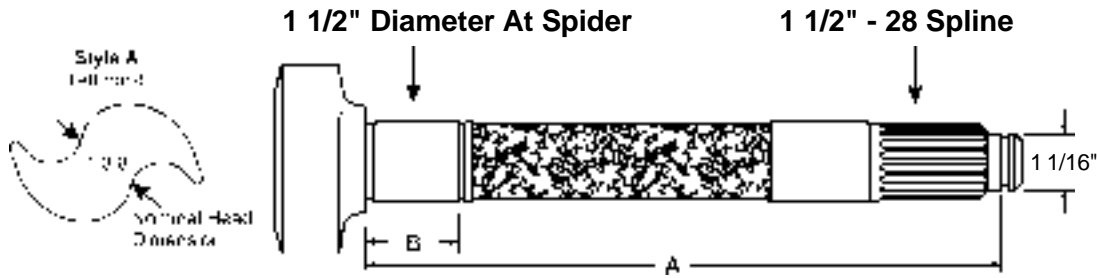

General Information:

- All Cam Lengths ("A" Dim.) Are Measured From Under Cam Head to Cam End.
- Use Camshaft Repair Kit: 43-7081

Spicer No.	Replaces	A Dim.	B Dim.
18-640 RH	Spicer OE 165WK104-8	7 3/4"	1 25/32"
18-641 LH	Spicer OE 165WK105-8		
18-642 RH	Spicer OE 165WK104-4	8 1/8"	1 25/32"
18-643 LH	Spicer OE 165WK105-4		
18-644 RH	Spicer OE 165WK104-2	8 1/2"	1 25/32"
18-645 LH	Spicer OE 165WK105-2		
18-646 RH	Spicer OE 165WK104-9	9 1/32"	1 25/32"
18-647 LH	Spicer OE 165WK105-9		
18-648 RH	Spicer OE 165WK104-13	10 15/32"	1 25/32"
18-649 LH	Spicer OE 165WK105-13		
18-650 RH	Spicer OE 165WK104-1	11 3/16"	1 25/32"
18-651 LH	Spicer OE 165WK105-1		
18-652 RH	Spicer OE 165WK104-7	11 1/2"	1 25/32"
18-653 LH	Spicer OE 165WK105-7		
18-654 RH	Spicer OE 165WK104-5	12 15/64"	1 25/32"
18-655 LH	Spicer OE 165WK105-5		
18-656 RH	Spicer OE 165WK104-3	12 15/16"	1 25/32"
18-657 LH	Spicer OE 165WK105-3		
18-658 RH	Spicer OE 165WK104-6	13 1/8"	1 25/32"
18-659 LH	Spicer OE 165WK105-6		
18-660 RH	Spicer OE 165WK104-11	13 7/16"	1 25/32"
18-661 LH	Spicer OE 165WK105-11		

Dexter 12 1/4" Brake

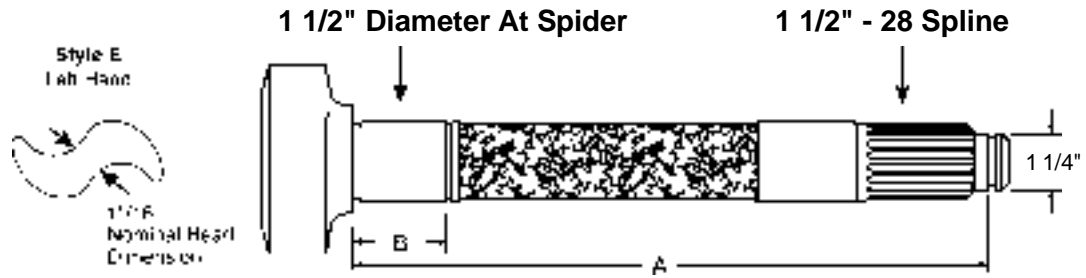

General Information:

- All Cam Lengths ("A" Dim.) Are Measured From Under Cam Head to Cam End.
- Use Camshaft Repair Kit: 43-7033

Spicer No.	Replaces	A Dim.	B Dim.
17-11057 LH	Dexter 034-188-01 Euclid E-10917 Meritor / Rockwell R607285	16 3/8"	2 7/32"
17-11058 RH	Dexter 034-189-01 Euclid E-10918 Meritor / Rockwell R607286		
17-11059 LH	Dexter 034-188-04 Euclid E-10919 Meritor / Rockwell R607287	20 5/16"	2 7/32"
17-11060 RH	Dexter 034-189-04 Euclid E-10920 Meritor / Rockwell R607288		
17-11061 LH	Dexter 034-188-00 Euclid E-10921 Meritor / Rockwell R607289	21 1/8"	2 7/32"
17-11062 RH	Dexter 034-189-00 Euclid E-10922 Meritor / Rockwell R607290		
17-11063 LH	Dexter 034-188-03 Euclid E-10923 Meritor / Rockwell R607291	22 5/16"	2 7/32"
17-11064 RH	Dexter 034-189-03 Euclid E-10924 Meritor / Rockwell R607292		
17-11065 LH	Dexter 034-188-05 Euclid E-10925 Meritor / Rockwell R607293	23 3/8"	2 7/32"
17-11066 RH	Dexter 034-189-05 Euclid E-10926 Meritor / Rockwell R607294		
17-11067 LH	Dexter 034-188-11 Euclid E-10927 Meritor / Rockwell R607295	24 5/8"	2 7/32"
17-11068 RH	Dexter 034-189-11 Euclid E-10928 Meritor / Rockwell R607296		

Continued Next Page

Dexter 12 1/4" Brake

(Continued)

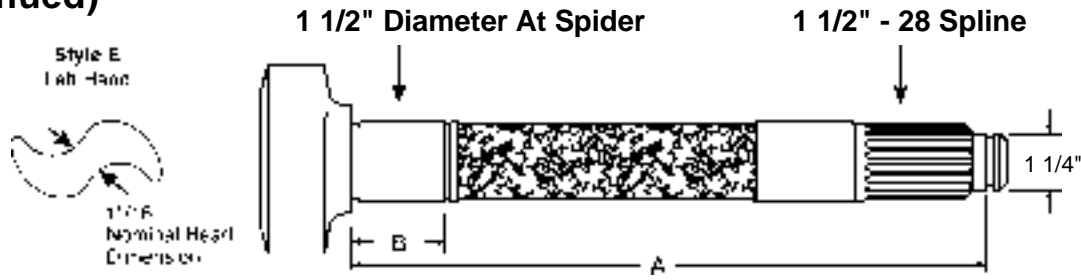

General Information:

- All Cam Lengths ("A" Dim.) Are Measured From Under Cam Head to Cam End.
- Use Camshaft Repair Kit: 43-7033

Spicer No.	Replaces	A Dim.	B Dim.
17-11069 LH	Dexter 034-188-09 Euclid E-10929 Meritor / Rockwell R607297	26 1/2"	2 7/32"
17-11070 RH	Dexter 034-189-09 Euclid E-10930 Meritor / Rockwell R607298		

Eaton 16 1/2" Brake

Single Anchor Pin (SAP) Brake, 501 Series Axle

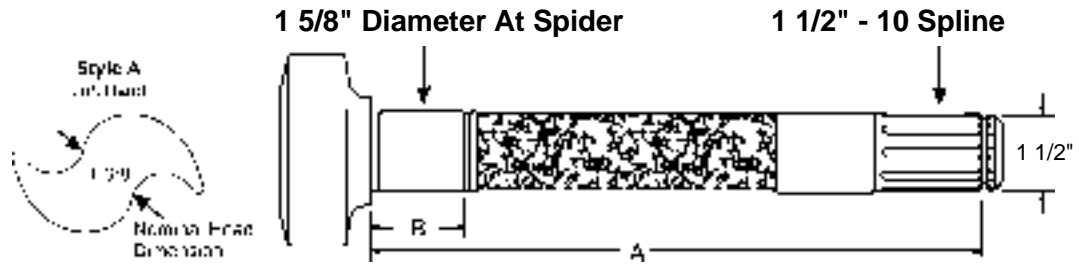

General Information:

- All Cam Lengths ("A" Dim.) Are Measured From Under Cam Head to Beginning of Lock Ring Groove.
- Refer To Camshaft Enclosures Section For Detailed Information.
- Use Camshaft Repair Kit: 43-7043A

Spicer No.	Replaces	A Dim.	B Dim.
17-634 RH	Eaton 125035 Eaton Top Spec 7-2408 Euclid E-2694 Meritor / Rockwell R607025	19 1/2"	2 7/32"
17-635 LH	Eaton 125034 Eaton Top Spec 7-2407 Euclid E-2693 Meritor / Rockwell R607026		
17-636 RH	Eaton 125031 Euclid E-4720 Meritor / Rockwell R607045	23 3/4"	2 7/32"
17-637 LH	Eaton 125030 Euclid E-4721 Meritor / Rockwell R607046		

Eaton 16 1/2" Brake

Single Anchor Pin (SAP) Brake, 501 Series Axle

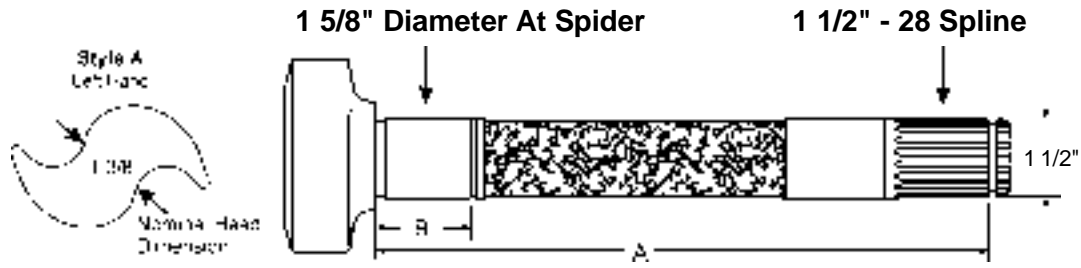

General Information:

- All Cam Lengths ("A" Dim.) Are Measured From Under Cam Head to Beginning of Lock Ring Groove.
- Use Camshaft Repair Kit: 43-7043A

Spicer No.	Replaces	A Dim.	B Dim.
17-638 RH	Eaton 125043 Euclid E-4722 Meritor / Rockwell R607047	20 7/32"	2 5/32"
17-639 LH	Eaton 125042 Euclid E-4723 Meritor / Rockwell R607048		

Eaton 16 1/2" Brake

Extended Service (ES™) Brake

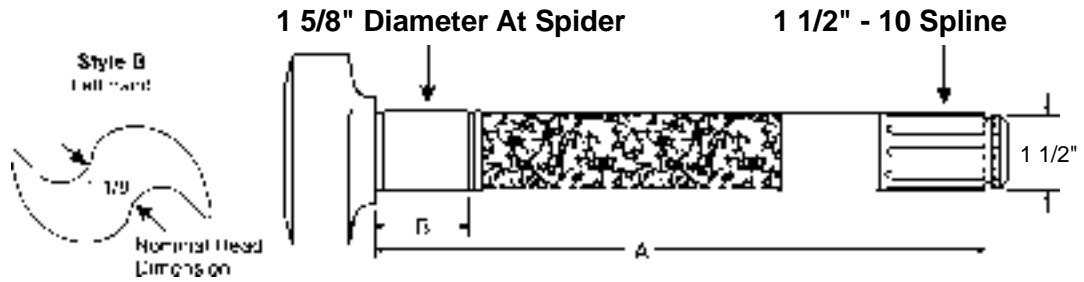

General Information:

- All Cam Lengths ("A" Dim.) Are Measured From Under Cam Head to Beginning of Lock Ring Groove.
- Use Camshaft Repair Kit: 43-7043A

Spicer No.	Replaces	A Dim.	B Dim.
17-460 RH	Eaton 808079 Euclid E-5495 Meritor / Rockwell R607110	19 3/8"	2 7/32"
17-461 LH	Eaton 808078 Euclid E-5494 Meritor / Rockwell R607109		
17-462 RH	Eaton 806655 Euclid E-5497 Meritor / Rockwell R607108	23 5/8"	2 7/32"
17-463 LH	Eaton 806654 Euclid E-5496 Meritor / Rockwell R607107		

Eaton 16 1/2" Brake

Extended Service (ES™) Brake

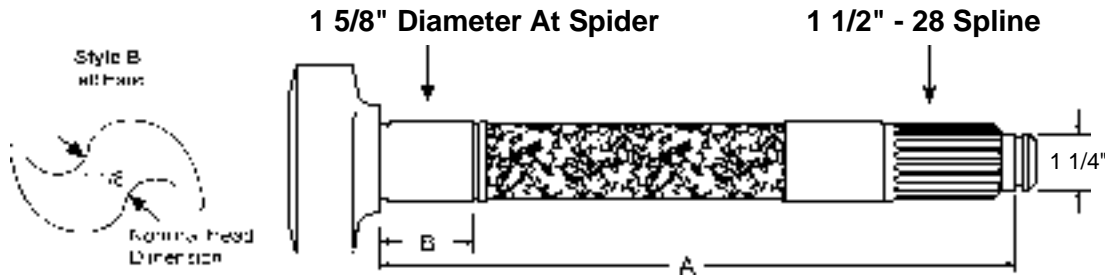

General Information:

- All Cam Lengths ("A" Dim.) Are Measured From Under Cam Head to Beginning of Lock Ring Groove.
- Use Camshaft Repair Kit: 43-7043A

Spicer No.	Replaces	A Dim.	B Dim.
17-470 RH	Eaton 810539 Euclid E-9058 Meritor / Rockwell R607116	19 3/8"	2 7/32"
17-471 LH	Eaton 810538 Euclid E-9057 Meritor / Rockwell R607115		
17-472 RH	Eaton 810026 Euclid E-9060 Meritor / Rockwell R607114	23 5/8"	2 7/32"
17-473 LH	Eaton 810025 Euclid E-9059 Meritor / Rockwell R607113		

Eaton Shuler 12 1/4" Brake

Single Anchor Pin (SAP) Brake

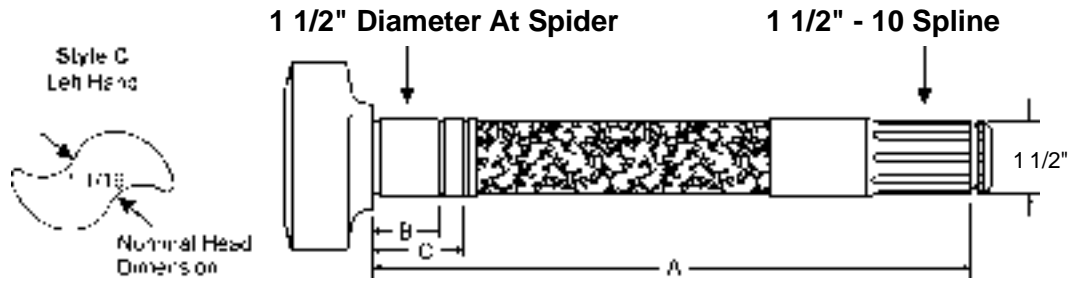

General Information:

- All Cam Lengths ("A" Dim.) Are Measured From Under Cam Head to Beginning of Lock Ring Groove.
- Double Grooved, Can Be Used On Narrow Or Wide Boss Spiders.
- Refer To Camshaft Enclosure Section For Detailed Information.
- Use Camshaft Repair Kit: 43-7040

Spicer No.	Replaces	A Dim.	B Dim.	C Dim.
17-682 RH	Eaton Top Spec 7-2409 Eaton B-2460-38 Euclid E-1393 Meritor / Rockwell R607003	20 5/16"	1 11/32"	2 7/32"
17-683 LH	Eaton Top Spec 7-2410 Eaton B-2460-37 Euclid E-1394 Meritor / Rockwell R607004	20 5/16"	1 11/32"	2 7/32"
17-698 RH	Eaton Top Spec 7-2421 Eaton 820239 Euclid E-2492 Meritor / Rockwell R607023	22 5/16"	1 11/32"	2 7/32"
17-699 LH	Eaton Top Spec 7-2422 Eaton 820240 Euclid E-2493 Meritor / Rockwell R60724	22 5/16"	1 11/32"	2 7/32"

Eaton Shuler 16 1/2" Brake

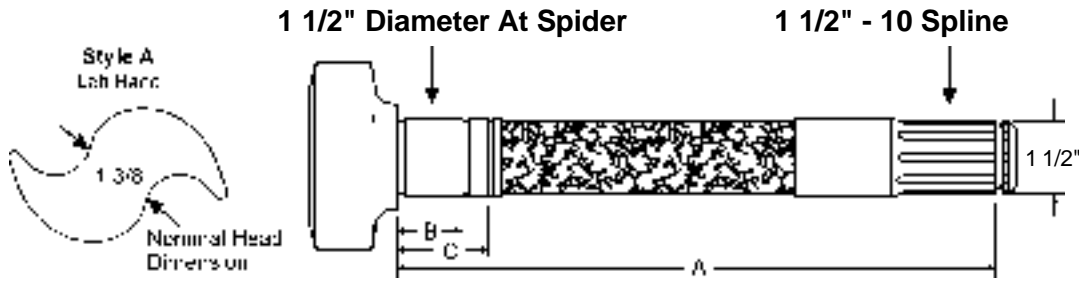

General Information:

- All Cam Lengths ("A" Dim.) Are Measured From Under Cam Head to Cam End.
- Double Grooved
- Use Camshaft Repair Kit: 43-7040

Spicer No.	Replaces	A Dim.	B Dim.	C Dim.
17-11071 LH	Eaton 820073 Euclid E-2107 Meritor / Rockwell R607022	20 3/8"	1 5/8"	2 7/32"
17-11072 RH	Eaton 820074 Euclid E-2108 Meritor / Rockwell R607021			

Fruehauf 12 1/4" Brake

"Pro-Par" Type Axle

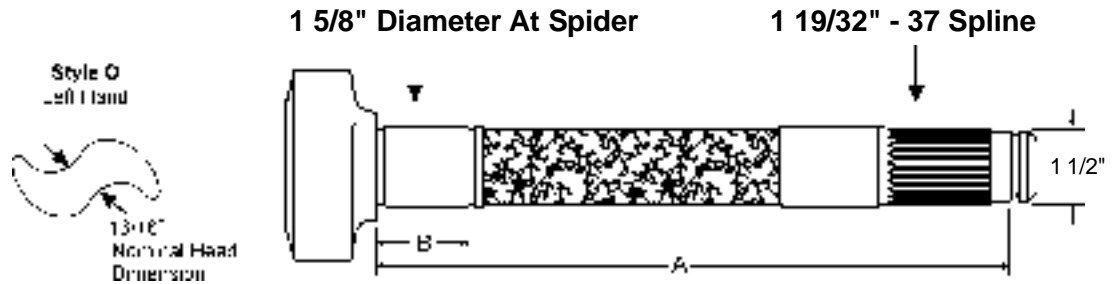

General Information:

- All Cam Lengths ("A" Dim.) Are Measured From Under Cam Head to Beginning of Lock Ring Groove.
- Air Suspension 17-618, 17-619
- Use Camshaft Repair Kit:
 - 43-7038 (Early Model Cam Bracket Bushing)
 - 43-7039 (Late Model (Spherical) Cam Bracket Bushing)
 - 43-7039A (New Design Outboard S-Camshaft Bracket Assembly)

Spicer No.	Replaces	A Dim.	B Dim.
17-624 RH	Fruehauf ACD-2193-2 Euclid E-1584 Meritor / Rockwell R607260	16 3/16"	2 15/64"
17-625 LH	Fruehauf ACD-2193-1 Euclid E-1585 Meritor / Rockwell R607259		
17-618 RH	Fruehauf ACD-2193-5 Euclid E-4891 Meritor / Rockwell R607264	21 3/16"	2 15/64"
17-619 LH	Fruehauf ACD-2193-6 Euclid E-4890 Meritor / Rockwell R607263		

Fruehauf 16 1/2" Brake

"Pro-Par" Type Axle

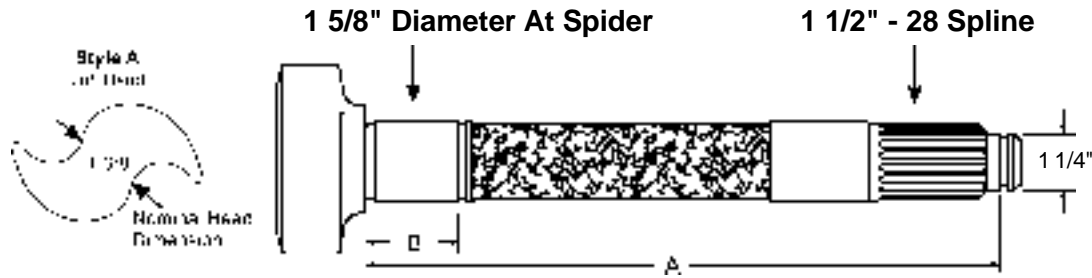

General Information:

- All Cam Lengths ("A" Dim.) Are Measured From Under Cam Head to Beginning of Lock Ring Groove.
- Use Camshaft Repair Kit:
 - 43-7038 (Early Model Cam Bracket Bushing)
 - 43-7039 (Late Model (Spherical) Cam Bracket Bushing)
 - 43-7039A (New Design Outboard S-Camshaft Bracket Assembly)

Spicer No.	Replaces	A Dim.	B Dim.
17-614 RH	Fruehauf APA-0998-2 Euclid E-9762 Meritor / Rockwell R607164	16 1/8"	2 5/32"
17-615 LH	Fruehauf APA-0998-1 Euclid E-9761 Meritor / Rockwell R607163		

Fruehauf 16 1/2" Brake

"Pro-Par" Type Axle

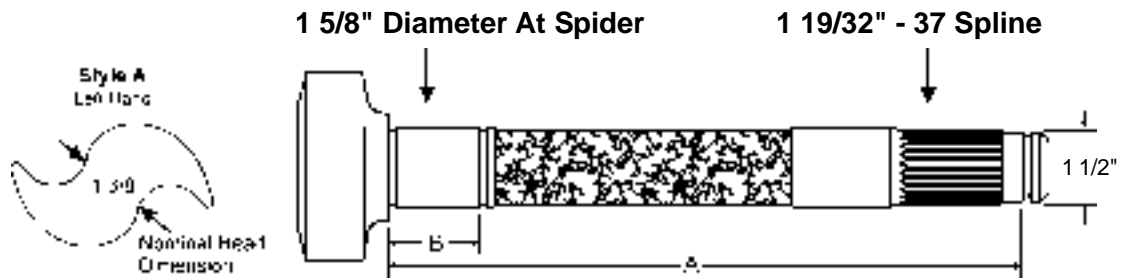

General Information:

- All Cam Lengths ("A" Dim.) Are Measured From Under Cam Head to Beginning of Lock Ring Groove.
- Air Suspension: 17-622, 17-623, 17-616, 17-617
- Refer to Camshaft Enclosure Section For Detailed Information
- Use Camshaft Repair Kit:
 - 43-7038 (Early Model Cam Bracket Bushing)
 - 43-7039 (Late Model (Spherical) Cam Bracket Bushing)
 - 43-7039A (New Design Outboard S-Camshaft Bracket Assembly)

Spicer No.	Replaces	A Dim.	B Dim.
17-620 RH	Fruehauf AXA-0420-2 Euclid E-1564 Meritor / Rockwell R607012	16 1/8"	2 15/64"
17-621 LH	Fruehauf AXA-0420-1 Euclid E-1563 Meritor / Rockwell R607011		
17-622 RH	Fruehauf AXA-0420-4 Euclid E-2100 Meritor / Rockwell R607019	21 1/8"	2 15/64"
17-623 LH	Fruehauf AXA-0420-3 Euclid E-2099 Meritor / Rockwell R607020		
17-616 RH	Fruehauf AXA-0420-5 Euclid E-3862 Meritor / Rockwell R607161	23 7/8"	2 15/64"
17-617 LH	Fruehauf AXA-0420-6 Euclid E-3861 Meritor / Rockwell R607162		

Intraax 16 1/2" Brake

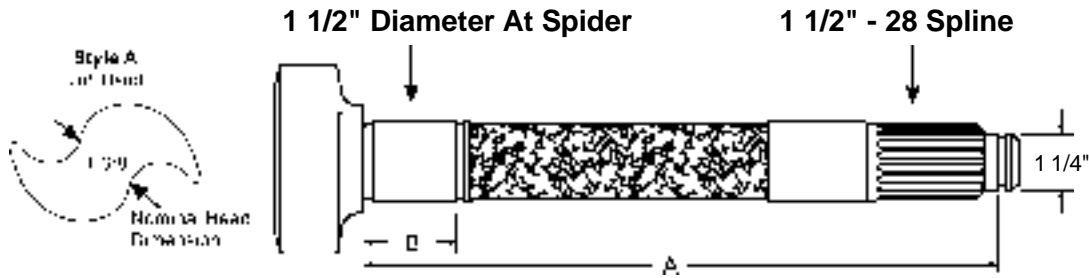

General Information:

- All Cam Lengths ("A" Dim.) Are Measured From Under Cam Head to Cam End.
- Use Camshaft Repair Kit: 43-7090

Spicer No.	Replaces	A Dim.	B Dim.
17-11055 LH	Euclid E-10899 Meritor / Rockwell R607267 Intraax S-20806-1L	11 3/32"	2 9/32"
17-11056 RH	Euclid E-10900 Meritor / Rockwell R607268 Intraax S-20806-1R		

Multi-application 16 1/2" Brake

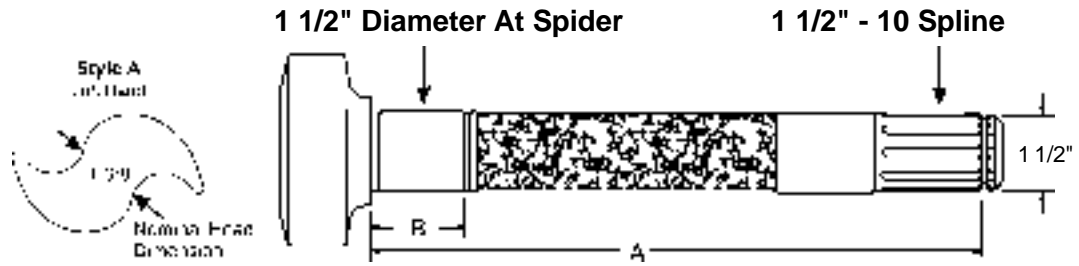

General Information:

- All Cam Lengths ("A" Dim.) Are Measured From Under Cam Head to Beginning of Lock Ring Groove.
- Refer to Camshaft Enclosure Section For Detailed Information.
- Use Camshaft Repair Kit:
 - 43-7032 (Spicer Weld-On Spider with Nylon Bushings)
 - 43-7032A (Spicer Weld-On Spider with Bronze Bushings)
 - 43-7044 (Rockwell RN Series, Contains Complete S-Cam Bracket Assembly)
 - 43-7044A (Rockwell RN Series, Contains S-Cam Bracket Bushings Only)
 - 43-7046 (Rockwell TKL Series, Early Style 2 Piece Spider Bushing)
 - 43-7046A (Rockwell TKL Series, Late Style 1 Piece Spider Bushing)
 - 43-7117 (Weld-On Spider with Bronze Bushings and New Style Bracket Assembly)

Spicer No.	Replaces	A Dim.	B Dim.	General Information
17-560 RH	Euclid E-9710 Spicer OE M16WK103-5 Meritor / Rockwell R607220	15 5/8"	2 7/32"	Spicer, Rockwell, Granning
17-561 LH	Euclid E-9709 Spicer OE M16WK102-5 Meritor / Rockwell R607219			
17-570 RH	Euclid E-4712 Spicer OE M16WKR10-165 Meritor / Rockwell R607039	16 5/16"	2 7/32"	
17-571 LH	Euclid E-4713 Spicer OE M16WKL10-165 Meritor / Rockwell R607040			
17-576 RH	Meritor / Rockwell 2210-G-2555 Meritor / Rockwell 2210-R-2488 Euclid E-686 Spicer OE M16WKR10-166	16 1/2"	2 7/32"	
17-577 LH	Meritor / Rockwell 2210-A-2556 Meritor / Rockwell 2210-S-2489 Euclid E-687 Spicer OE M16WKL10-166			
17-572 RH	Meritor / Rockwell 2210-B-6008 Meritor / Rockwell 2210-N-2562 Meritor / Rockwell 2210-Q-5711 Euclid E-4714	17 3/4"	2 7/32"	
17-573 LH	Meritor / Rockwell 2210-A-6007 Meritor / Rockwell 2210-P-2564 Meritor / Rockwell 2210-R-5712 Euclid E-4715			

Continued Next Page

Multi-application 16 1/2" Brake

(Continued)

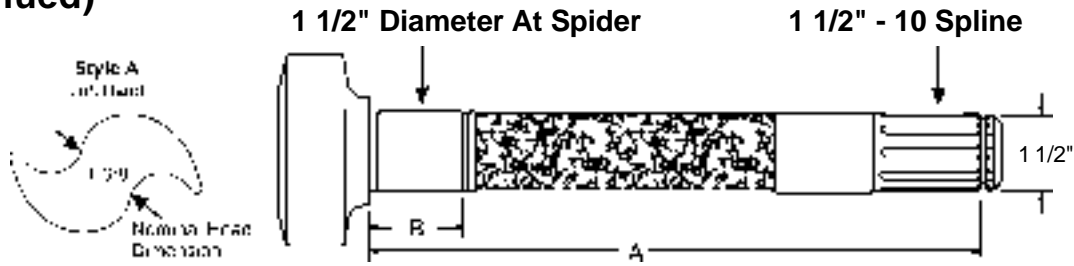

General Information:

- All Cam Lengths ("A" Dim.) Are Measured From Under Cam Head to Beginning of Lock Ring Groove.
- Refer to Camshaft Enclosure Section For Detailed Information.
- Use Camshaft Repair Kit:
 - 43-7032 (Spicer Weld-On Spider with Nylon Bushings)
 - 43-7032A (Spicer Weld-On Spider with Bronze Bushings)
 - 43-7044 (Rockwell RN Series, Contains Complete S-Cam Bracket Assembly)
 - 43-7044A (Rockwell RN Series, Contains S-Cam Bracket Bushings Only)
 - 43-7046 (Rockwell TKL Series, Early Style 2 Piece Spider Bushing)
 - 43-7046A (Rockwell TKL Series, Late Style 1 Piece Spider Bushing)
 - 43-7117 (Weld-On Spider with Bronze Bushings and New Style Bracket Assembly)

Spicer No.	Replaces	A Dim.	B Dim.
17-566 RH	Meritor / Rockwell 2210-W-2337 Eaton B1691-6 Euclid E-688 Meritor / Rockwell R607102	18 3/8"	2 7/32"
17-567 LH	Meritor / Rockwell 2210-X-2338 Eaton B1691-5 Euclid E-689 Meritor / Rockwell R607101		
17-578 RH	Meritor / Rockwell 2210-D-1434 Meritor / Rockwell 2210-J-2558 Meritor / Rockwell 2210-U-5533 Eaton Top Spec 7-2403 Eaton B1691-46 Euclid E-2412	18 5/8"	2 7/32"
17-579 LH	Meritor / Rockwell 2210-E-1435 Meritor / Rockwell 2210-K-2559 Meritor / Rockwell 2210-V-5534 Eaton Top Spec 7-2404 Eaton B1691-45 Euclid E-2413		
17-582 RH	Meritor / Rockwell 2210-Z-6318 Euclid E-684 Spicer OE M16WKR10-213	21 1/8"	2 7/32"
17-583 LH	Meritor / Rockwell 2210-A-6319 Euclid E-685 Spicer OE M16WKL10-213		

Continued Next Page

Multi-application 16 1/2" Brake

(Continued)

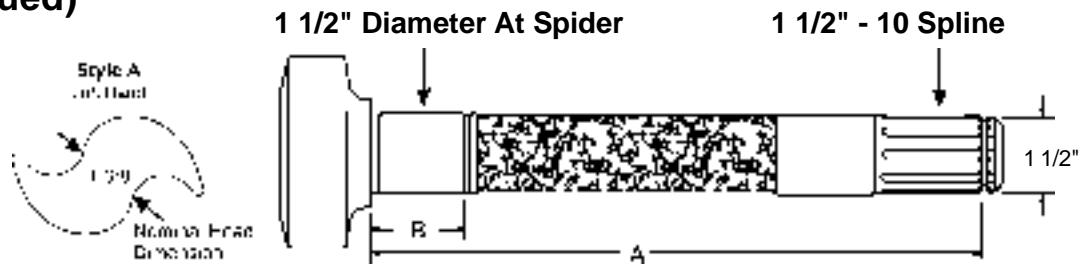

General Information:

- All Cam Lengths ("A" Dim.) Are Measured From Under Cam Head to Beginning of Lock Ring Groove.
- Refer to Camshaft Enclosure Section For Detailed Information.
- Use Camshaft Repair Kit:
 - 43-7032 (Spicer Weld-On Spider with Nylon Bushings)
 - 43-7032A (Spicer Weld-On Spider with Bronze Bushings)
 - 43-7044 (Rockwell RN Series, Contains Complete S-Cam Bracket Assembly)
 - 43-7044A (Rockwell RN Series, Contains S-Cam Bracket Bushings Only)
 - 43-7046 (Rockwell TKL Series, Early Style 2 Piece Spider Bushing)
 - 43-7046A (Rockwell TKL Series, Late Style 1 Piece Spider Bushing)
 - 43-7117 (Weld-On Spider with Bronze Bushings and New Style Bracket Assembly)

Spicer No.	Replaces	A Dim.	B Dim.
17-584 RH	Meritor / Rockwell 2210-H-2946 Euclid E-9090	22 3/8"	2 7/32"
17-585 LH	Meritor / Rockwell 2210-J-2948 Euclid E-9089		
17-594 RH	Meritor / Rockwell 2210-Z-6344 Euclid E-4885 Spicer OE M16WKR10-231	22 7/8"	2 7/32"
17-595 LH	Meritor / Rockwell 2210-A-6345 Euclid E-4884 Spicer OE M16WKL10-231		
17-574 RH	Meritor / Rockwell 2210-W-3117 Euclid E-1094 Meritor / Rockwell R607001	23 7/16"	2 7/32"
17-575 LH	Meritor / Rockwell 2210-X-3118 Euclid E-1095 Meritor / Rockwell R607002		
17-586 RH	Meritor / Rockwell 2210-Q-6387 Meritor / Rockwell 2210-W-3117 Euclid E-4716 Spicer OE M16WKR10-242 Meritor / Rockwell R607041	24"	2 7/32"
17-587 LH	Meritor / Rockwell 2210-R-6388 Meritor / Rockwell 2210-X-3118 Euclid E-4717 Spicer OE M16WKL10-242 Meritor / Rockwell R607042		

Continued Next Page

Multi-application 16 1/2" Brake

(Continued)

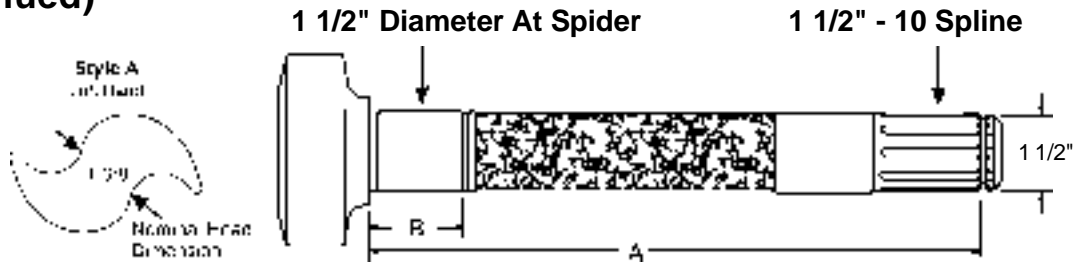

General Information:

- All Cam Lengths ("A" Dim.) Are Measured From Under Cam Head to Beginning of Lock Ring Groove.
- Refer to Camshaft Enclosure Section For Detailed Information.
- Use Camshaft Repair Kit:
 - 43-7032 (Spicer Weld-On Spider with Nylon Bushings)
 - 43-7032A (Spicer Weld-On Spider with Bronze Bushings)
 - 43-7044 (Rockwell RN Series, Contains Complete S-Cam Bracket Assembly)
 - 43-7044A (Rockwell RN Series, Contains S-Cam Bracket Bushings Only)
 - 43-7046 (Rockwell TKL Series, Early Style 2 Piece Spider Bushing)
 - 43-7046A (Rockwell TKL Series, Late Style 1 Piece Spider Bushing)
 - 43-7117 (Weld-On Spider with Bronze Bushings and New Style Bracket Assembly)

Spicer No.	Replaces	A Dim.	B Dim.
17-588 RH	Euclid E-2796 Spicer OE M16WKR10-245 Meritor / Rockwell R607033	24 3/8"	2 7/32"
17-589 LH	Euclid E-2797 Spicer OE M16WKL10-245 Meritor / Rockwell R607034		
17-596 RH	Euclid E-4718 Spicer OE M16WKR10-260 Meritor / Rockwell R607043	25 3/4"	2 7/32"
17-597 LH	Euclid E-4719 Spicer OE M16WKL10-260 Meritor / Rockwell R607044		
17-590 RH	Euclid E-7218 Spicer OE M16WKR10-264 Meritor / Rockwell R607192	26 1/4"	2 7/32"
17-591 LH	Euclid E-7217 Spicer OE M16WKL10-264 Meritor / Rockwell R607191		
17-592 RH	Euclid E-7220 Spicer OE M16WKR10-266 Meritor / Rockwell R607194	26 1/2"	2 7/32"
17-593 LH	Euclid E-7219 Spicer OE M16WKL10-266 Meritor / Rockwell R607193		

Multi-application 16 1/2" Brake

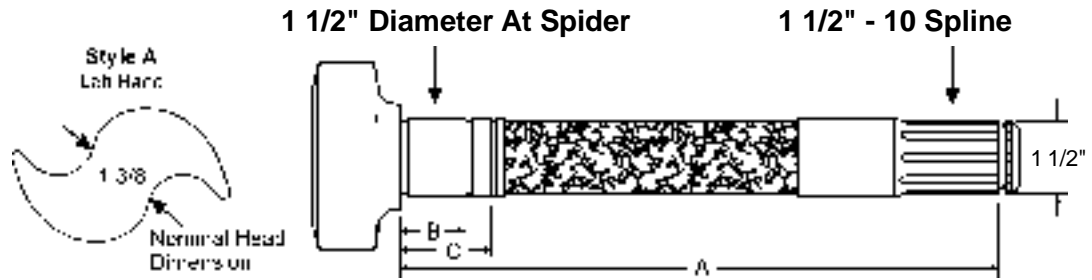

General Information:

- All Cam Lengths ("A" Dim.) Are Measured From Under Cam Head to Beginning of Lock Ring Groove.
- Double Groove
- Refer to Camshaft Enclosure Section For Detailed Information.
- Use Camshaft Repair Kit:
 - 43-7032 (Spicer Weld-On Spider with Nylon Bushings)
 - 43-7032A (Spicer Weld-On Spider with Bronze Bushings)
 - 43-7044 (Rockwell RN Series, Contains Complete S-Cam Bracket Assembly)
 - 43-7044A (Rockwell RN Series, Contains S-Cam Bracket Bushings Only)
 - 43-7046 (Rockwell TKL Series, Early Style 2 Piece Spider Bushing)
 - 43-7046A (Rockwell TKL Series, Late Style 1 Piece Spider Bushing)
 - 43-7117 (Weld-On Spider with Bronze Bushings and New Style Bracket Assembly)

Spicer No.	Replaces	A Dim.	B Dim.	C Dim.
17-568 RH	Euclid E-2794 Spicer OE M16WK116 Meritor / Rockwell R607031	17 3/8"	1 5/8"	2 7/32"
17-569 LH	Euclid E-2795 Spicer OE M16WK117 Meritor / Rockwell R607032			
17-580 RH	Meritor / Rockwell 2210-E-5413 Meritor / Rockwell 2210-M-2483 Euclid E-1424 Euclid E-556	20 3/8"	1 5/8"	2 7/32"
17-581 LH	Meritor / Rockwell 2210-F-5414 Meritor / Rockwell 2210-N-2484 Euclid E-1425 Euclid E-557			
17-598 RH	Eaton B-1691-10 Euclid E-690	22 1/16"	2 7/32"	2 9/16"
17-599 LH	Eaton B-1691-9 Euclid E-691			

Rockwell 12 1/4" Brake

Small S-Head Type Cam

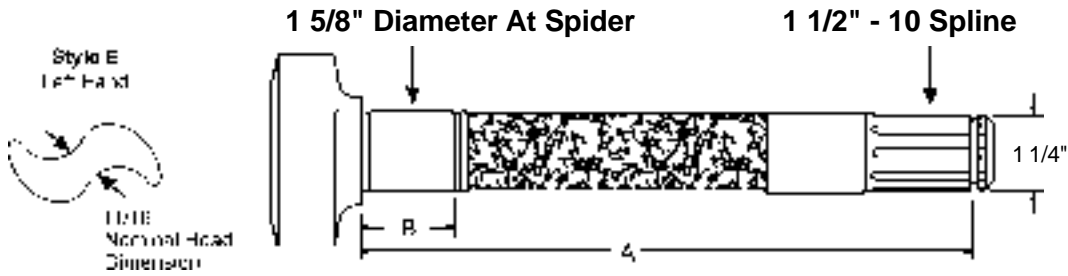

General Information:

- All Cam Lengths ("A" Dim.) Are Measured From Under Cam Head to Beginning of Lock Ring Groove.
- Single Grooved
- Use Camshaft Repair Kit:
 - 43-7037 (2 Piece Spider Bushing, Contains Bushings Only)
 - 43-7037A (2 Piece Spider Bushing, Contains Full Bracket Assembly)
 - 43-7037B (1 Piece Spider Bushing)

Spicer No.	Replaces	A Dim.	B Dim.
17-714 RH	Meritor / Rockwell 2210-G-6013 Meritor / Rockwell 2210-H-6170 Euclid E-4901	20 5/16"	1 3/4"
17-715 LH	Meritor / Rockwell 2210-G-6169 Meritor / Rockwell 2210-H-6014 Euclid E-4900		
17-716 RH		23 5/16"	1 3/4"
17-717 LH			

Rockwell 12 1/4" Brake

Small S-Head Type Cam

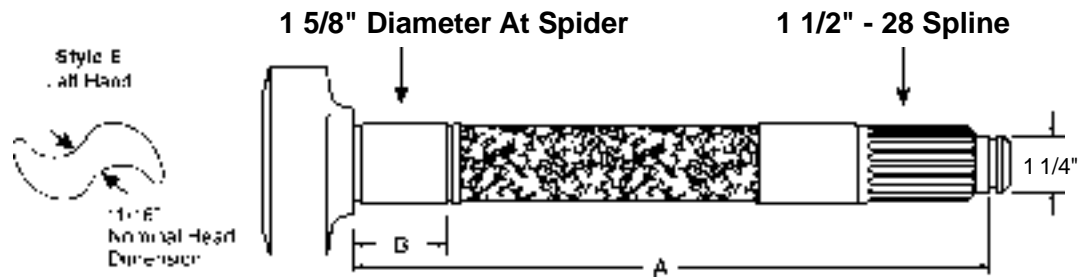

General Information:

- All Cam Lengths ("A" Dim.) Are Measured From Under Cam Head to Beginning of Lock Ring Groove.
- Single Grooved
- Use Camshaft Repair Kit:
 - 43-7037 (2 Piece Spider Bushing, Contains Bushings Only)
 - 43-7037A (2 Piece Spider Bushing, Contains Full Bracket Assembly)
 - 43-7037B (1 Piece Spider Bushing)

Spicer No.	Replaces	A Dim.	B Dim.
17-700 RH	Meritor / Rockwell 2210-D-6166 Meritor / Rockwell 2210-U-5247 Euclid E-3517	20 5/16"	1 3/4"
17-701 LH	Meritor / Rockwell 2210-C-6165 Meritor / Rockwell 2210-T-5246 Euclid E-3516		
17-702 RH	Meritor / Rockwell 2210-F-6168 Meritor / Rockwell 2210-G-5961 Euclid E-9088	23 5/16"	1 3/4"
17-703 LH	Meritor / Rockwell 2210-E-6167 Meritor / Rockwell 2210-F-5960 Euclid E-9087		

Rockwell 16 1/2" Brake

4000-6000 Series Axle with Cast Spider

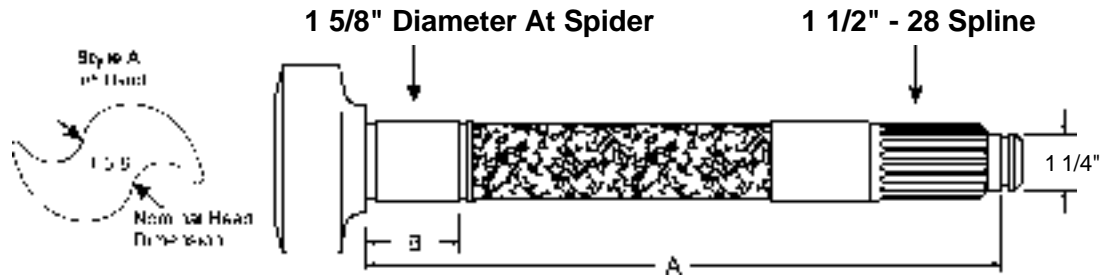

General Information:

- All Cam Lengths ("A" Dim.) Are Measured From Under Cam Head to Beginning of Lock Ring Groove.
- Air Suspension: 17-630, 17-631
- Refer to Camshaft Enclosures Section For Detailed Information.
- Use Camshaft Repair Kit:
 - 43-7037 (2 Piece Spider Bushing, Contains Bushings Only)
 - 43-7037A (2 Piece Spider Bushing, Contains Full Bracket Assembly)
 - 43-7037B (1 Piece Spider Bushing)

Spicer No.	Replaces	A Dim.	B Dim.
17-626 RH	Meritor / Rockwell 2210-L-4328 Euclid E-2442A	17 3/8"	1 23/32"
17-627 LH	Meritor / Rockwell 2210-M-4329 Euclid E-2441A		
17-628 RH	Meritor / Rockwell 2210-Q-4333 Euclid E-2444A	20 1/2"	1 23/32"
17-629 LH	Meritor / Rockwell 2210-R-4334 Euclid E-2443A		
17-630 RH	Meritor / Rockwell 2210-N-4330 Euclid E-2446A	24 1/8"	1 23/32"
17-631 LH	Meritor / Rockwell 2210-P-4332 Euclid E-2445A		

Rockwell 16 1/2" Brake 4000-6000 Series Axle with Fabricated Spider

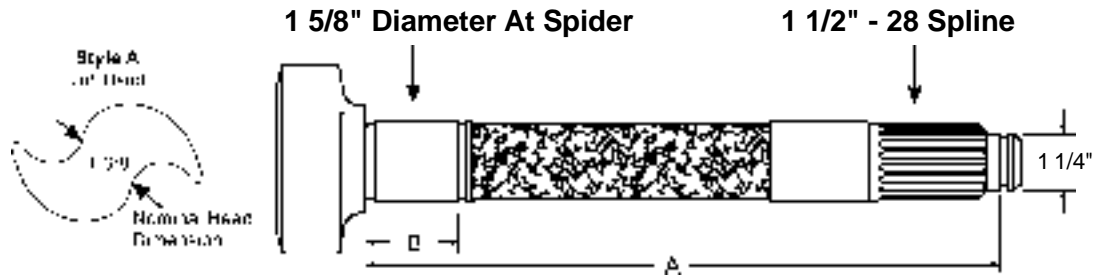

General Information:

- All Cam Lengths ("A" Dim.) Are Measured From Under Cam Head to Beginning of Lock Ring Groove.
- Air Suspension: 17-660, 17-661
- Use Camshaft Repair Kit:
 - 43-7071 (Early Model Fabricated Spiders with Press-In Spider Bushings)
 - 43-7072 (Late Model Fabricated Spiders with Bolt-On Spider Bushings)
 - 43-7072A (Bushing Kit for 43-7072)

Spicer No.	Replaces	A Dim.	B Dim.
17-656 RH	Meritor / Rockwell 2210-U-6469 Meritor / Rockwell 2210-U-6573 Euclid E-9092	17 3/8"	2"
17-657 LH	Meritor / Rockwell 2210-V-6470 Meritor / Rockwell 2210-V-6574 Euclid E-9091		
17-658 RH	Meritor / Rockwell 2210-N-6592 Meritor / Rockwell 2210-Y-6473 Euclid E-9094	20 1/2"	2"
17-659 LH	Meritor / Rockwell 2210-P-6594 Meritor / Rockwell 2210-Z-6474 Euclid E-9093		
17-660 RH	Meritor / Rockwell 2210-W-6471 Meritor / Rockwell 2210-W-6575 Euclid E-6082	24 1/8"	2"
17-661 LH	Meritor / Rockwell 2210-X-6472 Meritor / Rockwell 2210-X-6576 Euclid E-6081		

Rockwell 16 1/2" Brake

4000-6000 Series Axle with "Q Plus" Brake and Cast Spider

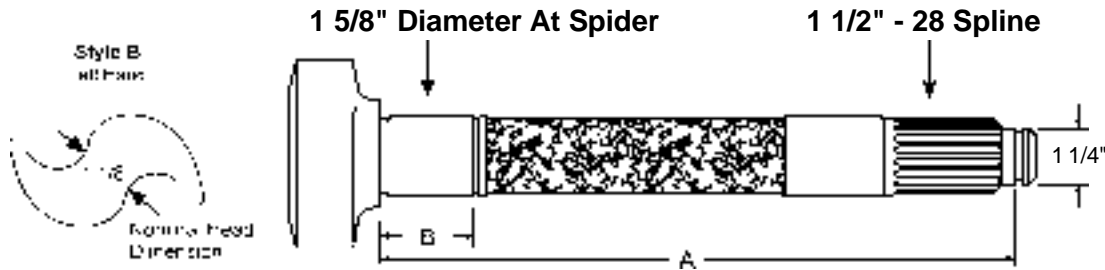

General Information:

- All Cam Lengths ("A" Dim.) Are Measured From Under Cam Head to Beginning of Lock Ring Groove.
- Air Suspension: 17-814, 17-815
- Use Camshaft Repair Kit:
 - 43-7037 (2 Piece Spider Bushing, Contains Bushings Only)
 - 43-7037A (2 Piece Spider Bushing, Contains Full Bracket Assembly)
 - 43-7037B (1 Piece Spider Bushing)

Spicer No.	Replaces	A Dim.	B Dim.
17-810 RH	Meritor / Rockwell 2210-L-4328 Meritor / Rockwell 2210-Q-8155	17 3/8"	1 23/32"
17-811 LH	Meritor / Rockwell 2210-M-4329 Meritor / Rockwell 2210-R-8156		
17-812 RH	Meritor / Rockwell 2210-Q-4333 Meritor / Rockwell 2210-S-8157	20 1/2"	1 23/32"
17-813 LH	Meritor / Rockwell 2210-R-4334 Meritor / Rockwell 2210-T-8158		
17-814 RH	Meritor / Rockwell 2210-N-4300 Meritor / Rockwell 2210-U-8159	24 1/8"	1 23/32"
17-815 LH	Meritor / Rockwell 2210-P-4332 Meritor / Rockwell 2210-V-8160		

Rockwell 16 1/2" Brake

4000-6000 Series Axle with Cast Spider

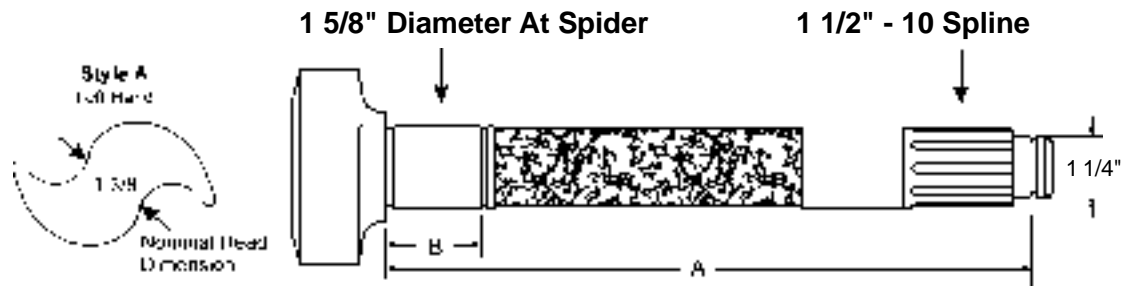

General Information:

- All Cam Lengths ("A" Dim.) Are Measured From Under Cam Head to Beginning of Lock Ring Groove.
- Air Suspension: 17-642, 17-643
- Refer to Camshaft Enclosures Section For Detailed Information.
- Use Camshaft Repair Kit:
 - 43-7037 (2 Piece Spider Bushing, Contains Bushings Only)
 - 43-7037A (2 Piece Spider Bushing, Contains Full Bracket Assembly)
 - 43-7037B (1 Piece Spider Bushing)

Spicer No.	Replaces	A Dim.	B Dim.
17-640 RH	Meritor / Rockwell 2210-R-4178 Euclid E-2448	17 3/8"	1 23/32"
17-641 LH	Meritor / Rockwell 2210-S-4179 Euclid E-2447		
17-632 RH	Meritor / Rockwell 2210-V-4182 Euclid E-2450	20 15/32"	1 23/32"
17-633 LH	Meritor / Rockwell 2210-W-4183 Euclid E-2449		
17-642 RH	Meritor / Rockwell 2210-T-4180 Euclid E-2452	24 1/8"	1 23/32"
17-643 LH	Meritor / Rockwell 2210-U-4181 Euclid E-2451		

Rockwell 16 1/2" Brake

"Q Plus" Brake with Forged or Fabricated Spider

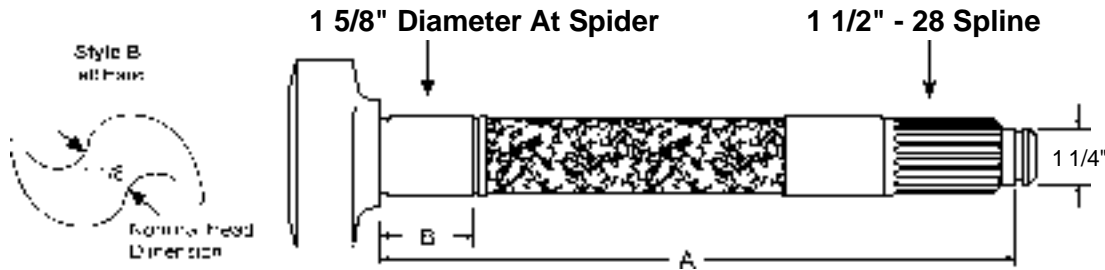

General Information:

- All Cam Lengths ("A" Dim.) Are Measured From Under Cam Head to Beginning of Lock Ring Groove.
- Air Suspension: 17-724, 17-725
- Use Camshaft Repair Kit:
 - 43-7071 (Early Model Fabricated Spiders with Press-In Spider Bushings)
 - 43-7072 (Late Model Fabricated Spiders with Bolt-On Spider Bushings)
 - 43-7072A (Bushing Kit for 43-7072)

Spicer No.	Replaces	A Dim.	B Dim.
17-720 RH	Meritor / Rockwell 2210-B-6866 Euclid E-5507	17 5/16"	2"
17-721 LH	Meritor / Rockwell 2210-C-6867 Euclid E-5506		
17-722 RH	Meritor / Rockwell 2210-F-6870 Euclid E-5509	20 7/16"	2"
17-723 LH	Meritor / Rockwell 2210-G-6871 Euclid E-5508		
17-724 RH	Meritor / Rockwell 2210-D-6868 Euclid E-5511	24 1/16"	2"
17-725 LH	Meritor / Rockwell 2210-E-6869 Euclid E-5510		

For Spicer 12 1/4" Brake S-Camshafts

New Style Cam (1 1/2" Roller) Roller Part Number 32-1427

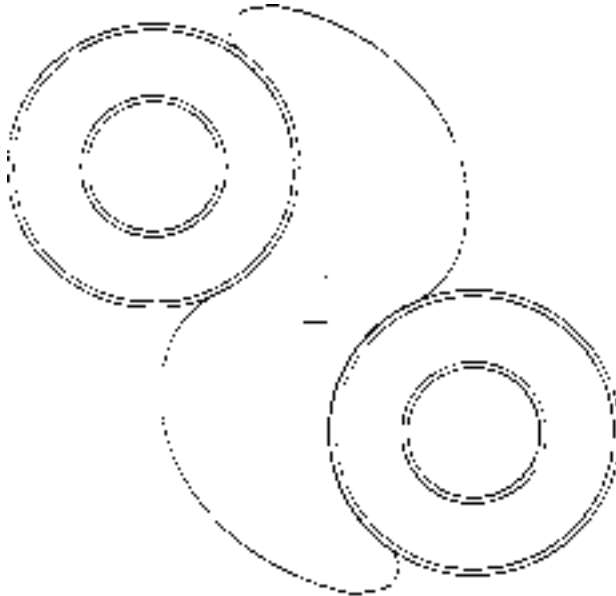

Head Marking: 0794L & 0794R
(as of July, 1994)

Old Style Cam (1 1/4" Roller) Roller Part Number 32-1428

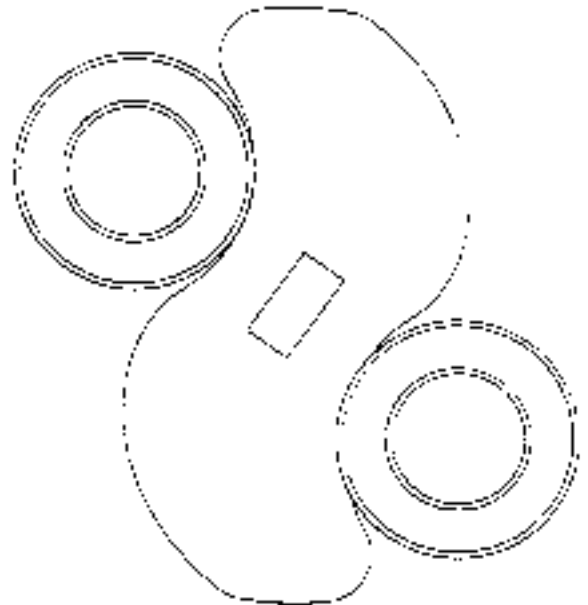

Head Marking: M12L & M12R

The old style cam has been discontinued for all new production 12 1/4" brake assemblies. Effective August, 1994, only new-style cams are available for service.

IMPORTANT SERVICE GUIDELINES

Please note the following guidelines when using the new-style S-cam in service:

This design change affects only the S-cam and rollers. The use of the new-style S-cam requires the use of a 1.50" diameter roller. Check to be sure the roller being used is the proper diameter.

NOTICE: The new S-cam should **NOT** be used in conjunction with an old-style S-cam on the same trailer axle. New-style S-cams **MUST** be used in both sets of brake assemblies on the trailer axle. The rate of brake application is different from the old-style and new-style S-cams. If the two styles of S-cams are mixed on one trailer axle, one brake may apply sooner than the other, which could result in premature wear and uneven application of brakes which requires prompt service.

NOTICE: The new-style S-cam should **NOT** be used with cast 12 1/4" brake shoes. The cast brake shoes require the use of the old-style S-cam. S-cam service on cast brake shoes requires changing the brake shoes to fabricated tapered lining brake shoes using the new-style S-cam. Failure to change the brake shoe when using the new-style S-cam will result in a failure of the S-cam to function properly and could also cause uneven application of brakes which requires prompt service.

Spicer 12 1/4" Brake

(Used On Axles Manufactured After February, 1996)

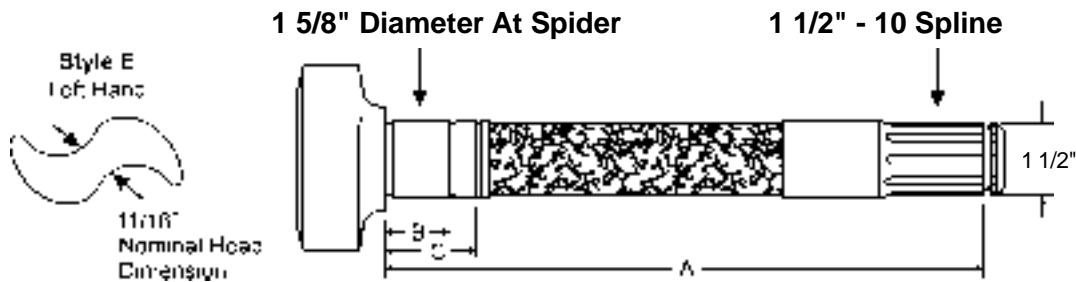

General Information:

- All Cam Lengths ("A" Dim.) Are Measured From Under Cam Head to Beginning of Lock Ring Groove.
- Double Grooved, New Style S-Cam
- Use Camshaft Repair Kit: 43-7118

Spicer No.	Replaces	A Dim.	B Dim.	C Dim.
17-960 RH	Spicer OE M12WKR15-163	16 1/8"	2 7/32"	2 21/32"
17-961 LH	Spicer OE M12WKL15-163			
17-962 RH	Spicer OE M12WKR15-175	17 3/8"	2 7/32"	2 21/32"
17-963 LH	Spicer OE M12WKL15-175			
17-964 RH	Spicer OE M12WKR15-182	18"	2 7/32"	2 21/32"
17-965 LH	Spicer OE M12WKL15-182			
17-966 RH	Spicer OE M12WKR15-191	18 7/8"	2 7/32"	2 21/32"
17-967 LH	Spicer OE M12WKL15-191			
17-968 RH	Spicer OE M12WKR15-202	20"	2 7/32"	2 21/32"
17-969 LH	Spicer OE M12WKL15-202			
17-970 RH	Spicer OE M12WKR15-204	20 5/16"	2 7/32"	2 21/32"
17-971 LH	Spicer OE M12WKL15-204			
17-972 RH	Spicer OE M12WKR15-206	20 1/2"	2 7/32"	2 21/32"
17-973 LH	Spicer OE M12WKL15-206			
17-974 RH	Spicer OE M12WKR15-213	21 1/8"	2 7/32"	2 21/32"
17-975 LH	Spicer OE M12WKL15-213			
17-976 RH	Spicer OE M12WKR15-214	21 1/4"	2 7/32"	2 21/32"
17-977 LH	Spicer OE M12WKL15-214			
17-978 RH	Spicer OE M12WKR15-222	22"	2 7/32"	2 21/32"
17-979 LH	Spicer OE M12WKL15-222			
17-980 RH	Spicer OE M12WKR15-225	22 5/16"	2 7/32"	2 21/32"
17-981 LH	Spicer OE M12WKL15-225			
17-996 RH	Spicer OE M12WKR15-233	23 1/8"	2 7/32"	2 21/32"
17-997 LH	Spicer OE M12WKL15-233			

Continued Next Page

Spicer 12 1/4" Brake

(Used On Axles Manufactured After February, 1996)

(Continued)

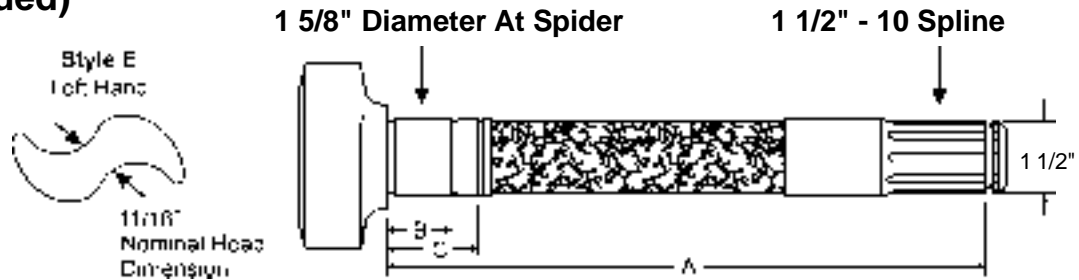

General Information:

- All Cam Lengths ("A" Dim.) Are Measured From Under Cam Head to Beginning of Lock Ring Groove.
- Double Grooved, New Style S-Cam
- Use Camshaft Repair Kit: 43-7118

Spicer No.	Replaces	A Dim.	B Dim.	C Dim.
17-982 RH	Spicer OE M12WKR15-234	23 1/4"	2 7/32"	2 21/32"
17-983 LH	Spicer OE M12WKL15-234			
17-984 RH	Spicer OE M12WKR15-236	23 1/2"	2 7/32"	2 21/32"
17-985 LH	Spicer OE M12WKL15-236			
17-986 RH	Spicer OE M12WKR15-241	23 7/8"	2 7/32"	2 21/32"
17-987 LH	Spicer OE M12WKL15-241			
17-988 RH	Spicer OE M12WKR15-247	24 5/8"	2 7/32"	2 21/32"
17-989 LH	Spicer OE M12WKL15-247			
17-990 RH	Spicer OE M12WKR15-254	25 1/4"	2 7/32"	2 21/32"
17-991 LH	Spicer OE M12WKL15-254			
17-992 RH	Spicer OE M12WKR15-264	26 1/4"	2 7/32"	2 21/32"
17-993 LH	Spicer OE M12WKL15-264			
17-994 RH	Spicer OE M12WKR15-266	26 1/2"	2 7/32"	2 21/32"
17-995 LH	Spicer OE M12WKL15-266			

Spicer 12 1/4" Brake

(Used On Axles Manufactured After February, 1996)

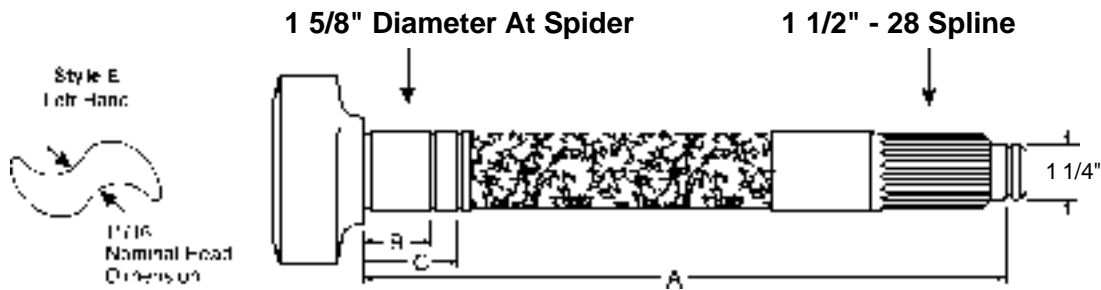

General Information:

- All Cam Lengths ("A" Dim.) Are Measured From Under Cam Head to Beginning of Lock Ring Groove.
- Double Grooved, New Style S-Cam
- Use Camshaft Repair Kit: 43-7118

Spicer No.	Replaces	A Dim.	B Dim.	C Dim.
17-400 RH	Spicer OE M12WKR25-163	16 1/8"	2 7/32"	2 21/32"
17-401 LH	Spicer OE M12WKL25-163			
17-404 RH	Spicer OE M12WKR25-182	18"	2 7/32"	2 21/32"
17-405 LH	Spicer OE M12WKL25-182			
17-406 RH	Spicer OE M12WKR25-191	18 7/8"	2 7/32"	2 21/32"
17-407 LH	Spicer OE M12WKL25-191			
17-408 RH	Spicer OE M12WKR25-205	20 3/8"	2 7/32"	2 21/32"
17-409 LH	Spicer OE M12WKL25-205			
17-402 RH	Euclid E-10902 Spicer OE M12WKR25-206 Meritor / Rockwell R607270	20 1/2"	2 7/32"	2 21/32"
17-403 LH	Euclid E-10901 Spicer OE M12WKL25-206 Meritor / Rockwell R607269			
17-410 RH	Spicer OE M12WKR25-213	21 1/8"	2 7/32"	2 21/32"
17-411 LH	Spicer OE M12WKL25-213			
17-414 RH	Euclid E-10904 Spicer OE M12WKR25-214 Meritor / Rockwell R607272	21 1/4"	2 7/32"	2 21/32"
17-415 LH	Euclid E-10903 Spicer OE M12WKL25-214 Meritor / Rockwell R607271			
17-412 RH	Spicer OE M12WKR25-222	22"	2 7/32"	2 21/32"
17-413 LH	Spicer OE M12WKL25-222			

Continued Next Page

Spicer 12 1/4" Brake

(Used On Axles Manufactured After February, 1996)

(Continued)

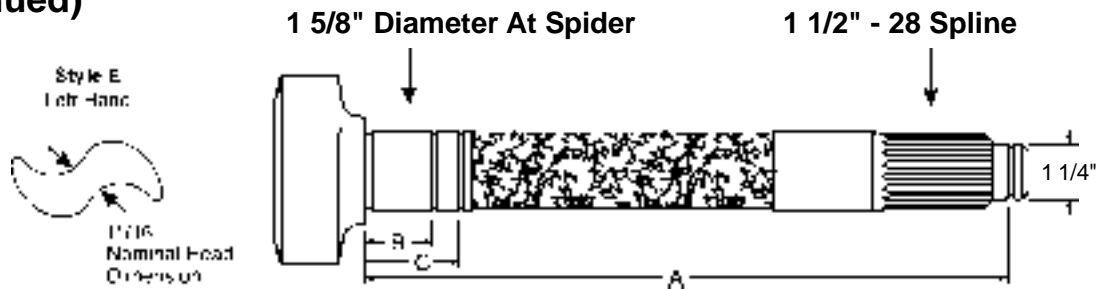

General Information:

- All Cam Lengths ("A" Dim.) Are Measured From Under Cam Head to Beginning of Lock Ring Groove.
- Double Grooved, New Style S-Cam
- Use Camshaft Repair Kit: 43-7118

Spicer No.	Replaces	A Dim.	B Dim.	C Dim.
17-416 RH	Euclid E-10906 Spicer OE M12WKR25-233 Meritor / Rockwell R607274	23 1/8"	2 7/32"	2 21/32"
17-417 LH	Euclid E-10905 Spicer OE M12WKL25-233 Meritor / Rockwell R607273			
17-420 RH	Spicer OE M12WKR25-234	23 1/4"	2 7/32"	2 21/32"
17-421 LH	Spicer OE M12WKL25-234			
17-418 RH	Euclid E-10908 Spicer OE M12WKR25-241 Meritor / Rockwell R607276	23 7/8"	2 7/32"	2 21/32"
17-419 LH	Euclid E-10907 Spicer OE M12WKL25-241 Meritor / Rockwell R607275			
17-424 RH	Spicer OE M12WKR25-264	26 1/4"	2 7/32"	2 21/32"
17-425 LH	Spicer OE M12WKL25-264			

Spicer 12 1/4" Brake

(Used On Axles Manufactured After July, 1994)

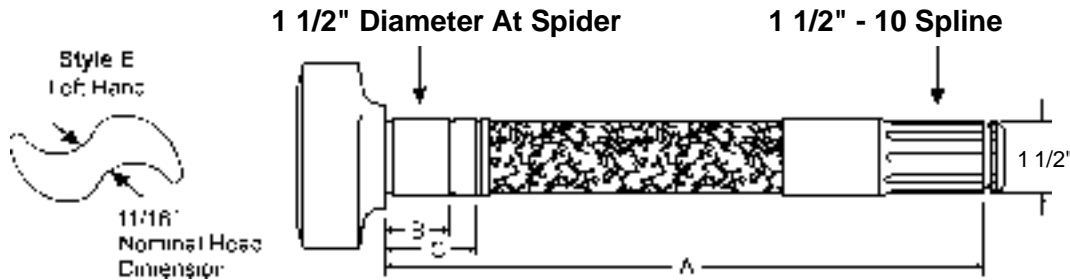

General Information:

- All Cam Lengths ("A" Dim.) Are Measured From Under Cam Head to Beginning of Lock Ring Groove.
- Double Grooved
- Use Camshaft Repair Kit:
 - 43-7031 (Weld-On Spider with Bronze Bushing)
 - 43-7033 (For New Style 4-Bolt S-Cam Bracket, After 1990)
 - 43-7117 (Weld-On Spider with Bronze Bushings and New Style Bracket Assembly)

Spicer No.	Replaces	A Dim.	B Dim.	C Dim.
17-734 RH	Euclid E-9264 Spicer OE M12WKR10-163 Meritor / Rockwell R607202	16 1/8"	2 7/32"	2 21/32"
17-735 LH	Euclid E-9263 Spicer OE M12WKL10-163 Meritor / Rockwell R607201			
17-736 RH	Euclid E-9752 Spicer OE M12WKR10-175 Meritor / Rockwell R607246	17 3/8"	2 7/32"	2 21/32"
17-737 LH	Euclid E-9751 Spicer OE M12WKL10-175 Meritor / Rockwell R607245			
17-740 RH	Euclid E-9750 Spicer OE M12WKR10-182 Meritor / Rockwell R607265	18"	2 7/32"	2 21/32"
17-741 LH	Euclid E-9749 Spicer OE M12WKL10-182 Meritor / Rockwell R607266			
17-744 RH	Euclid E-9266 Spicer OE M12WKR10-191 Meritor / Rockwell R607204	18 7/8"	2 7/32"	2 21/32"
17-745 LH	Euclid E-9265 Spicer OE M12WKL10-191 Meritor / Rockwell R607203			
17-746 RH	Spicer OE M12WKR10-202	20"	2 7/32"	2 21/32"
17-747 LH	Spicer OE M12WKL10-202			
17-748 RH	Spicer OE M12WKR10-204	20 5/16"	2 7/32"	2 21/32"
17-749 LH	Spicer OE M12WKL10-204			

NOTE: Refer to 12 1/4" brake service information on page 89.

Continued Next Page

Spicer 12 1/4" Brake
 (Used On Axles Manufactured After July, 1994)

(Continued)

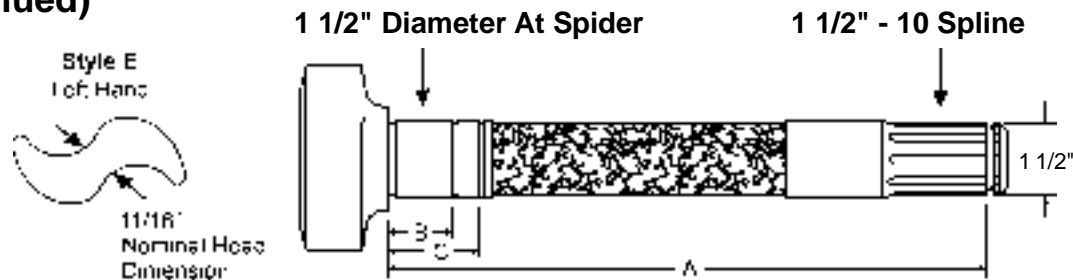

General Information:

- All Cam Lengths ("A" Dim.) Are Measured From Under Cam Head to Beginning of Lock Ring Groove.
- Double Grooved
- Use Camshaft Repair Kit:
 - 43-7031 (Weld-On Spider with Bronze Bushing)
 - 43-7033 (For New Style 4-Bolt S-Cam Bracket, After 1990)
 - 43-7117 (Weld-On Spider with Bronze Bushings and New Style Bracket Assembly)

Spicer No.	Replaces	A Dim.	B Dim.	C Dim.
17-750 RH	Euclid E-9268 Spicer OE M12WKR10-206 Meritor / Rockwell R607206	20 1/2"	2 7/32"	2 21/32"
17-751 LH	Euclid E-9267 Spicer OE M12WKL10-206 Meritor / Rockwell R607205			
17-752 RH	Spicer OE M12WKR10-213	21 1/8"	2 7/32"	2 21/32"
17-753 LH	Spicer OE M12WKL10-213			
17-754 RH	Euclid E-9270 Spicer OE M12WKR10-214 Meritor / Rockwell R607208	21 1/4"	2 7/32"	2 21/32"
17-755 LH	Euclid E-9269 Spicer OE M12WKL10-214 Meritor / Rockwell R607207			
17-756 RH	Euclid E-9272 Spicer OE M12WKR10-222 Meritor / Rockwell R607210	22"	2 7/32"	2 21/32"
17-757 LH	Euclid E-9271 Spicer OE M12WKL10-222 Meritor / Rockwell R607209			
17-758 RH	Spicer OE M12WKR10-225	22 5/16"	2 7/32"	2 21/32"
17-759 LH	Spicer OE M12WKL10-225			
17-738 RH	Euclid E-9274 Spicer OE M12WKR10-233	23 1/8"	2 7/32"	2 21/32"
17-739 LH	Euclid E-9273 Spicer OE M12WKL10-233			

NOTE: Refer to 12 1/4" brake service information on page 89.

Continued Next Page

Spicer 12 1/4" Brake

(Used On Axles Manufactured After July, 1994)

(Continued)

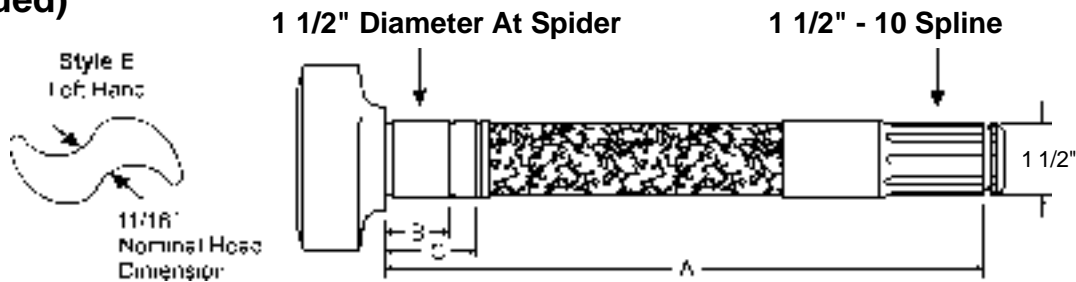

General Information:

- All Cam Lengths ("A" Dim.) Are Measured From Under Cam Head to Beginning of Lock Ring Groove.
- Double Grooved
- Use Camshaft Repair Kit:
 - 43-7031 (Weld-On Spider with Bronze Bushing)
 - 43-7033 (For New Style 4-Bolt S-Cam Bracket, After 1990)
 - 43-7117 (Weld-On Spider with Bronze Bushings and New Style Bracket Assembly)

Spicer No.	Replaces	A Dim.	B Dim.	C Dim.
17-760 RH	Spicer OE M12WKR10-234 Meritor / Rockwell R607212	23 1/4"	2 7/32"	2 21/32"
17-761 LH	Spicer OE M12WKL10-234 Meritor / Rockwell R607211			
17-762 RH	Euclid E-9276 Spicer OE M12WKR10-236 Meritor / Rockwell R607214	23 1/2"	2 7/32"	2 21/32"
17-763 LH	Euclid E-9275 Spicer OE M12WKL10-236 Meritor / Rockwell R607213			
17-764 RH	Euclid E-9278 Spicer OE M12WKR10-241 Meritor / Rockwell R607216	23 7/8"	2 7/32"	2 21/32"
17-765 LH	Euclid E-9277 Spicer OE M12WKL10-241 Meritor / Rockwell R607215			
17-766 RH	Spicer OE M12WKR10-247	24 5/8"	2 7/32"	2 21/32"
17-767 LH	Spicer OE M12WKL10-247			
17-768 RH	Spicer OE M12WKR10-254	25 1/4"	2 7/32"	2 21/32"
17-769 LH	Spicer OE M12WKL10-254			
17-770 RH	Euclid E-9280 Spicer OE M12WKR10-264 Meritor / Rockwell R607218	26 1/4"	2 7/32"	2 21/32"
17-771 LH	Euclid E-9279 Spicer OE M12WKL10-264 Meritor / Rockwell R607217			
17-772 RH	Spicer OE M12WKR10-266	26 1/2"	2 7/32"	2 21/32"
17-773 LH	Spicer OE M12WKL10-266			

NOTE: Refer to 12 1/4" brake service information on page 89.

Spicer 12 1/4" Brake
(Used On Axles Manufactured After July, 1994)

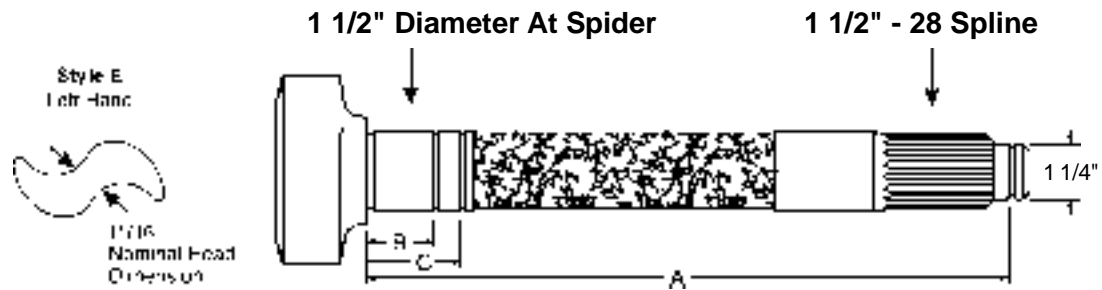

General Information:

- All Cam Lengths ("A" Dim.) Are Measured From Under Cam Head to Beginning of Lock Ring Groove.
- Double Grooved, New Style S-Cam
- Use Camshaft Repair Kit:
 - 43-7031 (Weld-On Spider with Bronze Bushing)
 - 43-7033 (For New Style 4-Bolt S-Cam Bracket, After 1990)
 - 43-7117 (Weld-On Spider with Bronze Bushings and New Style Bracket Assembly)

Spicer No.	Replaces	A Dim.	B Dim.	C Dim.
17-784 RH	Spicer OE M12WKR20-163	16 1/8"	2 7/32"	2 21/32"
17-785 LH	Spicer OE M12WKL20-163			
17-788 RH	Spicer OE M12WKR20-182	18"	2 7/32"	2 21/32"
17-789 LH	Spicer OE M12WKL20-182			
17-792 RH	Spicer OE M12WKR20-191	18 7/8"	2 7/32"	2 21/32"
17-793 LH	Spicer OE M12WKL20-191			
17-794 RH	Euclid E-9754 Spicer OE M12WKR20-205 Meritor / Rockwell R607248	20 3/8"	2 7/32"	2 21/32"
17-795 LH	Euclid E-9753 Spicer OE M12WKL20-205 Meritor / Rockwell R607247			
17-780 RH	Spicer OE M12WKR20-213	21 1/8"	2 7/32"	2 21/32"
17-781 LH	Spicer OE M12WKL20-213			
17-786 RH	Euclid E-9756 Spicer OE M12WKR20-214 Meritor / Rockwell R607250	21 1/4"	2 7/32"	2 21/32"
17-787 LH	Euclid E-9755 Spicer OE M12WKL20-214 Meritor / Rockwell R607249			
17-796 RH	Euclid E-9758 Spicer OE M12WKR20-222 Meritor / Rockwell R607252	22"	2 7/32"	2 21/32"
17-797 LH	Euclid E-9757 Spicer OE M12WKL20-222 Meritor / Rockwell R607251			

NOTE: Refer to 12 1/4" brake service information on page 89.

Continued Next Page

Spicer 12 1/4" Brake

(Used On Axles Manufactured After July, 1994)

(Continued)

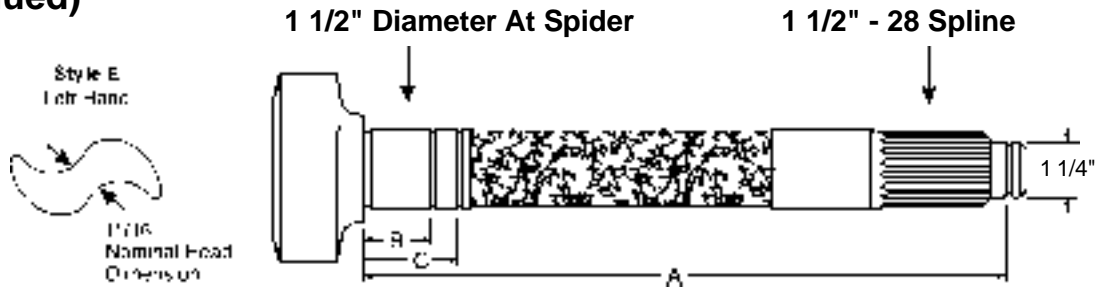

General Information:

- All Cam Lengths ("A" Dim.) Are Measured From Under Cam Head to Beginning of Lock Ring Groove.
- Double Grooved, New Style S-Cam
- Use Camshaft Repair Kit:
 - 43-7031 (Weld-On Spider with Bronze Bushing)
 - 43-7033 (For New Style 4-Bolt S-Cam Bracket, After 1990)
 - 43-7117 (Weld-On Spider with Bronze Bushings and New Style Bracket Assembly)

Spicer No.	Replaces	A Dim.	B Dim.	C Dim.
17-782 RH	Euclid E-9760 Spicer OE M12WKR20-233 Meritor / Rockwell R607254	23 1/8"	2 7/32"	2 21/32"
17-783 LH	Euclid E-9759 Spicer OE M12WKL20-233 Meritor / Rockwell R607253			
17-778 RH	Spicer OE M12WKR20-234	23 1/4"	2 7/32"	2 21/32"
17-779 LH	Spicer OE M12WKL20-234			
17-798 RH	Spicer OE M12WKR20-241	23 7/8"	2 7/32"	2 21/32"
17-799 LH	Spicer OE M12WKL20-241			
17-804 RH	Spicer OE M12WKR20-264	26 1/4"	2 7/32"	2 21/32"
17-805 LH	Spicer OE M12WKL20-264			

NOTE: Refer to 12 1/4" brake service information on page 89.

Spicer 12 1/4" Brake
(Used On Axles Manufactured Before August, 1994)

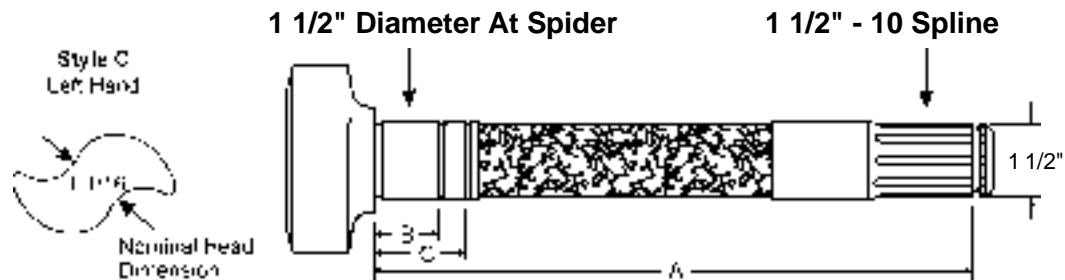

General Information:

- All Cam Lengths ("A" Dim.) Are Measured From Under Cam Head to Beginning of Lock Ring Groove.
- Double Grooved
- Refer to Camshaft Enclosures Section For Detailed Information.
- Use Camshaft Repair Kit:
 - 43-7031 (Weld-On Spider with Bronze Bushing)
 - 43-7033 (For New Style 4-Bolt S-Cam Bracket, After 1990)
 - 43-7117 (Weld-On Spider with Bronze Bushings and New Style Bracket Assembly)

Spicer No.	Replaces	A Dim.	B Dim.	C Dim.
17-678 RH	Spicer OE M12WKR10-182	18"	2 7/32"	2 21/32"
17-679 LH	Spicer OE M12WKL10-182			
17-676 RH	Euclid E-9744 Spicer OE M12WKR10-191 Meritor / Rockwell R607240	18 7/8"	2 7/32"	2 21/32"
17-677 LH	Euclid E-9743 Spicer OE M12WKL10-191 Meritor / Rockwell R607239			
17-688 RH	Spicer OE M12WKR10-202	20"	2 7/32"	2 21/32"
17-689 LH	Spicer OE M12WKL10-202			
17-680 RH	Euclid E-5097 Spicer OE M12WKR10-205 Meritor / Rockwell R607166	20 1/2"	2 7/32"	2 21/32"
17-681 LH	Euclid E-5096 Spicer OE M12WKL10-205 Meritor / Rockwell R607165			
17-684 RH	Euclid E-1410 Spicer OE M12WKR10-213 Meritor / Rockwell R607005	21 1/8"	2 7/32"	2 21/32"
17-685 LH	Euclid E-1411 Spicer OE M12WKL10-213 Meritor / Rockwell R607006			
17-686 RH	Spicer OE M12WKR10-214	21 1/4"	2 7/32"	2 21/32"
17-687 LH	Spicer OE M12WKL10-214			

NOTE: Refer to 12 1/4" brake service information on page 89.

Continued Next Page

Spicer 12 1/4" Brake

(Used On Axles Manufactured Before August, 1994)

(Continued)

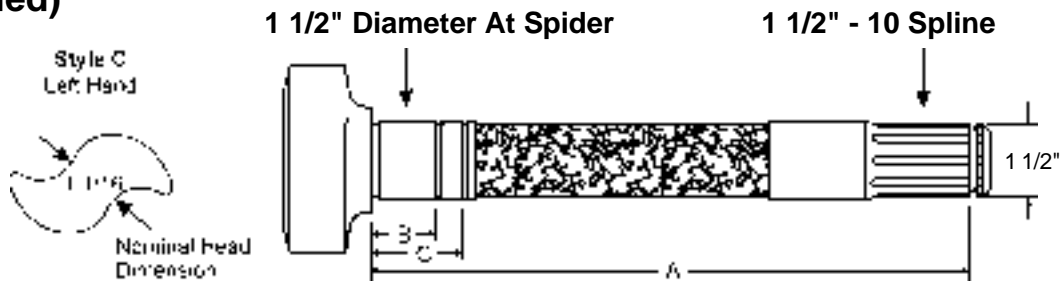

General Information:

- All Cam Lengths ("A" Dim.) Are Measured From Under Cam Head to Beginning of Lock Ring Groove.
- Double Grooved
- Refer to Camshaft Enclosures Section For Detailed Information.
- Use Camshaft Repair Kit:
 - 43-7031 (Weld-On Spider with Bronze Bushing)
 - 43-7033 (For New Style 4-Bolt S-Cam Bracket, After 1990)
 - 43-7117 (Weld-On Spider with Bronze Bushings and New Style Bracket Assembly)

Spicer No.	Replaces	A Dim.	B Dim.	C Dim.
17-692 RH	Euclid E-9746 Spicer OE M12WKR10-222 Meritor / Rockwell R607242	22"	2 7/32"	2 21/32"
17-693 LH	Euclid E-9745 Spicer OE M12WKL10-222 Meritor / Rockwell R607241			
17-690 RH	Euclid E-1422 Spicer OE M12WKR10-234 Meritor / Rockwell R607009	23 1/4"	2 7/32"	2 21/32"
17-691 LH	Euclid E-1423 Spicer OE M12WKL10-234 Meritor / Rockwell R607010			
17-710 RH	Spicer OE M12WK100-18 Spicer OE M12WKR10-236	23 1/2"	2 7/32"	2 21/32"
17-711 LH	Spicer OE M12WK101-18 Spicer OE M12WKL10-236			
17-694 RH	Euclid E-1420 Spicer OE M12WKR10-241 Meritor / Rockwell R607007	23 7/8"	2 7/32"	2 21/32"
17-695 LH	Euclid E-1421 Spicer OE M12WKL10-241 Meritor / Rockwell R607008			

NOTE: Refer to 12 1/4" brake service information on page 89.

Continued Next Page

Spicer 12 1/4" Brake

(Used On Axles Manufactured Before August, 1994)

(Continued)

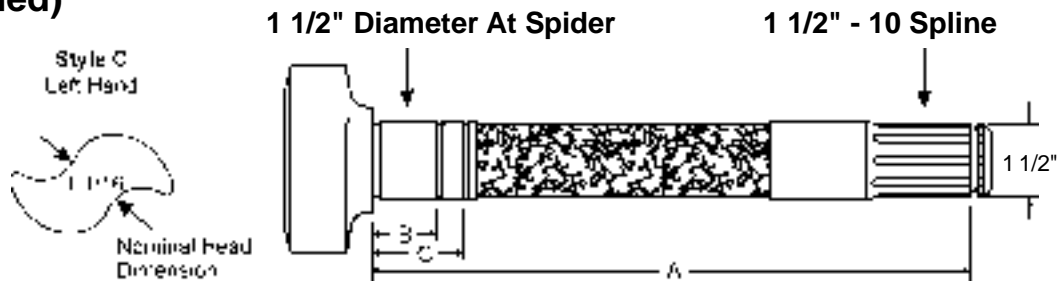

General Information:

- All Cam Lengths ("A" Dim.) Are Measured From Under Cam Head to Beginning of Lock Ring Groove.
- Double Grooved
- Refer to Camshaft Enclosures Section For Detailed Information.
- Use Camshaft Repair Kit:
 - 43-7031 (Weld-On Spider with Bronze Bushing)
 - 43-7033 (For New Style 4-Bolt S-Cam Bracket, After 1990)
 - 43-7117 (Weld-On Spider with Bronze Bushings and New Style Bracket Assembly)

Spicer No.	Replaces	A Dim.	B Dim.	C Dim.
17-648 RH	Std. Forge 202103-247R Euclid E-2792 Spicer OE M12WKR10-247 Meritor / Rockwell R607168	24 5/8"	2 7/32"	2 21/32"
17-649 LH	Std. Forge 202103-247L Euclid E-2793 Spicer OE M12WKL10-247 Meritor / Rockwell R607167			
17-706 RH	Std. Forge 202103-253R Spicer OE M12WKR10-253	25 1/4"	2 7/32"	2 21/32"
17-707 LH	Std. Forge 202103-253L Spicer OE M12WKL10-253			
17-708 RH	Spicer OE M12WKR10-264	26 1/4"	2 7/32"	2 21/32"
17-709 LH	Spicer OE M12WKL10-264			
17-696 RH	Euclid E-9748 Spicer OE M12WKR10-266 Meritor / Rockwell R607244	26 1/2"	2 7/32"	2 21/32"
17-697 LH	Euclid E-9747 Spicer OE M12WKL10-266 Meritor / Rockwell R607243			

NOTE: Refer to 12 1/4" brake service information on page 89.

Spicer 12 1/4" Brake

(Used On Axles Manufactured Before August, 1994)

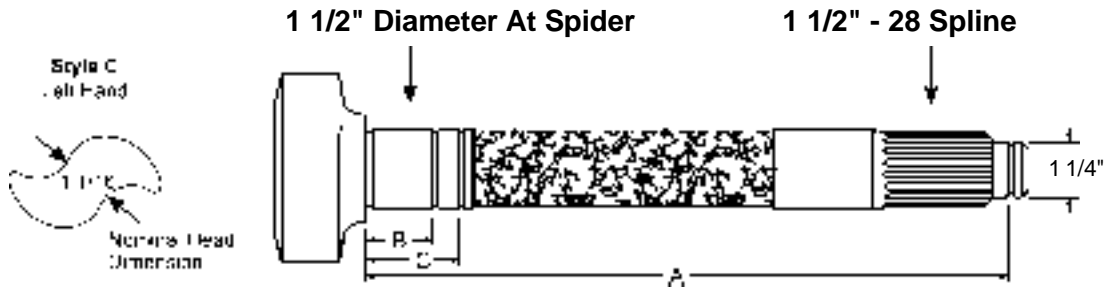

General Information:

- All Cam Lengths ("A" Dim.) Are Measured From Under Cam Head to Beginning of Lock Ring Groove.
- Double Grooved, Old Style Head.
- Use Camshaft Repair Kit:
 - 43-7031 (Weld-On Spider with Bronze Bushing)
 - 43-7033 (For New Style 4-Bolt S-Cam Bracket, After 1990)
 - 43-7117 (Weld-On Spider with Bronze Bushings and New Style Bracket Assembly)

Spicer No.	Replaces	A Dim.	B Dim.	C Dim.
17-438 RH	Spicer OE M12WKR20-213	21 1/8"	2 7/32"	2 21/32"
17-439 LH	Spicer OE M12WKL20-213			
17-442 RH	Spicer OE M12WKR20-233	23 1/8"	2 7/32"	2 21/32"
17-443 LH	Spicer OE M12WKL20-233			

NOTE: Refer to 12 1/4" brake service information on page 89.

Spicer 16 1/2" Brake

Standard S-Head Cam

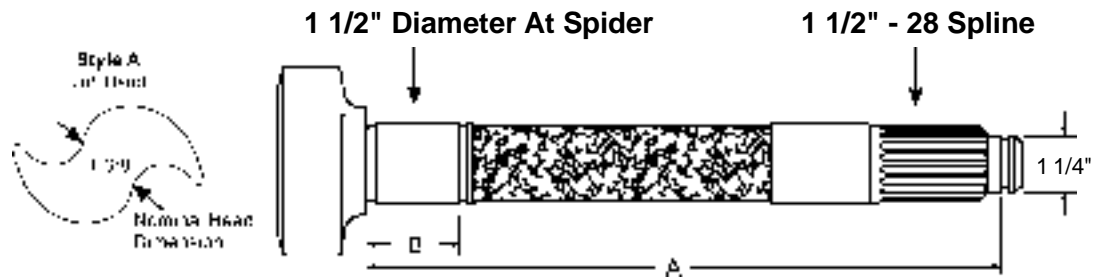

General Information:

- All Cam Lengths ("A" Dim.) Are Measured From Under Cam Head to Beginning of Lock Ring Groove.
- When Replacing Standard "S" Head With High Rise "S" , We Recommend They be Replaced in Pairs.
- Refer to Camshaft Enclosures Section For Detailed Information.
- Use Camshaft Repair Kit:
 - 43-7032 (Weld-On Spider with Nylon Bushings)
 - 43-7032A (Weld-On Spider with Bronze Bushings)
 - 43-7117 (Weld-On Spider with Bronze Bushings and New Style Bracket Assembly)

Spicer No.	Replaces	A Dim.	B Dim.
17-478 RH	Euclid E-9726 Spicer OE M16WK105-10 Meritor / Rockwell R607222	17 3/8"	2 7/32"
17-479 LH	Euclid E-9725 Spicer OE M16WK104-10 Meritor / Rockwell R607221		
17-480 RH	Euclid E-3855 Spicer OE M16WK105-17 Meritor / Rockwell R607170	20 3/8"	2 7/32"
17-481 LH	Euclid E-3854 Spicer OE M16WK104-17 Meritor / Rockwell R607169		
17-484 RH	Euclid E-6885 Spicer OE M16WK105-23 Meritor / Rockwell R607190	22 7/8"	2 7/32"
17-485 LH	Euclid E-6884 Spicer OE M16WK104-23 Meritor / Rockwell R607189		
17-482 RH	Euclid E-3857 Spicer OE M16WK105-25 Meritor / Rockwell R607172	23 1/2"	2 7/32"
17-483 LH	Euclid E-3856 Spicer OE M16WK104-25 Meritor / Rockwell R607171		

Spicer 16 1/2" Brake

Trunnion Axles, 1 1/16" Tip

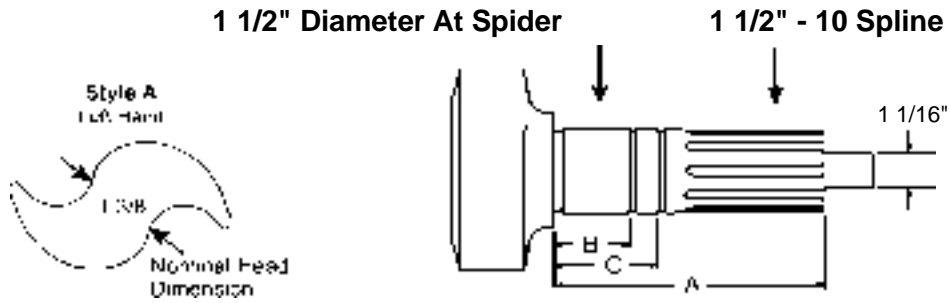

General Information:

- All Cam Lengths ("A" Dim.) Are Measured From Under Cam Head to Cam End.
- Spicer 8 And 16 Wheel Custom Designed Trunnion Suspensions
- Double Grooved

Spicer No.	A Dim.	B Dim.	C Dim.
17-600 RH	4 7/8"	1 5/8"	2 7/32"
17-601 LH			
17-602 RH	5 1/2"	1 5/8"	2 7/32"
17-603 LH			
17-604 RH	6 1/8"	1 5/8"	2 7/32"
17-605 LH			
17-606 RH	6 3/4"	1 5/8"	2 7/32"
17-607 LH			

Spicer 16 1/2" Brake

Trunnion Axles, 1 1/2" Tip

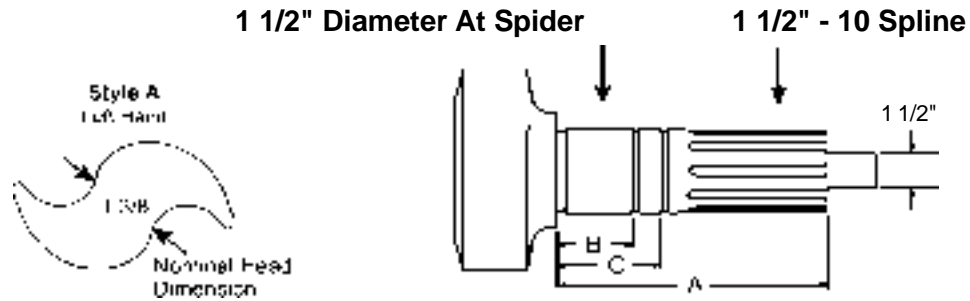

General Information:

- All Cam Lengths ("A" Dim.) Are Measured From Under Cam Head to Cam End.
- 20-50 Ton Trunnion Suspensions
- 16 Wheel 10-16' Wide Units
- Double Grooved

Spicer No.	Replaces	A Dim.	B Dim.	C Dim.
17-608 RH	Spicer OE M16WKR10-073	7 3/8"	1 5/8"	2 7/32"
17-609 LH	Spicer OE M16WKL10-073			
17-610 RH	Euclid E-4893	7 5/8"	1 5/8"	2 7/32"
17-611 LH	Euclid E-4892			
17-612 RH		8 7/8"	1 5/8"	2 7/32"
17-613 LH				

Spicer 16 1/2" Brake

"Xtralife" (XL) Brake

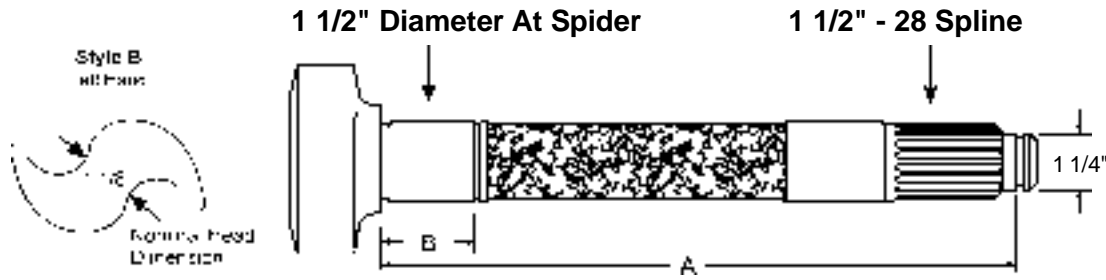

General Information:

- All Cam Lengths ("A" Dim.) Are Measured From Under Cam Head to Beginning of Lock Ring Groove.
- When Replacing High Rise "S" With Standard "S" Head, We Recommend They be Replaced in Pairs.
- Refer to Camshaft Enclosures Section For Detailed Information.
- Use Camshaft Repair Kit:
 - 43-7032 (Weld-On Spider with Nylon Bushings)
 - 43-7032A (Weld-On Spider with Bronze Bushings)
 - 43-7117 (Weld-On Spider with Bronze Bushings and New Style Bracket Assembly)

Spicer No.	Replaces	A Dim.	B Dim.	
17-520 RH	Meritor / Rockwell 2210-V-7718 Spicer OE M16WKR20-166	16 1/2"	2 7/32"	
17-521 LH	Meritor / Rockwell 2210-W-7719 Spicer OE M16WKL20-166			
17-530 RH	Euclid E-9097 Spicer OE M16WKR20-173 Meritor / Rockwell R607196	17 1/8"	2 7/32"	
17-531 LH	Euclid E-9096 Spicer OE M16WKL20-173 Meritor / Rockwell R607195			
17-512 RH	Euclid E-5523 Spicer OE M16WKR20-175 Meritor / Rockwell R607180	17 3/8"	2 7/32"	
17-513 LH	Euclid E-5522 Spicer OE M16WKL20-175 Meritor / Rockwell R607179			
17-500 RH	Euclid E-5525 Spicer OE M16WKR20-205 Meritor / Rockwell R607182	20 3/8"	2 7/32"	
17-501 LH	Euclid E-5524 Spicer OE M16WKL20-205 Meritor / Rockwell R607181			
17-524 RH	Spicer OE M16WKR20-227	22 5/8"	2 7/32"	
17-525 LH	Spicer OE M16WKL20-227			

Continued Next Page

**Spicer 16 1/2" Brake
(Continued)**

"Xtralife" (XL) Brake

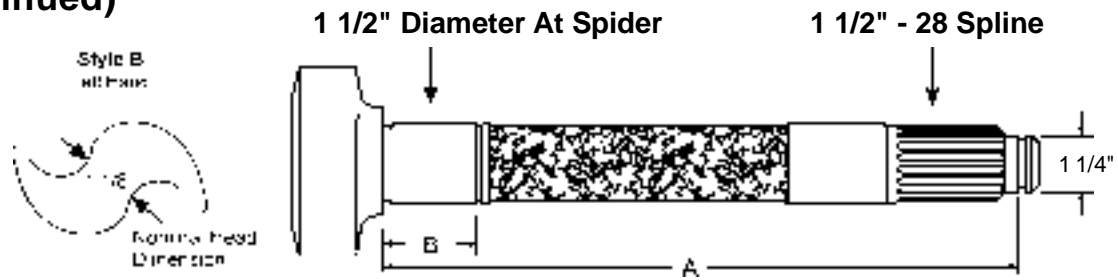

General Information:

- All Cam Lengths ("A" Dim.) Are Measured From Under Cam Head to Beginning of Lock Ring Groove.
- When Replacing High Rise "S" With Standard "S" Head, We Recommend They be Replaced in Pairs.
- Refer to Camshaft Enclosures Section For Detailed Information.
- Use Camshaft Repair Kit:
 - 43-7032 (Weld-On Spider with Nylon Bushings)
 - 43-7032A (Weld-On Spider with Bronze Bushings)
 - 43-7117 (Weld-On Spider with Bronze Bushings and New Style Bracket Assembly)

Spicer No.	Replaces	A Dim.	B Dim.
17-510 RH	Euclid E-9099 Spicer OE M16WKR20-231 Meritor / Rockwell R607198	22 7/8"	2 7/32"
17-511 LH	Euclid E-9098 Spicer OE M16WKL20-231 Meritor / Rockwell R607197		
17-502 RH	Euclid E-5527 Spicer OE M16WKR20-236 Meritor / Rockwell R607184	23 1/2"	2 7/32"
17-503 LH	Euclid E-5526 Spicer OE M16WKL20-236 Meritor / Rockwell R607183		
17-490 RH	Spicer OE M16WKR20-241	23 7/8"	2 7/32"
17-491 LH	Spicer OE M16WKL20-241		
17-514 RH	Euclid E-9101 Spicer OE M16WKR20-242 Meritor / Rockwell R607200	24"	2 7/32"
17-515 LH	Euclid E-9100 Spicer OE M16WKL20-242 Meritor / Rockwell R607199		
17-492 RH	Spicer OE M16WKR20-262	26"	2 7/32"
17-493 LH	Spicer OE M16WKL20-262		
17-526 RH	Spicer OE M16WKR20-264	26 1/4"	2 7/32"
17-527 LH	Spicer OE M16WKL20-264		

Continued Next Page

**Spicer 16 1/2" Brake
(Continued)**

"Xtralife" (XL) Brake

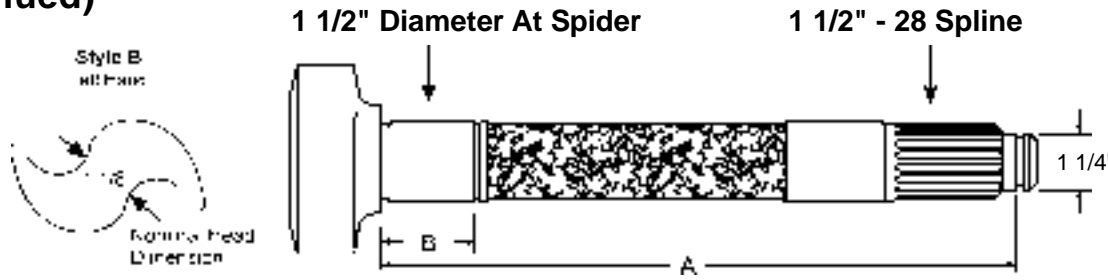

General Information:

- All Cam Lengths ("A" Dim.) Are Measured From Under Cam Head to Beginning of Lock Ring Groove.
- When Replacing High Rise "S" With Standard "S" Head, We Recommend They be Replaced in Pairs.
- Refer to Camshaft Enclosures Section For Detailed Information.
- Use Camshaft Repair Kit:
 - 43-7032 (Weld-On Spider with Nylon Bushings)
 - 43-7032A (Weld-On Spider with Bronze Bushings)
 - 43-7117 (Weld-On Spider with Bronze Bushings and New Style Bracket Assembly)

Spicer No.	Replaces	A Dim.	B Dim.
17-522 RH	Euclid E-9730 Spicer OE M16WKR20-271 Meritor / Rockwell R607226	26 7/8"	2 7/32"
17-523 LH	Euclid E-9729 Spicer OE M16WKL20-271 Meritor / Rockwell R607225		
17-528 RH	Spicer OE M16WKR20-304	30 1/4"	2 7/32"
17-529 LH	Spicer OE M16WKL20-304		

Spicer 16 1/2" Brake

“Xtralife” (XL) Brake

(Used On Axles Manufactured After September, 1995)

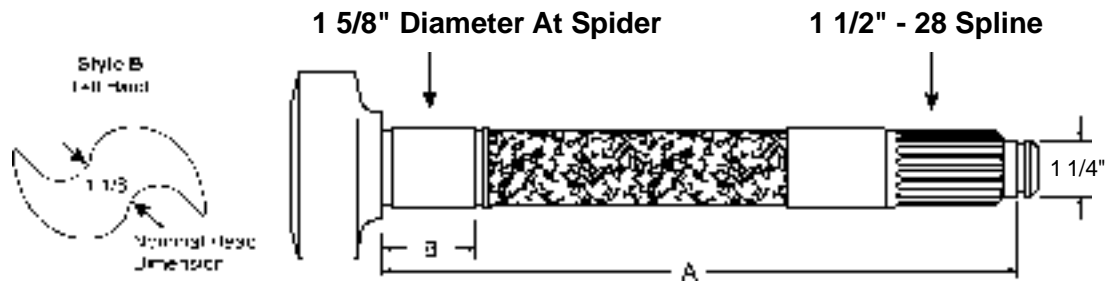

General Information:

- All Cam Lengths (“A” Dim.) Are Measured From Under Cam Head to Beginning of Lock Ring Groove.
- When Replacing High Rise “S” With Standard “S” Head, We Recommend They be Replaced in Pairs.
- Use Camshaft Repair Kit: 43-7118

Spicer No.	Replaces	A Dim.	B Dim.
17-912 RH	Spicer OE M16WKR25-166	16 1/2"	2 7/32"
17-913 LH	Spicer OE M16WKL25-166		
17-914 RH	Euclid E-9732 Spicer OE M16WKR25-175 Meritor / Rockwell R607228	17 3/8"	2 7/32"
17-915 LH	Euclid E-9731 Spicer OE M16WKL25-175 Meritor / Rockwell R607227		
17-920 RH	Euclid E-9734 Spicer OE M16WKR25-205 Meritor / Rockwell R607230	20 3/8"	2 7/32"
17-921 LH	Euclid E-9733 Spicer OE M16WKL25-205 Meritor / Rockwell R607229		
17-922 RH	Spicer OE M16WKR25-215	21 3/8"	2 7/32"
17-923 LH	Spicer OE M16WKL25-215		
17-932 RH	Spicer OE M16WKR25-225	22 3/8"	2 7/32"
17-933 LH	Spicer OE M16WKL25-225		
17-924 RH	Spicer OE M16WKR25-227	22 5/8"	2 7/32"
17-925 LH	Spicer OE M16WKL25-227		
17-926 RH	Spicer OE M16WKR25-231	22 7/8"	2 7/32"
17-927 LH	Spicer OE M16WKL25-231		
17-928 RH	Euclid E-9736 Spicer OE M16WKR25-236 Meritor / Rockwell R607232	23 1/2"	2 7/32"
17-929 LH	Euclid E-9735 Spicer OE M16WKL25-236 Meritor / Rockwell R607231		

Continued Next Page

Spicer 16 1/2" Brake
 (Used On Axles Manufactured After September, 1995)

"Xtralife" (XL) Brake

(Continued)

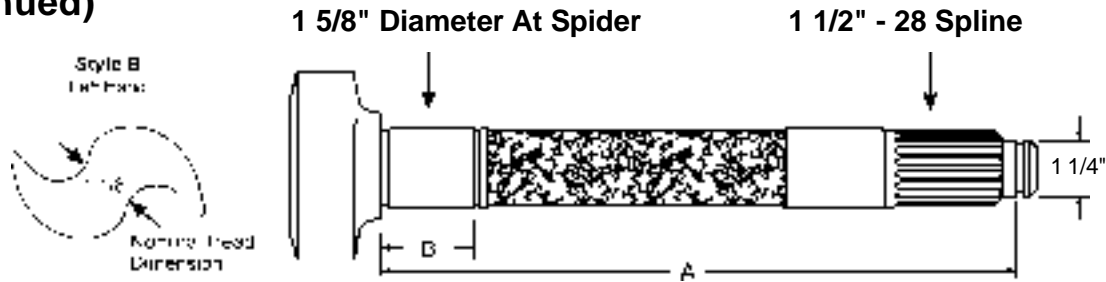

General Information:

- All Cam Lengths ("A" Dim.) Are Measured From Under Cam Head to Beginning of Lock Ring Groove.
- When Replacing High Rise "S" With Standard "S" Head, We Recommend They be Replaced in Pairs.
- Use Camshaft Repair Kit: 43-7118

Spicer No.	Replaces	A Dim.	B Dim.
17-930 RH	Euclid E-10910 Spicer OE M16WKR25-242 Meritor / Rockwell R607278	24"	2 7/32"
17-931 LH	Euclid E-10909 Spicer OE M16WKL25-242 Meritor / Rockwell R607277		
17-936 RH	Spicer OE M16WKR25-264	26 1/4"	2 7/32"
17-937 LH	Spicer OE M16WKL25-264		
17-940 RH	Euclid E-9738 Spicer OE M16WKR25-271 Meritor / Rockwell R607234	26 7/8"	2 7/32"
17-941 LH	Euclid E-9737 Spicer OE M16WKL25-271 Meritor / Rockwell R607233		
17-946 RH	Spicer OE M16WKR25-304	30 1/4"	2 7/32"
17-947 LH	Spicer OE M16WKL25-304		

Spicer 16 1/2" Brake

"Xtralife" (XL) Brake

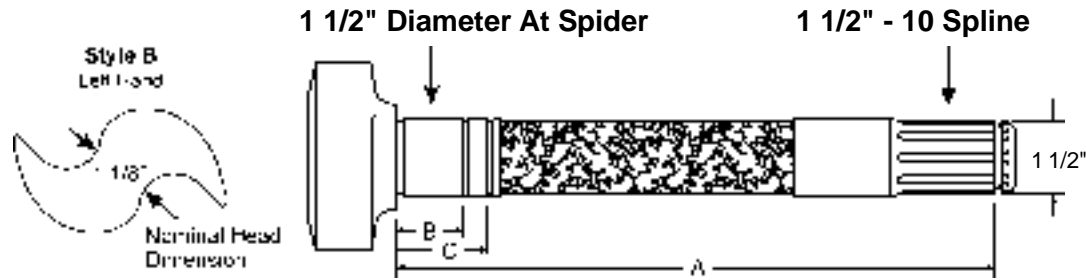

General Information:

- All Cam Lengths ("A" Dim.) Are Measured From Under Cam Head to Beginning of Lock Ring Groove.
- Double Grooved
- When Replacing High Rise "S" With Standard "S" Head, We Recommend They be Replaced In Pairs.
- Refer to Camshaft Enclosures Section For Detailed Information.
- Use Camshaft Repair Kit:
 - 43-7032 (Weld-On Spider with Nylon Bushings)
 - 43-7032A (Weld-On Spider with Bronze Bushings)
 - 43-7117 (Weld-On Spider with Bronze Bushings and New Style Bracket Assembly)

Spicer No.	Replaces	A Dim.	B Dim.	C Dim.
17-540 RH	Spicer OE M16WKR10-164	16 5/16"	1 5/8"	2 7/32"
17-541 LH	Spicer OE M16WKL10-164			
17-542 RH	Spicer OE M16WKR10-166	16 1/2"	1 5/8"	2 7/32"
17-543 LH	Spicer OE M16WKL10-166			
17-516 RH	Euclid E-5517 Spicer OE M16WKR10-175 Meritor / Rockwell R607174	17 3/8"	1 5/8"	2 7/32"
17-517 LH	Euclid E-5516 Spicer OE M16WKL10-175 Meritor / Rockwell R607173			
17-544 RH	Spicer OE M16WKR10-180	17 3/4"	1 5/8"	2 7/32"
17-545 LH	Spicer OE M16WKL10-180			
17-546 RH	Spicer OE M16WKR10-185	18 3/8"	1 5/8"	2 7/32"
17-547 LH	Spicer OE M16WKL10-185			
17-548 RH	Spicer OE M16WKR10-187	18 5/8"	1 5/8"	2 7/32"
17-549 LH	Spicer OE M16WKL10-187			
17-536 RH	Euclid E-9740 Spicer OE M16WKR10-196 Meritor / Rockwell R607236	19 1/2"	1 5/8"	2 7/32"
17-537 LH	Euclid E-9739 Spicer OE M16WKL10-196 Meritor / Rockwell R607235			

Continued Next Page

Spicer 16 1/2" Brake (Continued)

"Xtralife" (XL) Brake

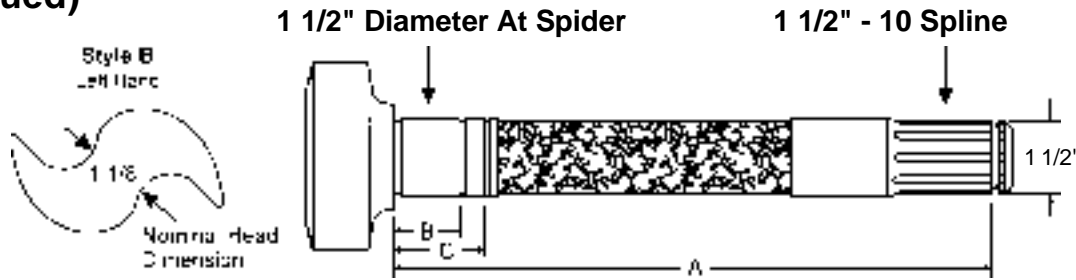

General Information:

- All Cam Lengths ("A" Dim.) Are Measured From Under Cam Head to Beginning of Lock Ring Groove.
- Double Grooved
- When Replacing High Rise "S" With Standard "S" Head, We Recommend They be Replaced In Pairs.
- Refer to Camshaft Enclosures Section For Detailed Information.
- Use Camshaft Repair Kit:
 - 43-7032 (Weld-On Spider with Nylon Bushings)
 - 43-7032A (Weld-On Spider with Bronze Bushings)
 - 43-7117 (Weld-On Spider with Bronze Bushings and New Style Bracket Assembly)

Spicer No.	Replaces	A Dim.	B Dim.	C Dim.
17-504 RH	Euclid E-5519 Spicer OE M16WKR10-205 Meritor / Rockwell R607176	20 3/8"	1 5/8"	2 7/32"
17-505 LH	Euclid E-5518 Spicer OE M16WKL10-205 Meritor / Rockwell R607175			
17-550 RH	Spicer OE M16WKR10-213	21 1/8"	1 5/8"	2 7/32"
17-551 LH	Spicer OE M16WKL10-213			
17-562 RH	Spicer OE M16WKR10-222	22"	1 5/8"	2 7/32"
17-563 LH	Spicer OE M16WKL10-222			
17-552 RH	Spicer OE M16WKR10-227	22 5/8"	1 5/8"	2 7/32"
17-553 LH	Spicer OE M16WKL10-227			
17-518 RH	Euclid E-6102 Spicer OE M16WKR10-231 Meritor / Rockwell R607186	22 7/8"	1 5/8"	2 7/32"
17-519 LH	Euclid E-6101 Spicer OE M16WKL10-231 Meritor / Rockwell R607185			
17-508 RH	Euclid E-5521 Spicer OE M16WKR10-236 Meritor / Rockwell R607178	23 1/2"	1 5/8"	2 7/32"
17-509 LH	Euclid E-5520 Spicer OE M16WKL10-236 Meritor / Rockwell R607177			

Continued Next Page

**Spicer 16 1/2" Brake
(Continued)**

"Xtralife" (XL) Brake

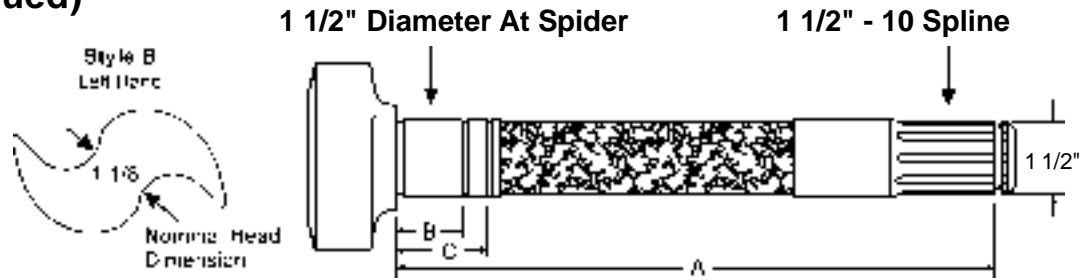

General Information:

- All Cam Lengths ("A" Dim.) Are Measured From Under Cam Head to Beginning of Lock Ring Groove.
- Double Grooved
- When Replacing High Rise "S" With Standard "S" Head, We Recommend They be Replaced In Pairs.
- Refer to Camshaft Enclosures Section For Detailed Information.
- Use Camshaft Repair Kit:
 - 43-7032 (Weld-On Spider with Nylon Bushings)
 - 43-7032A (Weld-On Spider with Bronze Bushings)
 - 43-7117 (Weld-On Spider with Bronze Bushings and New Style Bracket Assembly)

Spicer No.	Replaces	A Dim.	B Dim.	C Dim.
17-506 RH	Euclid E-9728 Spicer OE M16WKR10-242 Meritor / Rockwell R607224	24"	1 5/8"	2 7/32"
17-507 LH	Euclid E-9727 Spicer OE M16WKL10-242 Meritor / Rockwell R607223			
17-554 RH	Euclid E-6104 Spicer OE M16WKR10-245 Meritor / Rockwell R607188	24 3/8"	1 5/8"	2 7/32"
17-555 LH	Euclid E-6103 Spicer OE M16WKL10-245 Meritor / Rockwell R607187			
17-534 RH	Spicer OE M16WKR10-250	24 3/4"	1 5/8"	2 7/32"
17-535 LH	Spicer OE M16WKL10-250			
17-538 RH	Spicer OE M16WKR10-260	25 3/4"	1 5/8"	2 7/32"
17-539 LH	Spicer OE M16WKL10-260			
17-556 RH	Euclid E-9742 Spicer OE M16WKR10-264 Meritor / Rockwell R607238	26 1/4"	1 5/8"	2 7/32"
17-557 LH	Euclid E-9741 Spicer OE M16WKL10-264 Meritor / Rockwell R607237			
17-558 RH	Spicer OE M16WKR10-266	26 1/2"	1 5/8"	2 7/32"
17-559 LH	Spicer OE M16WKL10-266			
17-564 RH	Spicer OE M16WKR10-304	30 1/4"	1 5/8"	2 7/32"
17-565 LH	Spicer OE M16WKL10-304			

Spicer 16 1/2" Brake
 (Used On Axles Manufactured After September, 1995)

"Xtralife" (XL) Brake

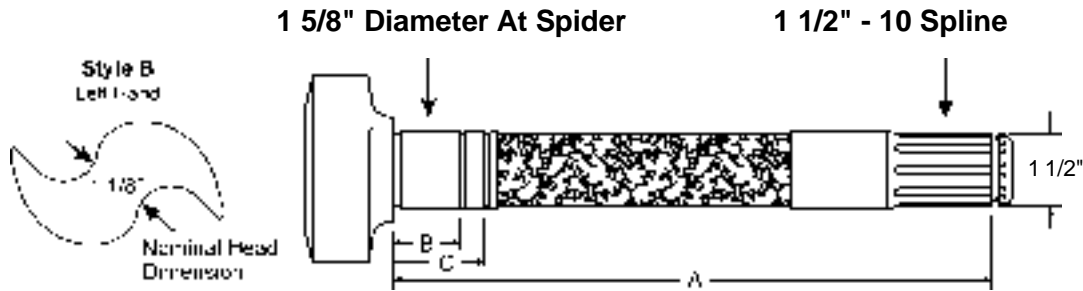

General Information:

- All Cam Lengths ("A" Dim.) Are Measured From Under Cam Head to Beginning of Lock Ring Groove.
- Double Grooved
- When Replacing High Rise "S" With Standard "S" Head, We Recommend They be Replaced in Pairs.
- Use Camshaft Repair Kit: 43-7118

Spicer No.	Replaces	A Dim.	B Dim.	C Dim.
17-840 RH	Spicer OE M16WKR15-164	16 5/16"	1 5/8"	2 7/32"
17-841 LH	Spicer OE M16WKL15-164			
17-842 RH	Spicer OE M16WKR15-166	16 1/2"	1 5/8"	2 7/32"
17-843 LH	Spicer OE M16WKL15-166			
17-844 RH	Spicer OE M16WKR15-175	17 3/8"	1 5/8"	2 7/32"
17-845 LH	Spicer OE M16WKL15-175			
17-846 RH	Spicer OE M16WKR15-180	17 3/4"	1 5/8"	2 7/32"
17-847 LH	Spicer OE M16WKL15-180			
17-848 RH	Spicer OE M16WKR15-185	18 3/8"	1 5/8"	2 7/32"
17-849 LH	Spicer OE M16WKL15-185			
17-850 RH	Spicer OE M16WKR15-187	18 5/8"	1 5/8"	2 7/32"
17-851 LH	Spicer OE M16WKL15-187			
17-852 RH	Spicer OE M16WKR15-205	20 3/8"	1 5/8"	2 7/32"
17-853 LH	Spicer OE M16WKL15-205			
17-854 RH	Spicer OE M16WKR15-213	21 1/8"	1 5/8"	2 7/32"
17-855 LH	Spicer OE M16WKL15-213			
17-856 RH	Spicer OE M16WKR15-222	22"	1 5/8"	2 7/32"
17-857 LH	Spicer OE M16WKL15-222			
17-858 RH	Spicer OE M16WKR15-227	22 5/8"	1 5/8"	2 7/32"
17-859 LH	Spicer OE M16WKL15-227			
17-860 RH	Spicer OE M16WKR15-231	22 7/8"	1 5/8"	2 7/32"
17-861 LH	Spicer OE M16WKL15-231			

Continued Next Page

Spicer 16 1/2" Brake
 (Used On Axles Manufactured After September, 1995)

"Xtralife" (XL) Brake

(Continued)

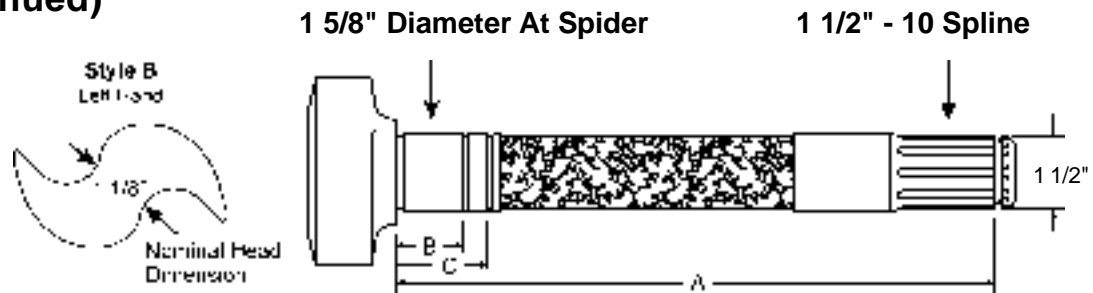

General Information:

- All Cam Lengths ("A" Dim.) Are Measured From Under Cam Head to Beginning of Lock Ring Groove.
- Double Grooved
- When Replacing High Rise "S" With Standard "S" Head, We Recommend They be Replaced in Pairs.
- Use Camshaft Repair Kit: 43-7118

Spicer No.	Replaces	A Dim.	B Dim.	C Dim.
17-862 RH	Spicer OE M16WKR15-236	23 1/2"	1 5/8"	2 7/32"
17-863 LH	Spicer OE M16WKL15-236			
17-864 RH	Spicer OE M16WKR15-242	24"	1 5/8"	2 7/32"
17-865 LH	Spicer OE M16WKL15-242			
17-866 RH	Spicer OE M16WKR15-245	24 3/8"	1 5/8"	2 7/32"
17-867 LH	Spicer OE M16WKL15-245			
17-868 RH	Spicer OE M16WKR15-260	25 3/4"	1 5/8"	2 7/32"
17-869 LH	Spicer OE M16WKL15-260			
17-870 RH	Spicer OE M16WKR15-264	26 1/4"	1 5/8"	2 7/32"
17-871 LH	Spicer OE M16WKL15-264			
17-872 RH	Spicer OE M16WKR15-266	26 1/2"	1 5/8"	2 7/32"
17-873 LH	Spicer OE M16WKL15-266			
17-880 RH	Spicer OE M16WKR15-304	30 1/4"	1 5/8"	2 7/32"
17-881 LH	Spicer OE M16WKL15-304			

Spicer 20" Brake

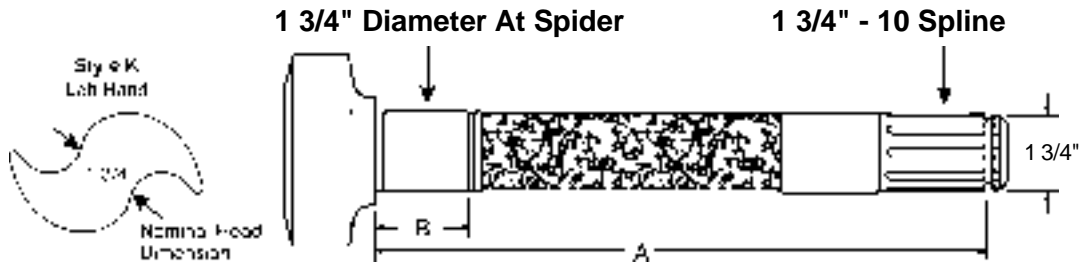

General Information:

- All Cam Lengths ("A" Dim.) Are Measured From Under Cam Head to Beginning of Lock Ring Groove.
- Use Camshaft Repair Kit: 43-7056

Spicer No.	Replaces	A Dim.	B Dim.
17-670 RH	Std. Forge 202101-205R Spicer OE M20WK102-1	20 3/8"	2 7/32"
17-671 LH	Std. Forge 202101-205L Spicer OE M20WK103-1		
17-672 RH	Std. Forge 202101-242R Spicer OE M20WK102-3	24"	2 7/32"
17-673 LH	Std. Forge 202101-242L Spicer OE M20WK103-3		

**Standard Forge and Kershaw
Trailer Axle Brake**

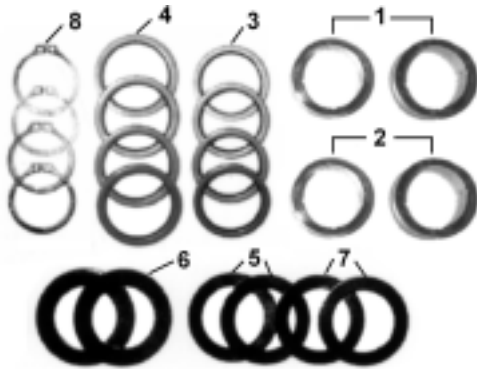

Full Kit Number: 43-7029
Half Kit Number: 43-7029-1

Item No.	Spicer No.	Description	Full Kit Qty.	Half Kit Qty.
1	28-1232	Camshaft Spider Bushing	2	1
2	28-1233	Camshaft Spider Bushing	2	1
3	29-1266	Camshaft Seal	4	2
4	29-1270	Camshaft Seal	4	2
5	29-1310	Camshaft Washer	2	1
6	29-1311	Camshaft Washer	2	1
7	29-1307	Camshaft Washer	2	1
8	29-1301	Camshaft Lockring	4	2

General Information

- 16 1/2" Brake
- 1 1/2" Diameter at Spider
- Rigid Cam Bracket with Nylon Bushings

**Spicer and Standard Forge
Trailer Axle Brakes**

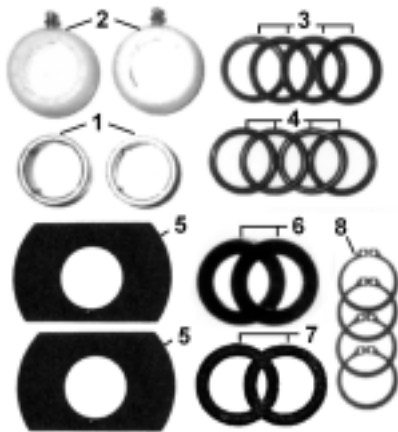

Full Kit Number: 43-7030
Half Kit Number: 43-7030-1

Item No.	Spicer No.	Description	Full Kit Qty.	Half Kit Qty.
1	28-1231	Camshaft Spider Bushing	2	1
2	27-1191	Cam Bracket Bushing	2	1
3	27-1208	Camshaft Bushing O-Ring	4	2
4	29-1269	Spider Seal	4	2
5	29-1310	Camshaft Washer	2	1
6	29-1311	Camshaft Washer	2	1
7	29-1307	Camshaft Washer	2	1
8	29-1301	Camshaft Lockring	4	2

General Information

- 16 1/2" and 18" Brakes
- 1 1/2" Diameter at Spider
- Bronze Spider Bushings

NOTE: Full Kit will service one axle
 Half Kit will service one S-camshaft

Spicer Trailer Axle Brake

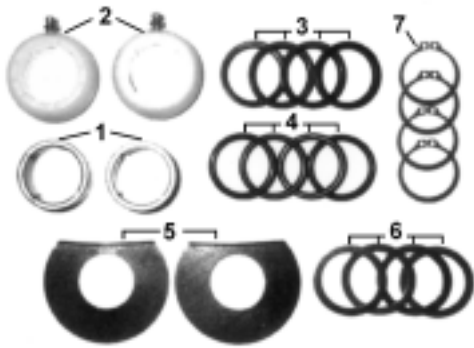

Full Kit Number: 43-7031
Half Kit Number: 43-7031-1

Item No.	Spicer No.	Description	Full Kit Qty.	Half Kit Qty.
1	28-1231	Camshaft Spider Bushing	2	1
2	27-1191	Cam Bracket Bushing	2	1
3	27-1208	Camshaft Bushing O-Ring	4	2
4	29-1269	Spider Seal	4	2
5	29-1318	Camshaft Washer	2	1
6	29-1309	Camshaft Washer	4	2
7	29-1301	Camshaft Lockring	4	2

General Information

- 12 1/4" Brake
- 1 1/2" Diameter at Spider
- Weld-on Spider With Bronze Bushing

Spicer Trailer Axle Brake

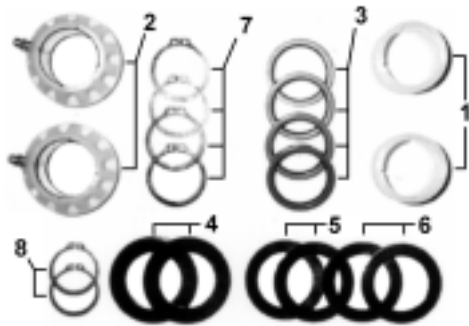

Full Kit Number: 43-7032
Half Kit Number: 43-7032-1

Item No.	Spicer No.	Description	Full Kit Qty.	Half Kit Qty.
1	28-1232	Camshaft Spider Bushing	2	1
2	27-1195	Cam Bracket Bushing	2	1
3	29-1266	Camshaft Seal	4	2
4	29-1311	Camshaft Washer	2	1
5	29-1307	Camshaft Washer	2	1
6	29-1308	Camshaft Washer	2	1
7	29-1301	Camshaft Lockring	4	2
8	34-1525	Camshaft Lockring	2	1

General Information

- 16 1/2" Standard and "XL" Brakes
- 1 1/2" Diameter at Spider
- Weld-on Spider With Nylon Bushing

NOTE: Full Kit will service one axle
 Half Kit will service one S-camshaft

Spicer Trailer Axle Brake

Full Kit Number: 43-7032A
Half Kit Number: 43-7032A-1

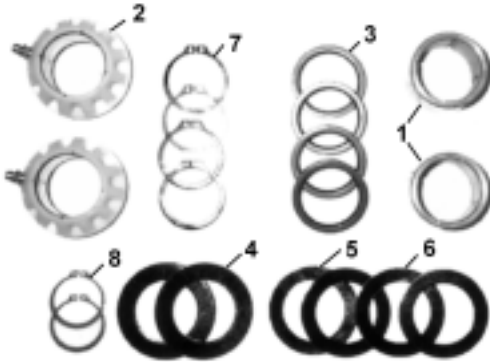

Item No.	Spicer No.	Description	Full Kit Qty.	Half Kit Qty.
1	28-1231	Camshaft Spider Bushing	2	1
2	27-1195	Cam Bracket Bushing	2	1
3	29-1266	Camshaft Seal	4	2
4	29-1311	Camshaft Washer	2	1
5	29-1307	Camshaft Washer	2	1
6	29-1308	Camshaft Washer	2	1
7	29-1301	Camshaft Lockring	4	2
8	34-1525	Camshaft Lockring	2	1

General Information

- 16 1/2" Standard and "XL" Brakes
- 1 1/2" Diameter at Spider
- Weld-on Spider With Bronze Bushing

Spicer and Dexter Trailer Axle Brakes

Full Kit Number: 43-7033
Half Kit Number: 43-7033-1

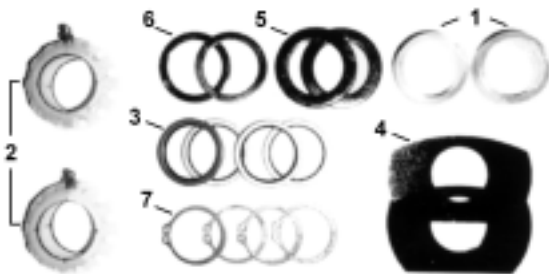

Item No.	Spicer No.	Description	Full Kit Qty.	Half Kit Qty.
1	28-1232	Camshaft Spider Bushing	2	1
2	27-1195	Cam Bracket Bushing	2	1
3	29-1269	Spider Seal	4	2
4	29-1319	Camshaft Washer	2	1
5	29-1326	Camshaft Washer	2	1
6	29-1309	Camshaft Washer	2	1
7	29-1301	Camshaft Lockring	4	2

General Information

- 12 1/4" Brake
- 1 1/2" Diameter at Spider
- New Style 4-Bolt S-Camshaft Bracket, After 1990

NOTE: Full Kit will service one axle
 Half Kit will service one S-camshaft

Rockwell Drive Axle Brake

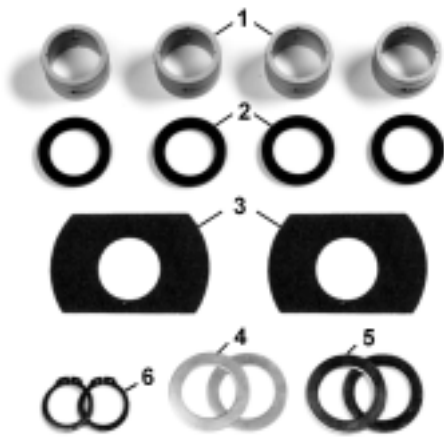

Full Kit Number: 43-7034
Half Kit Number: 43-7034-1

Item No.	Spicer No.	Description	Full Kit Qty.	Half Kit Qty.
1	28-1233	Camshaft Spider Bushing	4	2
2	29-1270	Camshaft Seal	4	2
3	29-1310	Camshaft Washer	2	1
4	29-1307	Camshaft Washer	2	1
5	29-1308	Camshaft Washer	2	1
6	29-1301	Camshaft Lockring	2	1

General Information

- 16 1/2" and 18" Brakes
- 1 1/2" Diameter at Spider
- Nylon Spider Bushings
- Short Kit for 43-7047

Rockwell Trailer Axle Brake

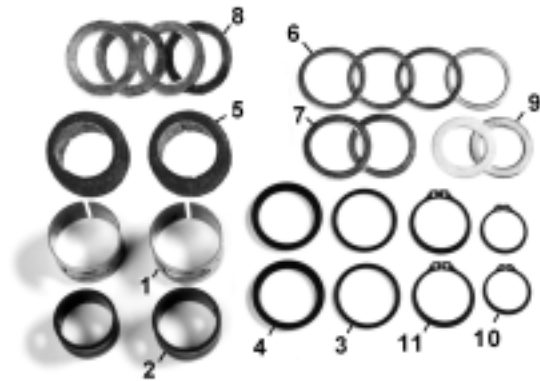

Full Kit Number: 43-7037
Half Kit Number: 43-7037-1

Item No.	Spicer No.	Description	Full Kit Qty.	Half Kit Qty.
1	28-1240	Camshaft Steel Outer Bushing	2	1
2	28-1241	Camshaft Plastic Inner Bushing	2	1
3	29-1275	Camshaft Seal	2	1
4	29-1274	Spider Seal	2	1
5	27-1197	Cam Bracket Bushing	2	1
6	27-1208	Camshaft Bushing O-Ring	4	2
7	29-1309	Camshaft Washer	2	1
8	29-1322	Camshaft Washer	4	2
9	35-1580	Anchor Pin Washer	2	1
10	34-1525	Camshaft Lockring	2	1
11	29-1302	Camshaft Lockring	2	1

General Information

- 12 1/4" and 16 1/2" Brakes
- 1 5/8" Diameter at Spider
- Cast Spider
- Contains Bushings Only (Housing Available in 43-7037A)

NOTE: Full Kit will service one axle
 Half Kit will service one S-camshaft

Rockwell Trailer Axle Brake

Full Kit Number: 43-7037A
Half Kit Number: 43-7037A-1

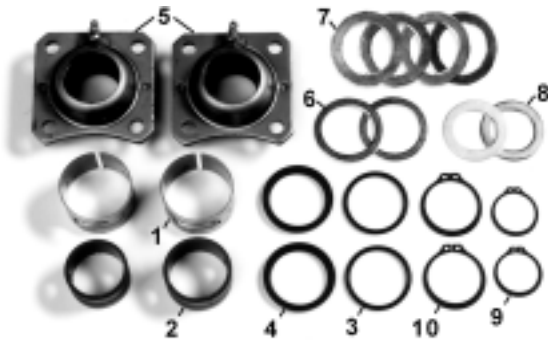

Item No.	Spicer No.	Description	Full Kit Qty.	Half Kit Qty.
1	28-1240	Camshaft Steel Outer Bushing	2	1
2	28-1241	Camshaft Plastic Inner Bushing	2	1
3	29-1275	Camshaft Seal	2	1
4	29-1274	Spider Seal	2	1
5	30-1358	Cam Support Housing	2	1
6	29-1309	Camshaft Washer	2	1
7	29-1322	Camshaft Washer	4	2
8	35-1580	Anchor Pin Washer	2	1
9	34-1525	Camshaft Lockring	2	1
10	29-1302	Camshaft Lockring	2	1

- General Information**
- 12 1/4" and 16 1/2" Brakes
 - 1 5/8" Diameter at Spider
 - Cast Spider
 - 2-Piece Spider Bushing

Rockwell Trailer Axle Brake

Full Kit Number: 43-7037B
Half Kit Number: 43-7037B-1

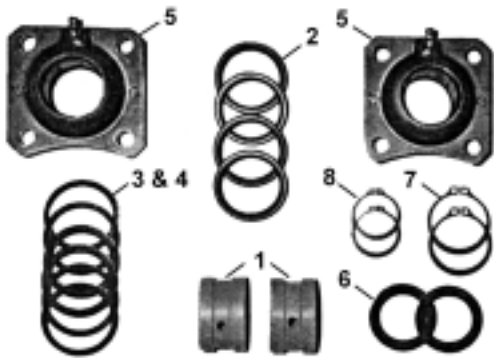

Item No.	Spicer No.	Description	Full Kit Qty.	Half Kit Qty.
1	28-1238	Camshaft Spider Bushing	2	1
2	29-1271	Spider Seal	4	2
3	29-1312	Camshaft Washer	4	2
4	29-1309	Camshaft Washer	2	1
5	30-1358	Cam Support Housing	2	1
6	35-1580	Anchor Pin Washer	2	1
7	29-1302	Camshaft Lockring	2	1
8	34-1525	Camshaft Lockring	2	1

- General Information**
- 12 1/4" and 16 1/2" Brakes
 - 1 5/8" Diameter at Spider
 - Cast Spider
 - 1-Piece Spider Bushing

NOTE: Full Kit will service one axle
 Half Kit will service one S-camshaft

Fruehauf "Pro-Par" Trailer Axle

Full Kit Number: 43-7038
Half Kit Number: 43-7038-1



Item No.	Spicer No.	Description	Full Kit Qty.	Half Kit Qty.
1	28-1237	Camshaft Spider Bushing	4	2
2	27-1198	Cam Bracket Bushing	2	1
3	29-1322	Camshaft Washer	6	3
4	29-1307	Camshaft Washer	2	1
5	29-1302	Camshaft Lockring	2	1
6	29-1301	Camshaft Lockring	2	1

General Information

- 12 1/4" and 16 1/2" Brakes
- 1 5/8" Diameter at Spider
- Early Model S-Camshaft Bracket Bushing

Fruehauf "Pro-Par" Trailer Axle

Full Kit Number: 43-7039
Half Kit Number: 43-7039-1

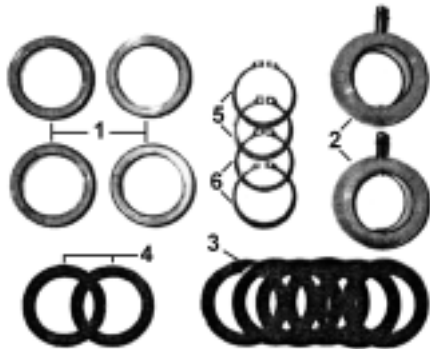

Item No.	Spicer No.	Description	Full Kit Qty.	Half Kit Qty.
1	28-1237	Camshaft Spider Bushing	4	2
2	27-1194	Cam Bracket Bushing	2	1
3	29-1322	Camshaft Washer	6	3
4	29-1307	Camshaft Washer	2	1
5	29-1302	Camshaft Lockring	2	1
6	29-1301	Camshaft Lockring	2	1

General Information

- 12 1/4" and 16 1/2" Brakes
- 1 5/8" Diameter at Spider
- Late Model (Spherical) S-Camshaft Bracket Bushings

NOTE: Full Kit will service one axle
Half Kit will service one S-camshaft

Fruehauf "Pro-Par" Trailer Axle

Full Kit Number: 43-7039A
Half Kit Number: 43-7039A-1

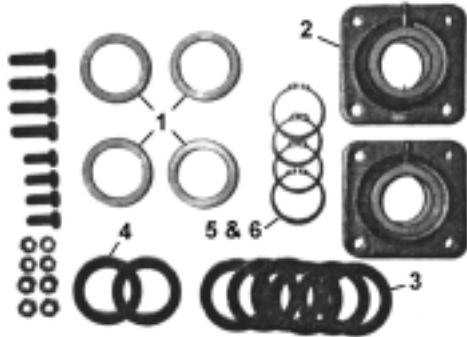

Item No.	Spicer No.	Description	Full Kit Qty.	Half Kit Qty.
1	28-1237	Camshaft Spider Bushing	4	2
2	30-1390	Center Plate Housing	2	1
3	29-1322	Camshaft Washer	6	3
4	29-1307	Camshaft Washer	2	1
5	29-1302	Camshaft Lockring	2	1
6	29-1301	Camshaft Lockring	2	1

General Information

- 12 1/4" and 16 1/2" Brakes
- 1 5/8" Diameter at Spider
- New Design Outboard S-Camshaft Bracket Assembly

Eaton Shuler Trailer Axle Brake

Full Kit Number: 43-7040
Half Kit Number: 43-7040-1

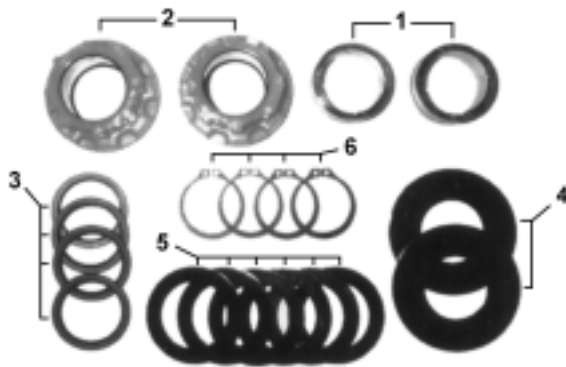

Item No.	Spicer No.	Description	Full Kit Qty.	Half Kit Qty.
1	28-1233	Camshaft Spider Bushing	2	1
2	27-1200	Cam Bracket Bushing	2	1
3	29-1269	Spider Seal	4	2
4	29-1325	Camshaft Washer	2	1
5	29-1307	Camshaft Washer	6	3
6	29-1301	Camshaft Lockring	4	2

General Information

- 12 1/4" Brake
- 1 1/2" Diameter at Spider
- Single Anchor Pin (SAP) Brake

NOTE: Full Kit will service one axle
 Half Kit will service one S-camshaft

Eaton Shuler Drive Axle Brake

Full Kit Number: 43-7041
Half Kit Number: 43-7041-1

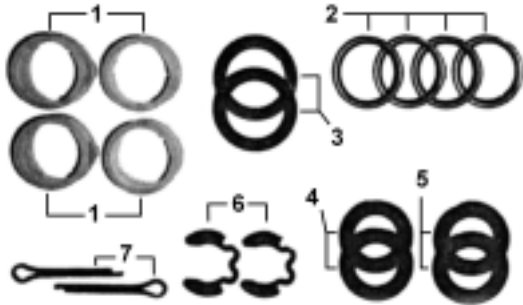

Item No.	Spicer No.	Description	Full Kit Qty.	Half Kit Qty.
1	28-1233	Camshaft Spider Bushing	4	2
2	29-1266	Camshaft Seal	4	2
3	29-1321	Camshaft Washer	2	1
4	29-1320	Camshaft Washer	2	1
5	29-1307	Camshaft Washer	2	1
6	29-1303	Retainer Snap Ring	2	1
7	29-1268	Camshaft Cotter Pin	2	1

General Information

- 16 1/2" Brake
- 1 1/2" Diameter at Spider
- Single Anchor Pin (SAP) Brake

Eaton Shuler Trailer Axle Brake

Full Kit Number: 43-7042
Half Kit Number: 43-7042-1

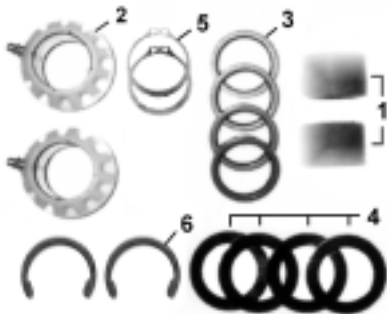

Item No.	Spicer No.	Description	Full Kit Qty.	Half Kit Qty.
1	28-1233	Camshaft Spider Bushing	2	1
2	27-1199	Cam Bracket Bushing	2	1
3	29-1266	Camshaft Seal	4	2
4	29-1307	Camshaft Washer	4	2
5	29-1301	Camshaft Lockring	2	1
6	29-1315	Camshaft Lockring	2	1

General Information

- 16 1/2" Brake
- 1 1/2" Diameter at Spider
- Eaton / Shuler Early Model
- Bolt-on Spider with Nylon Bushings
- Model 22L and 23L
- 5" Round Tube

NOTE: Full Kit will service one axle
 Half Kit will service one S-camshaft

Eaton Trailer Axle Brake

Full Kit Number: 43-7043A
Half Kit Number: 43-7043A-1



Item No.	Spicer No.	Description	Full Kit Qty.	Half Kit Qty.
1	28-1238	Camshaft Spider Bushing	2	1
2	27-1196	Cam Bracket Bushing	2	1
3	29-1274	Spider Seal	4	2
4	29-1322	Camshaft Washer	4	2
5	29-1307	Camshaft Washer	4	2
6	29-1305	Camshaft Lockring	2	1
7	29-1301	Camshaft Lockring	2	1

General Information

- 16 1/2" Standard or ES™ (SAP) Brakes for 501 Series Axle
- 1 5/8" Diameter at Spider

Rockwell Trailer Axle Brake

Full Kit Number: 43-7044
Half Kit Number: 43-7044-1

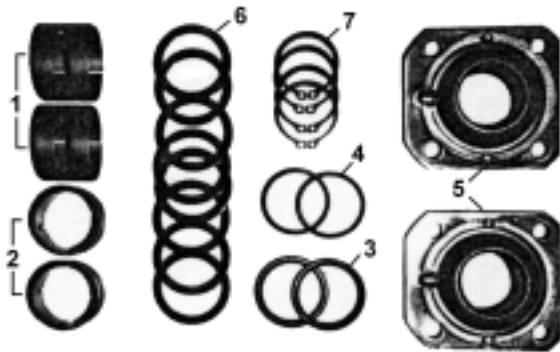

Item No.	Spicer No.	Description	Full Kit Qty.	Half Kit Qty.
1	28-1252	Camshaft Steel Outer Bushing	2	1
2	28-1253	Camshaft Plastic Inner Bushing	2	1
3	29-1269	Spider Seal	2	1
4	29-1267	Camshaft Seal	2	1
5	30-1358	Cam Support Housing	2	1
6	29-1309	Camshaft Washer	8	4
7	29-1301	Camshaft Lockring	4	2

General Information

- 16 1/2" Brake for RN Series Axle
- 1 1/2" Diameter at Spider
- Contains Complete S-Camshaft Bracket Assembly

NOTE: Full Kit will service one axle
 Half Kit will service one S-camshaft

Rockwell Trailer Axle Brake

Full Kit Number: 43-7044A
Half Kit Number: 43-7044A-1

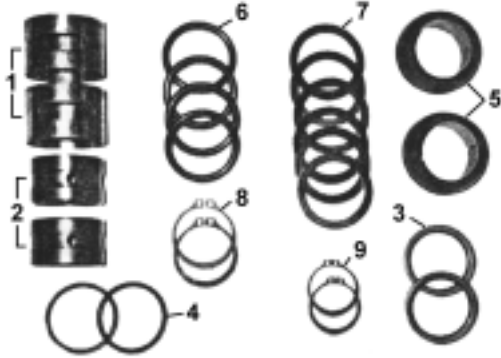

Item No.	Spicer No.	Description	Full Kit Qty.	Half Kit Qty.
1	28-1252	Camshaft Steel Outer Bushing	2	1
2	28-1253	Camshaft Plastic Inner Bushing	2	1
3	29-1269	Spider Seal	2	1
4	29-1267	Camshaft Seal	2	1
5	27-1197	Cam Bracket Bushing	2	1
6	27-1208	Camshaft Bushing O-Ring	4	2
7	29-1309	Camshaft Washer	6	3
8	29-1301	Camshaft Lockring	2	1
9	34-1525	Camshaft Lockring	2	1

General Information

- 16 1/2" Brake for RN Series Axle
- 1 1/2" Diameter at Spider
- Contains Bushings Only (Housing available in 43-7044)

Rockwell Trailer Axle Brake

Full Kit Number: 43-7046
Half Kit Number: 43-7046-1



Item No.	Spicer No.	Description	Full Kit Qty.	Half Kit Qty.
1	28-1235	Camshaft Spider Bushing	2	1
2	28-1236	Camshaft Spider Bushing	2	1
3	30-1358	Cam Support Housing	2	1
4	29-1307	Camshaft Washer	8	4
5	29-1301	Camshaft Lockring	4	2

General Information

- 16 1/2" Brake for "TKL" Series Axle
- 1 1/2" Diameter at Spider
- Early Style with 2-Piece Spider Bushing
- Complete Hanger Bracket Included

NOTE: Full Kit will service one axle
 Half Kit will service one S-camshaft

Rockwell Trailer Axle Brake

Full Kit Number: 43-7046A
Half Kit Number: 43-7046A-1

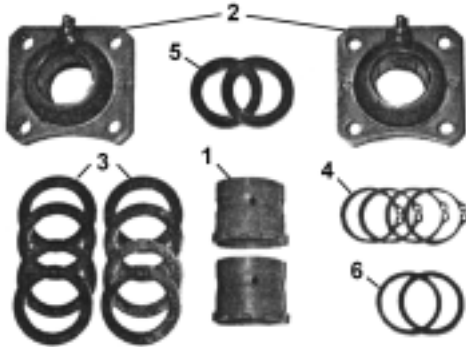

Item No.	Spicer No.	Description	Full Kit Qty.	Half Kit Qty.
1	28-1260	Camshaft Spider Bushing	2	1
2	30-1358	Cam Support Housing	2	1
3	29-1307	Camshaft Washer	8	4
4	29-1301	Camshaft Lockring	4	2
5	29-1267	Camshaft Seal	2	1
6	29-1270	Camshaft Seal	2	1

General Information

- 16 1/2" Brake for "TKL" Axle
- 1 1/2" Diameter at Spider
- Late Style with 1-Piece Spider Bushing
- Complete Hanger Bracket Included

Rockwell Drive Axle Brake

Full Kit Number: 43-7047
Half Kit Number: 43-7047-1

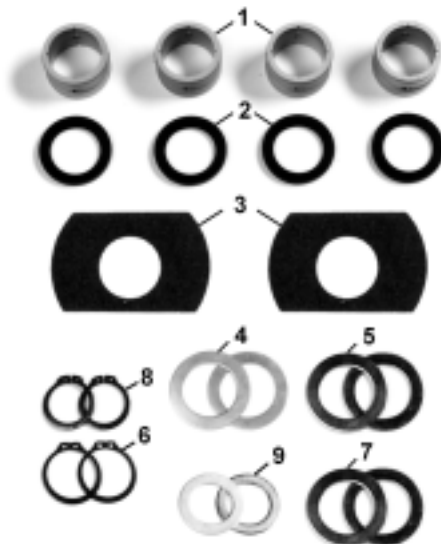

Item No.	Spicer No.	Description	Full Kit Qty.	Half Kit Qty.
1	28-1233	Camshaft Spider Bushing	4	2
2	29-1270	Camshaft Seal	4	2
3	29-1310	Camshaft Washer	2	1
4	29-1307	Camshaft Washer	2	1
5	29-1308	Camshaft Washer	2	1
6	34-1547	Camshaft Lockring	2	1
7	29-1340	Camshaft Washer	2	1
8	29-1301	Camshaft Lockring	2	1
9	35-1580	Anchor Pin Washer	2	1

General Information

- 16 1/2" "P" Series Brake
- 1 1/2" Diameter at Spider

NOTE: Full Kit will service one axle
 Half Kit will service one S-camshaft

Rockwell Drive Axle Brake

Full Kit Number: 43-7048
Half Kit Number: 43-7048-1

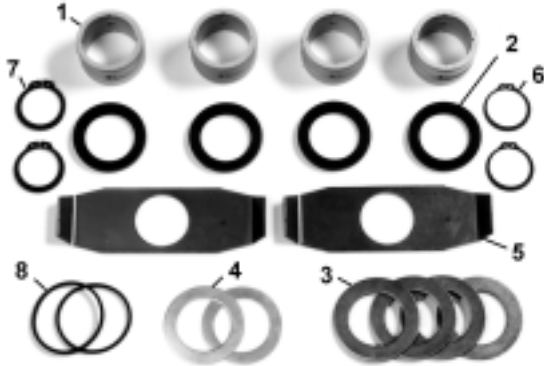

Item No.	Spicer No.	Description	Full Kit Qty.	Half Kit Qty.
1	28-1233	Camshaft Spider Bushing	4	2
2	29-1270	Camshaft Seal	4	2
3	35-1580	Anchor Pin Washer	4	2
4	29-1345	Camshaft Washer	2	1
5	29-1339	Camshaft Washer	2	1
6	34-1525	Camshaft Lockring	2	1
7	34-1547	Camshaft Lockring	2	1
8	27-1208	Camshaft Bushing O-Ring	2	1

General Information

- 16 1/2" "Q" and "Q Plus" Series Brakes
- 1 1/2" Diameter at Spider

Rockwell Drive Axle Brake

Full Kit Number: 43-7048A
Half Kit Number: 43-7048A-1



Item No.	Spicer No.	Description	Full Kit Qty.	Half Kit Qty.
1	28-1233	Camshaft Spider Bushing	4	2
2	29-1270	Camshaft Seal	4	2

General Information

- 16 1/2" Brake
- 1 1/2" Diameter at Spider
- Bushing and Seal Kit for 43-7034, 43-7047 and 43-7048

NOTE: Full Kit will service one axle
 Half Kit will service one S-camshaft

Rockwell Steer Axle Brake

Full Kit Number: 43-7050
Half Kit Number: 43-7050-1

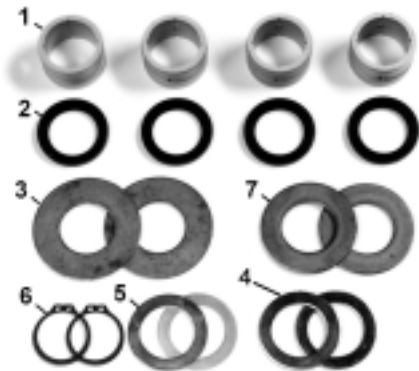

Item No.	Spicer No.	Description	Full Kit Qty.	Half Kit Qty.
1	28-1233	Camshaft Spider Bushing	4	2
2	29-1270	Camshaft Seal	4	2
3	29-1337	Camshaft Washer	2	1
4	29-1308	Camshaft Washer	2	1
5	29-1307	Camshaft Washer	2	1
6	29-1301	Camshaft Lockring	2	1
7	29-1333	Camshaft Washer	2	1

- General Information**
- 15" "T" Series Brake
 - 1 1/2" Diameter at Spider

Rockwell Steer Axle Brake

Full Kit Number: 43-7051
Half Kit Number: 43-7051-1

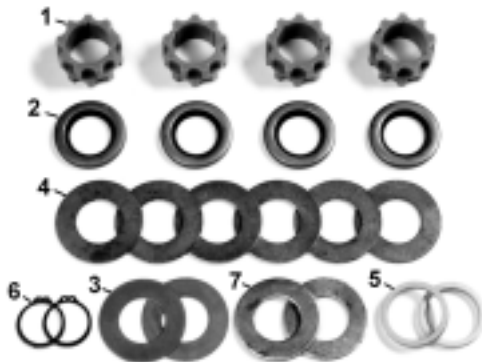

Item No.	Spicer No.	Description	Full Kit Qty.	Half Kit Qty.
1	28-1263	Camshaft Spider Bushing	4	2
2	29-1283	Camshaft Seal	4	2
3	29-1334	Camshaft Washer	2	1
4	29-1338	Camshaft Washer	6	3
5	29-1336	Camshaft Washer	2	1
6	34-1525	Camshaft Lockring	2	1
7	29-1330	Camshaft Washer	2	1

- General Information**
- 15" "T" Series Brake
 - 1 1/4" Diameter at Spider

NOTE: Full Kit will service one axle
 Half Kit will service one S-camshaft

Wagner Front and Rear Axle Brakes

Full Kit Number: 43-7053A
Half Kit Number: 43-7053A-1

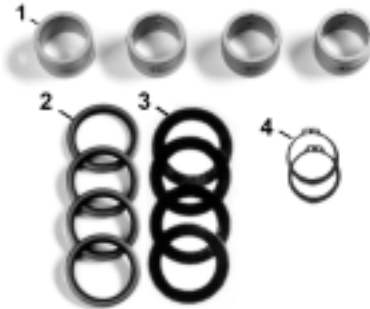

Item No.	Spicer No.	Description	Full Kit Qty.	Half Kit Qty.
1	28-1262	Camshaft Bushing	4	2
2	29-1282	Camshaft Seal	4	2
3	29-1331	Camshaft Washer	4	2
4	34-1525	Camshaft Lockring	2	1

General Information

- 15" x 3", 3 1/2" and 4" Brakes
- 1 1/4" Diameter at Spider

Spicer Trailer Axle Brake

Full Kit Number: 43-7056
Half Kit Number: 43-7056-1

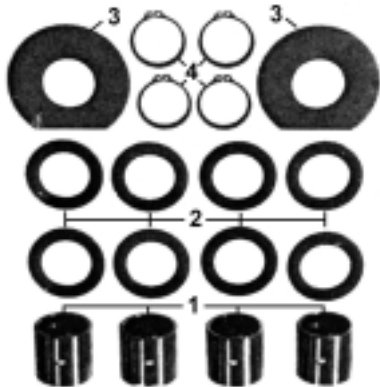

Item No.	Spicer No.	Description	Full Kit Qty.	Half Kit Qty.
1	28-1247	Camshaft Spider Bushing	4	2
2	29-1329	Camshaft Washer	8	4
3	29-1328	Camshaft Washer	2	1
4	29-1304	Camshaft Lockring	4	2

General Information

- 18" x 7" and 20" x 8" Brakes
- 1 3/4" Diameter at Spider
- Spicer A45 Axles

NOTE: Full Kit will service one axle
 Half Kit will service one S-camshaft

Rockwell Steer Axle Brake

Full Kit Number: 43-7059
Half Kit Number: 43-7059-1

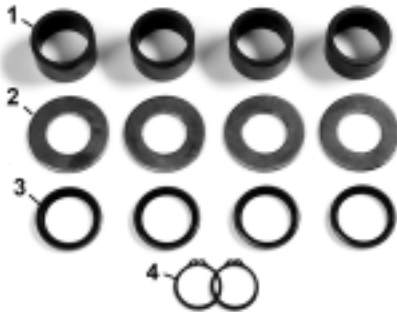

Item No.	Spicer No.	Description	Full Kit Qty.	Half Kit Qty.
1	28-1265	Camshaft Bushing	4	2
2	29-1286	Camshaft Seal	4	2
3	29-1330	Camshaft Washer	4	2
4	34-1560	Camshaft Lockring	2	1

- General Information**
- 15" x 4" "Q" Series Brake
 - 1 1/4" Diameter at Spider

Eaton Steer Axle Brake

Full Kit Number: 43-7060
Half Kit Number: 43-7060-1

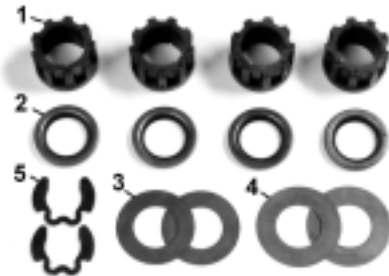

Item No.	Spicer No.	Description	Full Kit Qty.	Half Kit Qty.
1	28-1264	Camshaft Bushing	4	2
2	29-1285	Camshaft Seal	4	2
3	29-1344	Camshaft Washer	2	1
4	29-1346	Camshaft Washer	2	1
5	29-1303	Retainer Snap Ring	2	1

- General Information**
- 15" Single Anchor Pin (SAP) Brake
 - 15" X 4" EST™ Brake
 - 1 1/4" Diameter at Spider

NOTE: Full Kit will service one axle
 Half Kit will service one S-camshaft

Spicer Trailer Axle Brake

Full Kit Number: 43-7062
Half Kit Number: 43-7062-1

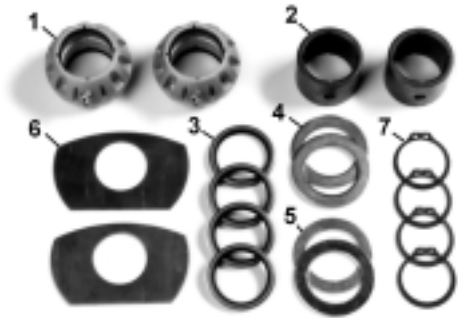

Item No.	Spicer No.	Description	Full Kit Qty.	Half Kit Qty.
1	27-1195	Cam Bracket Bushing	2	1
2	28-1231	Camshaft Spider Bushing	2	1
3	29-1266	Camshaft Seal	4	2
4	29-1326	Camshaft Washer	2	1
5	29-1307	Camshaft Washer	2	1
6	29-1319	Camshaft Washer	2	1
7	29-1301	Camshaft Lockring	4	2

General Information

- 12 1/4" "U" Brake
- 1 1/4" Diameter at Spider

Bendix Steer Axle Brake

Full Kit Number: 43-7064
Half Kit Number: 43-7064-1

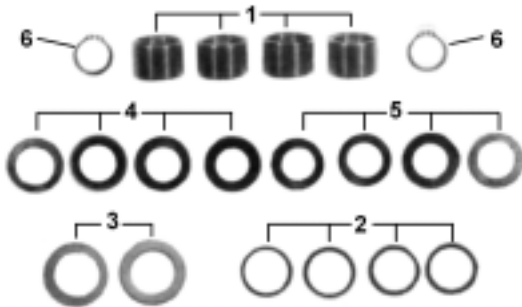

Item No.	Spicer No.	Description	Full Kit Qty.	Half Kit Qty.
1	28-1234	Camshaft Spider Bushing	4	2
2	29-1266	Camshaft Seal	4	2
3	29-1345	Camshaft Washer	2	1
4	29-1321	Camshaft Washer	4	2
5	29-1320	Camshaft Washer	4	2
6	34-1527	Camshaft Lockring	2	1

General Information

- 15" X 4" "Brazilian" Brake (Ford Cargo)
- 1 1/2" Diameter at Spider

NOTE: Full Kit will service one axle
 Half Kit will service one S-camshaft

Bendix Drive Axle Brake

Full Kit Number: 43-7065
Half Kit Number: 43-7065-1

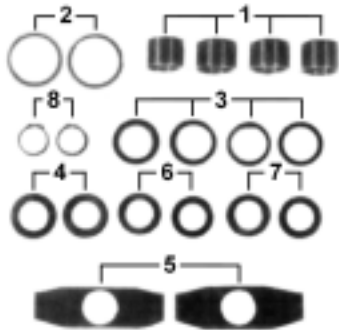

Item No.	Spicer No.	Description	Full Kit Qty.	Half Kit Qty.
1	28-1268	Camshaft Bushing	4	2
2	29-1277	Camshaft Bracket Gasket	2	1
3	29-1270	Camshaft Seal	4	2
4	29-1345	Camshaft Washer	2	1
5	29-1339	Camshaft Washer	2	1
6	29-1320	Camshaft Washer	2	1
7	29-1321	Camshaft Washer	2	1
8	34-1527	Camshaft Lockring	2	1

General Information

- 16 1/2" "Brazilian" Brake (Ford Cargo)
- 1 1/2" Diameter at Spider

Eaton Drive Axle Brake

Full Kit Number: 43-7068
Half Kit Number: 43-7068-1

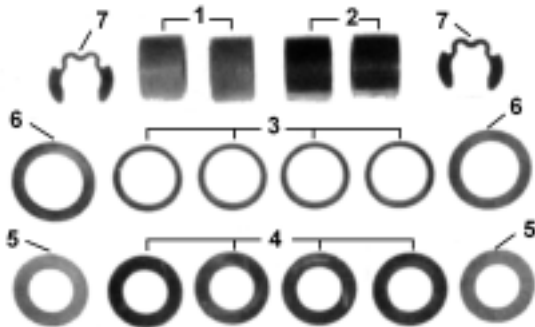

Item No.	Spicer No.	Description	Full Kit Qty.	Half Kit Qty.
1	28-1233	Camshaft Spider Bushing	2	1
2	28-1268	Camshaft Bushing	2	1
3	29-1269	Spider Seal	4	2
4	29-1307	Camshaft Washer	4	2
5	29-1321	Camshaft Washer	2	1
6	29-1320	Camshaft Washer	2	1
7	29-1303	Retainer Snap Ring	2	1

General Information

- 16 1/2" EST™ Brake
- 1 1/2" Diameter at Spider
- Severe Service Bronze Spider Bushings

NOTE: Full Kit will service one axle
 Half Kit will service one S-camshaft

Eaton Drive Axle Brake

Full Kit Number: 43-7069
Half Kit Number: 43-7069-1

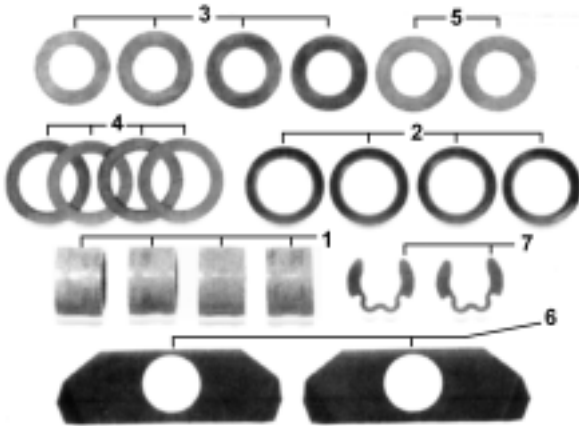

Item No.	Spicer No.	Description	Full Kit Qty.	Half Kit Qty.
1	28-1233	Camshaft Spider Bushing	4	2
2	29-1269	Spider Seal	4	2
3	29-1307	Camshaft Washer	4	2
4	29-1320	Camshaft Washer	4	2
5	29-1321	Camshaft Washer	2	1
6	29-1355	Camshaft Washer	2	1
7	29-1303	Retainer Snap Ring	2	1

- General Information**
- 16 1/2" ES™ Brake
 - 1 1/2" Diameter at Spider
 - Nylon Spider Bushings

Rockwell Steer Axle Brake

Full Kit Number: 43-7070
Half Kit Number: 43-7070-1

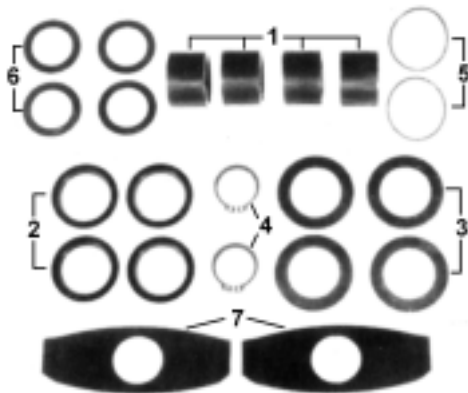

Item No.	Spicer No.	Description	Full Kit Qty.	Half Kit Qty.
1	28-1233	Camshaft Spider Bushing	4	2
2	29-1270	Camshaft Seal	4	2
3	35-1580	Anchor Pin Washer	4	2
4	34-1547	Camshaft Lockring	2	1
5	30-1375	Camshaft Bracket O-Ring	2	1
6	29-1345	Camshaft Washer	4	2
7	29-1339	Camshaft Washer	2	1

- General Information**
- 15" x 4" "Q Plus" Series Brake
 - 1 1/2" Diameter at Spider

NOTE: Full Kit will service one axle
 Half Kit will service one S-camshaft

Rockwell Trailer Axle Brake

Full Kit Number: 43-7071
Half Kit Number: 43-7071-1

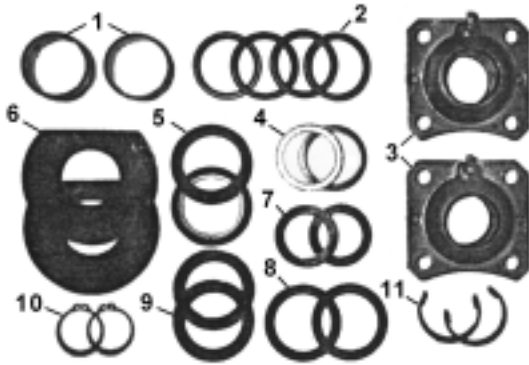

Item No.	Spicer No.	Description	Full Kit Qty.	Half Kit Qty.
1	28-1267	Camshaft Spider Bushing	2	1
2	29-1271	Spider Seal	4	2
3	30-1358	Cam Support Housing	2	1
4	35-1580	Anchor Pin Washer	2	1
5	29-1322	Camshaft Washer	2	1
6	29-1350	Camshaft Washer	2	1
7	29-1351	Camshaft Washer	2	1
8	29-1352	Camshaft Washer	2	1
9	29-1309	Camshaft Washer	2	1
10	34-1525	Camshaft Lockring	2	1
11	29-1324	Camshaft Lockring	2	1

General Information

- 16 1/2" Brake
- 1 5/8" Diameter at Spider
- Forged and Early Model Fabricated Spiders
- Press In Spider Bushing

Rockwell Trailer Axle Brake

Full Kit Number: 43-7072
Half Kit Number: 43-7072-1

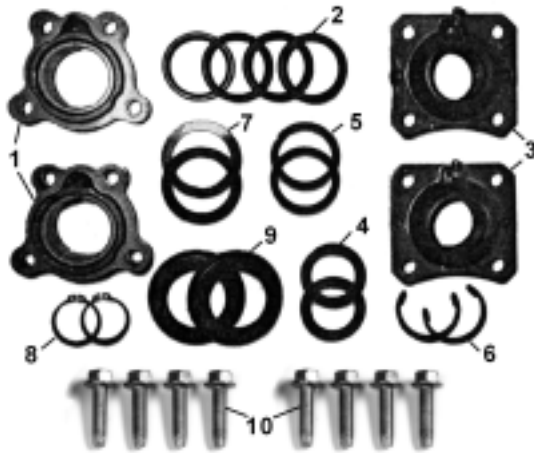

Item No.	Spicer No.	Description	Full Kit Qty.	Half Kit Qty.
1	30-1381	Spider Bushing Assembly	2	1
2	29-1274	Spider Seal	4	2
3	30-1358	Cam Support Housing	2	1
4	29-1351	Camshaft Washer	2	1
5	35-1580	Anchor Pin Washer	2	1
6	29-1324	Camshaft Lockring	2	1
7	29-1353	Camshaft Washer	2	1
8	34-1525	Camshaft Lockring	2	1
9	29-1309	Camshaft Washer	2	1
10	34-1554	Self Tapping Screw	8	4

General Information

- 16 1/2" Brake
- 1 5/8" Diameter at Spider
- Late Model Fabricated Spider
- Bolt-on Bushing

NOTE: Full Kit will service one axle
 Half Kit will service one S-camshaft

Rockwell Trailer Axle Brake

Full Kit Number: 43-7072A
Half Kit Number: 43-7072A-1



Item No.	Spicer No.	Description	Full Kit Qty.	Half Kit Qty.
1	30-1381	Spider Bushing Assembly	2	1
2	34-1554	Self Tapping Screw	8	4
3	29-1353	Camshaft Washer	2	1
4	29-1324	Camshaft Lockring	2	1
5	29-1274	Spider Seal	4	2

- General Information**
- 16 1/2" Brake
 - 1 5/8" Diameter at Spider
 - Late Model Fabricated Spider
 - Bushing Kit for 43-7072

Spicer Steer Axle Brake

Full Kit Number: 43-7080
Half Kit Number: 43-7080-1



Item No.	Spicer No.	Description	Full Kit Qty.	Half Kit Qty.
1	28-1264	Camshaft Bushing	4	2
2	29-1265	Camshaft Seal	4	2

- General Information**
- 15 x 4" Brake
 - 1 1/4" Diameter at Spider

NOTE: Full Kit will service one axle
Half Kit will service one S-camshaft

Spicer Drive Axle Brake

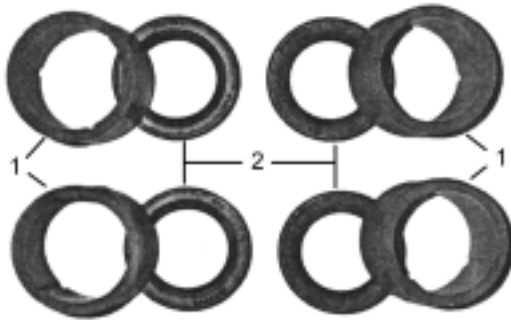

Full Kit Number: 43-7081
Half Kit Number: 43-7081-1

Item No.	Spicer No.	Description	Full Kit Qty.	Half Kit Qty.
1	28-1266	Camshaft Bushing	4	2
2	29-1287	Camshaft Seal	4	2

General Information

- 16 1/2 x 5", 6" and 7" "XL" and "XLII" Brakes
- 1 1/2" Diameter at Spider

Intraax Trailer Axle Brake

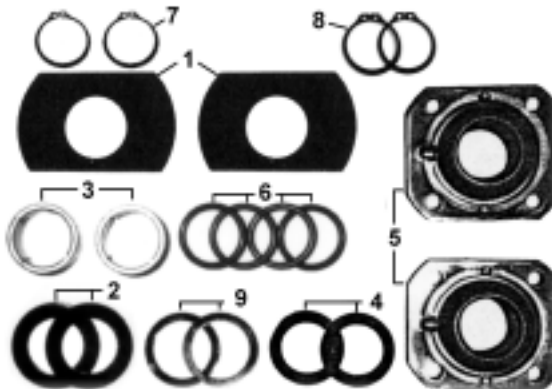

Full Kit Number: 43-7090
Half Kit Number: 43-7090-1

Item No.	Spicer No.	Description	Full Kit Qty.	Half Kit Qty.
1	29-1310	Camshaft Washer	2	1
2	29-1311	Camshaft Washer	2	1
3	28-1231	Camshaft Spider Bushing	2	1
4	35-1580	Anchor Pin Washer	2	1
5	30-1358	Cam Support Housing	2	1
6	29-1269	Spider Seal	4	2
7	29-1306	Camshaft Lockring	2	1
8	34-1563	Anchor Pin Retainer	2	1
9	29-1309	Camshaft Washer	2	1

General Information

- 16 1/2" Brake
- 1 1/2" Diameter at Spider
- Bronze Spider Bushings
- Hendrickson Intraax Suspension System

NOTE: Full Kit will service one axle
 Half Kit will service one S-camshaft

Eaton Trailer Axle Brake

Full Kit Number: 43-7091
Half Kit Number: 43-7091-1

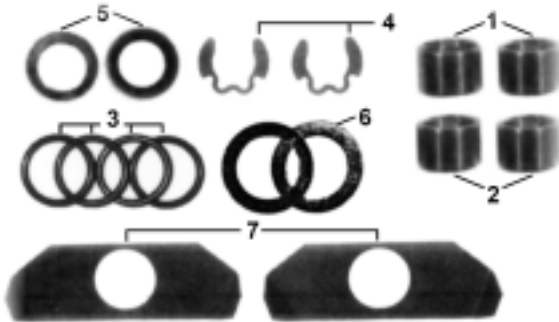

Item No.	Spicer No.	Description	Full Kit Qty.	Half Kit Qty.
1	28-1234	Camshaft Spider Bushing	2	1
2	28-1270	Camshaft Spider Bushing	2	1
3	29-1269	Spider Seal	4	2
4	29-1303	Retainer Snap Ring	2	1
5	29-1321	Camshaft Washer	2	1
6	29-1308	Camshaft Washer	2	1
7	29-1355	Camshaft Washer	2	1

General Information

- 15" x 6" and 15" x 8 5/8" Reduced Envelope Brake
- 1 1/2" Diameter at Spider
- Bronze Spider Bushings

Eaton Trailer Axle Brake

Full Kit Number: 43-7092
Half Kit Number: 43-7092-1

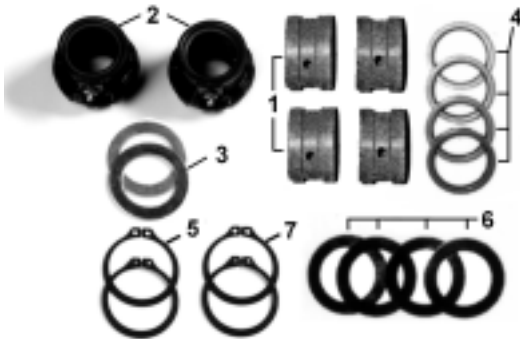

Item No.	Spicer No.	Description	Full Kit Qty.	Half Kit Qty.
1	28-1238	Camshaft Spider Bushing	4	2
2	27-1196	Cam Bracket Bushing	2	1
3	29-1327	Camshaft Washer	2	1
4	29-1271	Spider Seal	4	2
5	29-1305	Camshaft Lockring	2	1
6	29-1308	Camshaft Washer	4	2
7	29-1301	Camshaft Lockring	2	1

General Information

- 15" x 6 1/4" Reduced Envelope Brake
- 1 21/32" Diameter at Spider

NOTE: Full Kit will service one axle
 Half Kit will service one S-camshaft

Rockwell Drive Axle Brake

Full Kit Number: 43-7100
Half Kit Number: 43-7100-1

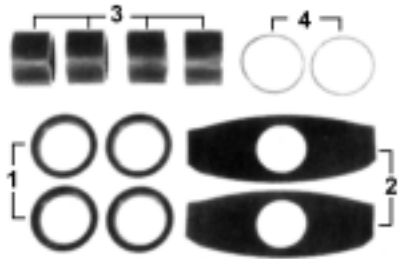

Item No.	Spicer No.	Description	Full Kit Qty.	Half Kit Qty.
1	29-1270	Camshaft Seal	4	2
2	29-1339	Camshaft Washer	2	1
3	28-1233	Camshaft Spider Bushing	4	2
4	27-1203	Camshaft Bushing O-Ring	2	1

General Information

- 16 1/2" x 7" "P", "Q" and "Coach" Brakes
- 1 1/2" Diameter at Spider
- Nylon Spider Bushings

Rockwell Drive Axle Brake

Full Kit Number: 43-7101
Half Kit Number: 43-7101-1

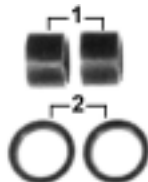

Item No.	Spicer No.	Description	Full Kit Qty.	Half Kit Qty.
1	28-1233	Camshaft Spider Bushing	2	1
2	29-1270	Camshaft Seal	2	1

General Information

- 16 1/2" x 7" "P", "Q" and "Q Plus" Brakes
- 1 1/2" Diameter at Spider
- Nylon Spider Bushings
- Bushing and Seal Kit for 43-7100

NOTE: Full Kit will service one axle
 Half Kit will service one S-camshaft

Rockwell Drive Axle Brake

Full Kit Number: 43-7110
Half Kit Number: 43-7110-1



Item No.	Spicer No.	Description	Full Kit Qty.	Half Kit Qty.
1	28-1252	Camshaft Steel Outer Bushing	2	1
2	28-1253	Camshaft Plastic Inner Bushing	2	1
3	29-1269	Spider Seal	2	1
4	28-1267	Camshaft Spider Bushing	2	1

General Information

- 16 1/2" x 7", 8 5/8" and 10" "P" and "Q" Brakes
- 1 5/8" Diameter at Spider

Eaton Drive Axle Brake

Full Kit Number: 43-7115
Half Kit Number: 43-7115-1

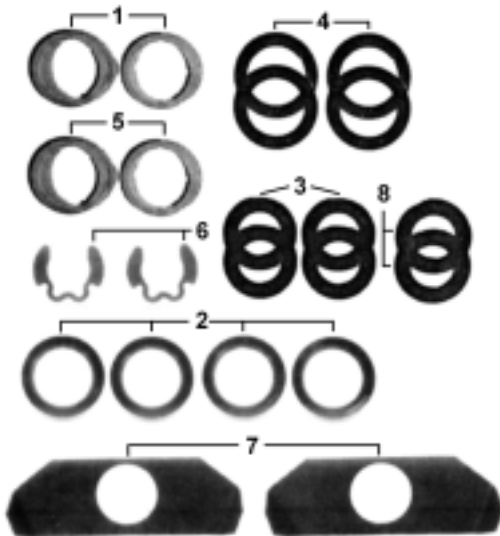

Item No.	Spicer No.	Description	Full Kit Qty.	Half Kit Qty.
1	28-1233	Camshaft Spider Bushing	2	1
2	29-1269	Spider Seal	4	2
3	29-1320	Camshaft Washer	4	2
4	29-1321	Camshaft Washer	4	2
5	28-1234	Camshaft Spider Bushing	2	1
6	29-1303	Retainer Snap Ring	2	1
7	29-1355	Camshaft Washer	2	1
8	29-1307	Camshaft Washer	2	1

General Information

- 16 1/2" and 18" ES™ Brakes
- 1 1/2" Diameter at Spider
- Nylon Spider Bushings

NOTE: Full Kit will service one axle
Half Kit will service one S-camshaft

Spicer Trailer Axle Brake

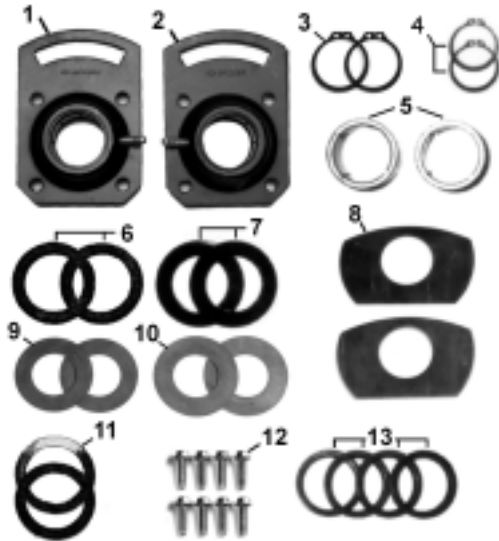

Full Kit Number: 43-7117
Half Kit Number: 43-7117-1

Item No.	Spicer No.	Description	Full Kit Qty.	Half Kit Qty.
1	30-1341L	Cam Bracket Assembly-L	1	1
2	30-1341R	Cam Bracket Assembly-R	1	1
3	29-1301	Camshaft Lockring	2	1
4	34-1525	Camshaft Lockring	2	1
5	28-1231	Camshaft Spider Bushing	2	1
6	29-1307	Camshaft Washer	2	1
7	29-1311	Camshaft Washer	2	1
8	29-1319	Camshaft Washer	2	1
9	29-1362	Camshaft Washer	2	1
10	29-1363	Camshaft Washer	2	1
11	34-1600	Camshaft Washer	2	1
12	34-1567	Self Tapping Screw	8	4
13	29-1208	Spider Seal	4	2

General Information

- 12 1/4" and 16 1/2" Standard and "XL" Brakes
- 1 1/2" Diameter at Spider
- Bronze Spider Bushings

Spicer Trailer Axle Brake

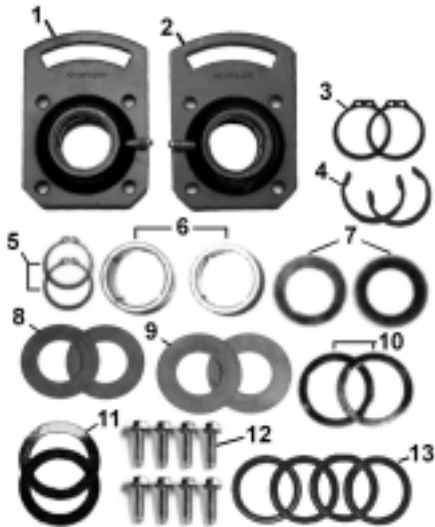

Full Kit Number: 43-7118
Half Kit Number: 43-7118-1

Item No.	Spicer No.	Description	Full Kit Qty.	Half Kit Qty.
1	30-1341L	Cam Bracket Assembly-L	1	1
2	30-1341R	Cam Bracket Assembly-R	1	1
3	29-1301	Camshaft Lockring	2	1
4	29-1324	Camshaft Lockring	2	1
5	34-1525	Camshaft Lockring	2	1
6	28-1242	Camshaft Spider Bushing	2	1
7	29-1361	Camshaft Washer	2	1
8	29-1362	Camshaft Washer	2	1
9	29-1363	Camshaft Washer	2	1
10	29-1364	Camshaft Washer	2	1
11	34-1600	Camshaft Washer	2	1
12	34-1567	Self Tapping Screw	8	4
13	29-1271	Spider Seal	4	2

General Information

- 12 1/4" and 16 1/2" Standard and "XL" Brakes
- 1 5/8" Diameter at Spider
- Bronze Spider Bushings
- New Style Bracket Assembly

NOTE: Full Kit will service one axle
 Half Kit will service one S-camshaft

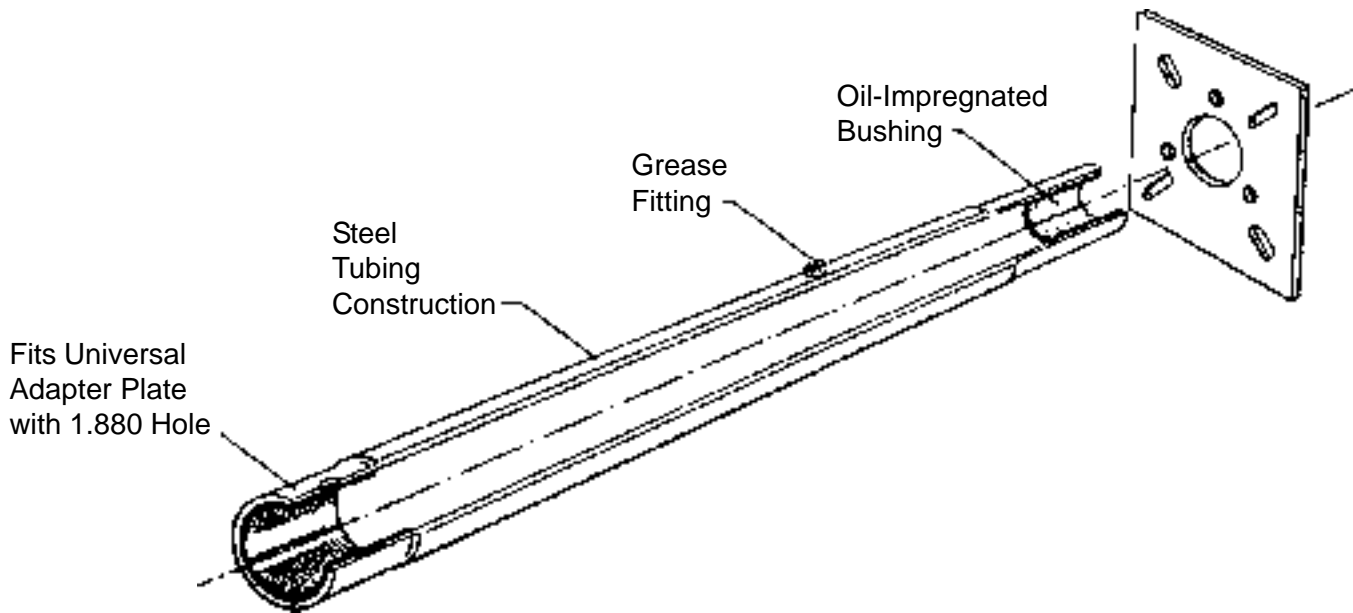

With the fleet requiring and using extended service brake systems, the traditional cam and bushing are failing before the extended service brake lining wears out. The use of a cam enclosure extends the life of the camshaft and its related components to match the life of the extended service brake lining.

All cam enclosures from Spicer are designed to offer superior bearing surfaces for the camshaft. The oil-impregnated bushings are standard and are superior to the soft steel bearing surfaces. The oil-impregnated design reduces wear and increases the life of the camshaft.

Features and Benefits of Spicer Camshaft Enclosures:

Oil-Impregnated Bushing – reduces wear on the camshaft due to galling.

Enclosure Holds A Large Amount of Grease – that can flow more easily to the bearing surfaces, thus extend the life of the camshaft journal and bushings.

Grease Filled Enclosure – extends your maintenance intervals and reduces the likelihood of premature failure from contamination.

Centrally Located Grease Fitting – makes it easier to lube and improves serviceability

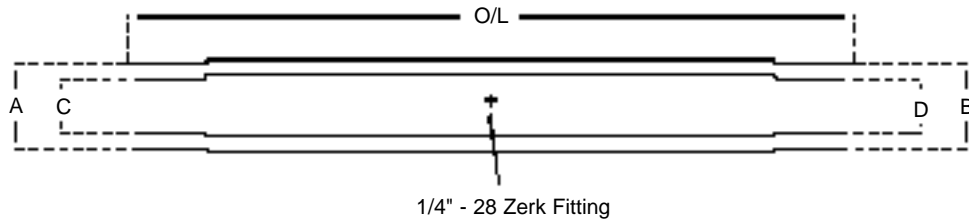

Spicer Number	Inside Diameter	Bracket End	Outside Dia	Overall Length	Camshaft Length	Application
31-1400	1-1/2"	1-1/2"	1-7/8"	14-3/4"	17-3/8"	Special Short Camshaft Spicer & Rockwell Axles
31-1401	1-1/2"	1-1/2"	1-7/8"	17-3/4"	20-3/8"	Standard Length Camshafts Left & Right Hand Spring Suspension
31-1402	1-1/2"	1-1/2"	1-7/8"	21"	23-3/4"	Air Ride Suspensions Spicer & IMT Axles
31-1403	1-1/2"	1-1/2"	1-7/8"	16"	18-5/8"	Chalmers Air Ride Suspension, Spicer, Rockwell, IMT & Eaton Axles
31-1404	1-1/2"	1-1/2"	1-7/8"	19-1/4"	23-3/4"	Chalmers Air Ride Suspension, Spicer Enclosure
31-1410	1-1/2"	1-1/2"	1-7/8"	24"	26-5/8"	Air Ride Suspensions Standard Forge & IMT Axles
31-1411	1-1/2"	1-1/2"	1-7/8"	17-3/4"	20-5/16"	Eaton Lowbed Axle with 12 1/4" Brakes & Small S Head Camshaft
31-1412	1-1/2"	1-1/2"	1-7/8"	20-1/2"	23-1/4"	Spicer Lowbed Axle with Late Model 12 1/4" Brakes
31-1413	1-1/2"	1-1/2"	1-7/8"	18-1/2"	21-1/8"	Spicer Lowbed Axle with Late Model 12 1/4" Brakes
31-1419	1-1/2"	1-1/2"	1-7/8"	19-5/16"	22-1/16"	Spicer 1 1/2" Camshaft, 16 1/2" Brakes
31-1420	1-1/2"	1-1/2"	1-7/8"	23-5/8"	26-1/4"	Air Ride Wide Track Spicer Axles
31-1429	1-1/2"	1-1/2"	1-7/8"	23-7/8"	26-1/16"	Spicer 1 1/2" Camshaft, 16 1/2" Brakes
31-1430	1-5/8"	1-5/8"	2"	13-3/4"	16-1/8"	Fruehauf
31-1431	1-5/8"	1-5/8"	2"	19"	21-1/8"	Fruehauf
31-1432	1-5/8"	1-5/8"	2"	21-1/8"	23-7/8"	Fruehauf
31-1439	1-5/8"	1-1/2"	2"	14-3/16"	17-3/8"	Meritor Cam Enclosures
31-1440	1-5/8"	1-1/2"	2"	18"	20-7/16"	Meritor Axles
31-1441	1-5/8"	1-1/2"	2"	21-5/8"	24-1/8"	Meritor Fabricated Spider
31-1442	1-5/8"	1-1/2"	2"	17"	19-1/2"	Eaton 501 Series, Air Ride, Single Anchor Pin 16 1/2" Brakes
31-1443	1-5/8"	1-1/2"	2"	21"	23-3/4"	Eaton 501 Series, Air Ride, Single Anchor Pin 16 1/2" Brakes
31-1444	1-1/2"	1-1/2"	1-7/8"	23-1/4"	26-1/4"	Spicer 1 1/2" Camshaft, 16 1/2" Brakes
31-1445	1-1/2"	1-1/2"	1-7/8"	8-3/4"	11-1/2"	Spicer 1 1/2" Camshaft, 16 1/2" Brakes
31-1447	1-1/2"	1-1/2"	1-7/8"	6"	9"	Spicer 1 1/2" Camshaft, 12 1/4" Brakes
31-1448	1-1/2"	1-1/2"	1-7/8"	20-1/4"	23-1/4"	Spicer 1 1/2" Camshaft, 12 1/4" Brakes
31-1448AM	1-5/8"	1-1/2"	2"	13-5/8"	17-3/8"	Meritor Axles with Sintered Metal Spider Bracket
31-1449	1-1/2"	1-1/2"	1-7/8"	18-1/2"	21-1/2"	Spicer 1 1/2" Camshaft, 12 1/4" Brakes
31-1449AM	1-5/8"	1-1/2"	2"	16-3/4"	20-7/16"	Meritor Axles with Sintered Metal Spider Bracket
31-1450	1-1/2"	1-1/2"	1-7/8"	3-7/8"	6-1/2"	Spicer 1 1/2" Camshaft, 16 1/2" Brakes
31-1450AM	1-5/8"	1-1/2"	2"	20-1/2"	24-1/8"	Spicer 1 1/2" Camshaft, 16 1/2" Brakes

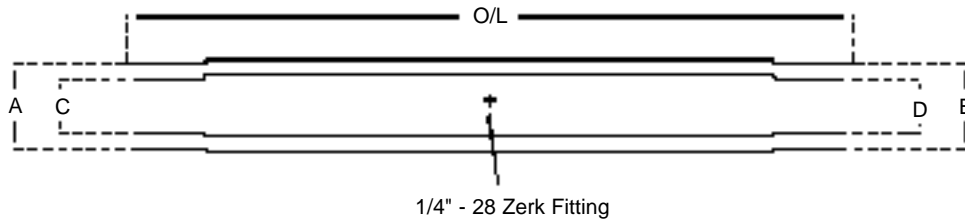

Spicer Number	Inside Diameter	Bracket End	Outside Dia	Overall Length	Camshaft Length	Application
31-1451	1-1/2"	1-1/2"	1-7/8"	2-1/2"	5-1/2"	Spicer 1 1/2" Camshaft, 12 1/4" Brakes
31-1452	1-1/2"	1-1/2"	1-7/8"	26-1/2"	26-1/2"	Spicer 1 1/2" Camshaft, 12 1/4" Brakes
31-1453	1-1/2"	1-1/2"	1-7/8"	15"	17-3/4"	Spicer 1 1/2" Camshaft, 16 1/2" Brakes
31-1455	1-1/2"	1-1/2"	1-7/8"	13-3/4"	16-1/2"	Spicer 1 1/2" Camshaft, 16 1/2" Brakes
31-1456	1-1/2"	1-1/2"	1-7/8"	4-5/8"	7-13/32"	Spicer 1 1/2" Camshaft, 16 1/2" Brakes
31-1457	1-5/8"	1-1/2"	2"	21"	24"	Spicer Axle with 1 5/8" Camshaft, 16 1/2" Brakes
31-1458	1-5/8"	1-1/2"	2"	18-5/8"	21-5/8"	Spicer Axle with 1 5/8" Camshaft, 16 1/2" Brakes
31-1459	1-1/2"	1-1/2"	1-7/8"	5-3/4"	8-1/2"	Spicer 1 1/2" Camshaft, 16 1/2" Brakes
31-1460	1-5/8"	1-1/2"	2"	2-1/2"	5-1/2"	Spicer Axle with 1 5/8" Camshaft, 12 1/4" Brakes
31-1461	1-5/8"	1-1/2"	2"	18-1/2"	21-1/2"	Spicer Axle with 1 5/8" Camshaft, 12 1/4" Brakes
31-1462	1-5/8"	1-1/2"	2"	20-1/4"	23-1/4"	Spicer Axle with 1 5/8" Camshaft, 12 1/4" Brakes
31-1463	1-5/8"	1-1/2"	2"	20-5/8"	23-5/8"	Spicer Axle with 1 5/8" Camshaft, 16 1/2" Brakes
31-1464	1-5/8"	1-1/2"	2"	17-5/8"	20-5/8"	Spicer Axle with 1 5/8" Camshaft, 16 1/2" Brakes
31-1465	1-5/8"	1-1/2"	2"	23-1/2"	26-1/2"	Spicer Axle with 1 5/8" Camshaft, 12 1/4" Brakes
31-1466	1-5/8"	1-1/2"	2"	8-13/16"	11-3-/16"	Hendrickson INTRAAX

Support Bracket Mounting Plate



Part Number	Bracket Dimensions	Camshaft Application
31-1405	4" x 4" x 1/8" thick, 1-7/8" O.D. Cam Enclosure	Universal Bracket: IMT, Spicer & Rockwell Axles
31-1406	3-3/8" x 3-3/8" x 1/8" thick, Meritor 2" O.D. Cam Enclosure	Meritor Bracket
31-1415-1	1-7/8" O.D. Cam Enclosure	Adapter Plate with Haldex Adjuster Control Arm Slot
31-1415-2	2" O.D. Cam Enclosure	Adapter Plate with Haldex Adjuster Control Arm Slot
31-1467	4" x 4" x 1/8" thick, 2" O.D. Cam Enclosure	Fruehauf Propar Bracket
31-1468	4" x 4" x 1/8" thick, 2" O.D. Cam Enclosure	Universal Bracket

CROSS REFERENCE

Manufacturer Number	Manufacturer	Spicer Number	Manufacturer Number	Manufacturer	Spicer Number
034-188-00	Dexter	17-11061	04-037	Batco	18-823
034-188-01	Dexter	17-11057	04-038	Batco	18-866
034-188-03	Dexter	17-11063	04-039	Batco	18-867
034-188-04	Dexter	17-11059	04-040	Batco	18-836
034-188-05	Dexter	17-11065	04-041	Batco	18-837
034-188-09	Dexter	17-11069	04-042	Batco	18-868
034-188-11	Dexter	17-11067	04-043	Batco	18-869
034-189-00	Dexter	17-11062	04-046	Batco	18-832
034-189-01	Dexter	17-11058	04-047	Batco	18-833
034-189-03	Dexter	17-11064	04-050	Batco	18-830
034-189-04	Dexter	17-11060	04-051	Batco	18-831
034-189-05	Dexter	17-11066	04-052	Batco	18-824
034-189-09	Dexter	17-11070	04-053	Batco	18-825
034-189-11	Dexter	17-11068	04-054	Batco	18-828
04-004	Batco	17-480	04-055	Batco	18-829
04-005	Batco	17-481	04-056	Batco	18-860
04-006	Batco	17-484	04-057	Batco	18-861
04-007	Batco	17-485	04-058	Batco	18-826
04-008	Batco	17-482	04-059	Batco	18-827
04-009	Batco	17-483	04-060	Batco	18-864
04-010	Batco	18-760	04-061	Batco	18-865
04-011	Batco	18-761	04-062	Batco	18-850
04-012	Batco	18-762	04-063	Batco	18-851
04-013	Batco	18-763	04-064	Batco	18-780
04-014	Batco	18-766	04-065	Batco	18-781
04-015	Batco	18-767	04-066	Batco	17-714
04-016	Batco	18-768	04-067	Batco	17-715
04-017	Batco	18-769	04-068	Batco	17-702
04-018	Batco	18-770	04-069	Batco	17-703
04-019	Batco	18-771	04-070	Batco	18-911
04-020	Batco	18-772	04-071	Batco	18-910
04-021	Batco	18-773	04-082	Batco	17-610
04-022	Batco	18-774	04-083	Batco	17-611
04-023	Batco	18-775	04-084	Batco	18-900
04-024	Batco	18-776	04-085	Batco	18-901
04-025	Batco	18-777	04-090	Batco	17-700
04-030	Batco	18-834	04-091	Batco	17-701
04-031	Batco	18-835	04-0961	Batco	17-470
04-032	Batco	18-878	04-0971	Batco	17-471
04-033	Batco	18-879	04-0981	Batco	17-472
04-034	Batco	18-820	04-0991	Batco	17-473
04-035	Batco	18-821	04-100	Batco	17-586
04-036	Batco	18-822	04-101	Batco	17-587

CROSS REFERENCE

Manufacturer Number	Manufacturer	Spicer Number	Manufacturer Number	Manufacturer	Spicer Number
04-102	Batco	17-589	04-150861	Batco	18-766
04-103	Batco	17-588	04-150862	Batco	18-767
04-104	Batco	17-575	04-150911	Batco	18-768
04-105	Batco	17-574	04-150912	Batco	18-769
04-106	Batco	17-594	04-150931	Batco	18-770
04-107	Batco	17-595	04-150932	Batco	18-771
04-108	Batco	17-584	04-150961	Batco	18-772
04-109	Batco	17-585	04-150962	Batco	18-773
04-110	Batco	17-582	04-151	Batco	18-809
04-110821	Batco	18-704	04-151001	Batco	18-774
04-110822	Batco	18-705	04-151002	Batco	18-775
04-111	Batco	17-583	04-151111	Batco	18-776
04-116	Batco	17-579	04-151112	Batco	18-777
04-117	Batco	17-578	04-152	Batco	18-804
04-118	Batco	17-566	04-153	Batco	18-805
04-119	Batco	17-567	04-154	Batco	18-816
04-120	Batco	17-576	04-155	Batco	18-817
04-121	Batco	17-577	04-156	Batco	18-784
04-122	Batco	17-573	04-157	Batco	18-785
04-123	Batco	17-572	04-158	Batco	18-802
04-125	Batco	17-560	04-159	Batco	18-803
04-126	Batco	17-561	04-160	Batco	18-801
04-132	Batco	17-590	04-160761	Batco	18-960
04-133	Batco	17-591	04-160762	Batco	18-961
04-134	Batco	17-592	04-160811	Batco	18-962
04-135	Batco	17-593	04-160812	Batco	18-963
04-136	Batco	17-570	04-160831	Batco	18-964
04-137	Batco	17-571	04-160832	Batco	18-965
04-140	Batco	18-819	04-160841	Batco	18-966
04-141	Batco	18-818	04-160842	Batco	18-967
04-142	Batco	18-790	04-160861	Batco	18-968
04-143	Batco	18-791	04-160862	Batco	18-969
04-144	Batco	18-812	04-160911	Batco	18-970
04-145	Batco	18-813	04-160912	Batco	18-971
04-146	Batco	18-810	04-160931	Batco	18-972
04-147	Batco	18-811	04-160932	Batco	18-973
04-148	Batco	18-786	04-160961	Batco	18-974
04-149	Batco	18-787	04-160962	Batco	18-975
04-150	Batco	18-808	04-161	Batco	18-800
04-150761	Batco	18-760	04-161001	Batco	18-976
04-150762	Batco	18-761	04-161001	Batco	18-978
04-150811	Batco	18-762	04-161002	Batco	18-977
04-150812	Batco	18-763	04-161002	Batco	18-979

CROSS REFERENCE

Manufacturer Number	Manufacturer	Spicer Number	Manufacturer Number	Manufacturer	Spicer Number
04-161111	Batco	18-978	04-200961	Batco	18-958
04-161112	Batco	18-979	04-200962	Batco	18-959
04-161121	Batco	18-980	04-201	Batco	17-599
04-161122	Batco	18-981	04-202	Batco	17-634
04-162	Batco	18-814	04-203	Batco	17-635
04-163	Batco	18-815	04-204	Batco	17-636
04-164	Batco	18-807	04-205	Batco	17-637
04-165	Batco	18-806	04-206	Batco	17-638
04-168	Batco	18-852	04-207	Batco	17-639
04-169	Batco	18-853	04-210811	Batco	18-890
04-170	Batco	18-854	04-210812	Batco	18-891
04-171	Batco	18-855	04-210851	Batco	18-892
04-172	Batco	18-812	04-210852	Batco	18-893
04-173	Batco	18-813	04-210931	Batco	18-896
04-180	Batco	18-842	04-210932	Batco	18-897
04-181	Batco	18-843	04-210961	Batco	18-900
04-182	Batco	18-840	04-210962	Batco	18-901
04-183	Batco	18-841	04-222	Batco	17-682
04-186	Batco	18-846	04-223	Batco	17-683
04-187	Batco	18-847	04-230	Batco	17-640
04-188	Batco	18-844	04-230941	Batco	18-906
04-189	Batco	18-845	04-230942	Batco	18-907
04-190	Batco	18-880	04-231	Batco	17-641
04-190811	Batco	18-856	04-232	Batco	17-642
04-190812	Batco	18-857	04-233	Batco	17-643
04-190851	Batco	18-858	04-234	Batco	17-632
04-190852	Batco	18-859	04-235	Batco	17-633
04-190931	Batco	18-872	04-240	Batco	17-698
04-190931	Batco	18-956	04-240571	Batco	18-840
04-190932	Batco	18-873	04-240572	Batco	18-841
04-190932	Batco	18-957	04-240761	Batco	18-842
04-191	Batco	18-881	04-240762	Batco	18-843
04-192	Batco	18-856	04-240811	Batco	18-844
04-193	Batco	18-857	04-240812	Batco	18-845
04-194	Batco	18-858	04-240831	Batco	18-846
04-195	Batco	18-859	04-240832	Batco	18-847
04-196	Batco	18-872	04-240901	Batco	18-880
04-197	Batco	18-873	04-240902	Batco	18-881
04-200	Batco	17-598	04-241	Batco	17-699
04-200771	Batco	18-954	04-242	Batco	17-580
04-200772	Batco	18-955	04-243	Batco	17-581
04-200811	Batco	18-950	04-254	Batco	18-742
04-200812	Batco	18-951	04-255	Batco	18-743

CROSS REFERENCE

Manufacturer Number	Manufacturer	Spicer Number	Manufacturer Number	Manufacturer	Spicer Number
04-256	Batco	18-730	04-370862	Batco	18-727
04-257	Batco	18-731	04-370901	Batco	18-728
04-258	Batco	18-732	04-370902	Batco	18-729
04-259	Batco	18-733	04-370971	Batco	18-730
04-260	Batco	18-728	04-370972	Batco	18-731
04-260931	Batco	18-936	04-371021	Batco	18-732
04-260932	Batco	18-937	04-371022	Batco	18-733
04-261	Batco	18-729	04-371051	Batco	18-734
04-262	Batco	18-736	04-371052	Batco	18-735
04-263	Batco	18-737	04-371121	Batco	18-736
04-264	Batco	18-739	04-371122	Batco	18-737
04-265	Batco	18-738	04-371151	Batco	18-738
04-266	Batco	18-726	04-371152	Batco	18-739
04-267	Batco	18-727	04-371251	Batco	18-740
04-268	Batco	18-740	04-371252	Batco	18-741
04-269	Batco	18-741	04-371311	Batco	18-748
04-270	Batco	18-734	04-371312	Batco	18-749
04-271	Batco	18-735	04-371351	Batco	18-742
04-272	Batco	18-748	04-371352	Batco	18-743
04-273	Batco	18-749	04-371431	Batco	18-746
04-274	Batco	18-746	04-371432	Batco	18-747
04-275	Batco	18-747	04-371461	Batco	18-754
04-276	Batco	18-736	04-371462	Batco	18-755
04-277	Batco	18-737	04-390861	Batco	18-940
04-278	Batco	17-620	04-390862	Batco	18-941
04-279	Batco	17-621	04-391051	Batco	18-982
04-280	Batco	17-622	04-391052	Batco	18-983
04-281	Batco	17-623	04-391161	Batco	18-942
04-282	Batco	17-614	04-391162	Batco	18-943
04-283	Batco	17-615	04-391251	Batco	18-984
04-286	Batco	17-618	04-391252	Batco	18-985
04-287	Batco	17-619	04-391441	Batco	18-944
04-290	Batco	17-624	04-391442	Batco	18-945
04-291	Batco	17-625	04-400	Batco	18-930
04-292	Batco	17-626	04-401	Batco	18-931
04-293	Batco	17-627	04-450	Batco	17-720
04-294	Batco	17-630	04-450521	Batco	18-792
04-295	Batco	17-631	04-450522	Batco	18-793
04-296	Batco	17-628	04-450651	Batco	18-800
04-297	Batco	17-629	04-450652	Batco	18-801
04-321221	Batco	18-708	04-450811	Batco	18-802
04-321222	Batco	18-709	04-450812	Batco	18-803
04-370861	Batco	18-726	04-450821	Batco	18-854

CROSS REFERENCE

Manufacturer Number	Manufacturer	Spicer Number	Manufacturer Number	Manufacturer	Spicer Number
04-450822	Batco	18-855	04-460922	Batco	18-851
04-450861	Batco	18-804	04-460951	Batco	18-508
04-450862	Batco	18-805	04-460951	Batco	18-864
04-450921	Batco	18-794	04-460952	Batco	18-509
04-450922	Batco	18-795	04-460952	Batco	18-865
04-451	Batco	17-721	04-461031	Batco	18-710
04-451031	Batco	18-784	04-461031	Batco	18-930
04-451032	Batco	18-785	04-461032	Batco	18-711
04-451051	Batco	18-806	04-461032	Batco	18-931
04-451052	Batco	18-807	04-461051	Batco	18-510
04-451121	Batco	18-808	04-461051	Batco	18-826
04-451122	Batco	18-809	04-461052	Batco	18-511
04-451151	Batco	18-810	04-461052	Batco	18-827
04-451152	Batco	18-811	04-461101	Batco	18-514
04-451171	Batco	18-786	04-461101	Batco	18-828
04-451172	Batco	18-787	04-461102	Batco	18-515
04-451221	Batco	18-852	04-461102	Batco	18-829
04-451222	Batco	18-853	04-461121	Batco	18-516
04-451251	Batco	18-812	04-461121	Batco	18-830
04-451252	Batco	18-813	04-461122	Batco	18-517
04-451311	Batco	18-814	04-461122	Batco	18-831
04-451312	Batco	18-815	04-461151	Batco	18-518
04-451371	Batco	18-724	04-461151	Batco	18-832
04-451372	Batco	18-725	04-461152	Batco	18-519
04-451421	Batco	18-816	04-461152	Batco	18-833
04-451422	Batco	18-817	04-461161	Batco	18-520
04-451501	Batco	18-790	04-461161	Batco	18-866
04-451502	Batco	18-791	04-461162	Batco	18-521
04-451561	Batco	18-818	04-461162	Batco	18-867
04-451562	Batco	18-819	04-461251	Batco	18-524
04-452	Batco	17-722	04-461251	Batco	18-868
04-453	Batco	17-723	04-461252	Batco	18-525
04-454	Batco	17-724	04-461252	Batco	18-869
04-455	Batco	17-725	04-461311	Batco	18-526
04-460821	Batco	18-502	04-461311	Batco	18-530
04-460821	Batco	18-860	04-461311	Batco	18-836
04-460822	Batco	18-503	04-461312	Batco	18-527
04-460822	Batco	18-861	04-461312	Batco	18-531
04-460851	Batco	18-504	04-461312	Batco	18-837
04-460851	Batco	18-824	04-461331	Batco	18-528
04-460852	Batco	18-505	04-461331	Batco	18-820
04-460852	Batco	18-825	04-461332	Batco	18-529
04-460921	Batco	18-850	04-461332	Batco	18-821

CROSS REFERENCE

Manufacturer Number	Manufacturer	Spicer Number	Manufacturer Number	Manufacturer	Spicer Number
04-461351	Batco	18-532	04-481532	Batco	18-541
04-461351	Batco	18-822	04-506	Batco	17-656
04-461352	Batco	18-533	04-507	Batco	17-657
04-461352	Batco	18-823	04-508	Batco	17-658
04-461421	Batco	18-534	04-509	Batco	17-659
04-461421	Batco	18-834	04-510	Batco	17-660
04-461422	Batco	18-535	04-511	Batco	17-661
04-461422	Batco	18-835	04-524	Batco	18-940
04-461511	Batco	18-878	04-525	Batco	18-941
04-461512	Batco	18-879	04-530	Batco	18-942
04-461531	Batco	18-540	04-531	Batco	18-943
04-461531	Batco	18-712	04-534	Batco	18-944
04-461532	Batco	18-541	04-535	Batco	18-945
04-461532	Batco	18-713	04-560	Batco	17-568
04-461551	Batco	18-714	04-561	Batco	17-569
04-461552	Batco	18-715	04-562	Batco	17-580
04-480	Batco	18-958	04-563	Batco	17-581
04-480771	Batco	18-500	04-566	Batco	17-594
04-480772	Batco	18-501	04-567	Batco	17-595
04-481	Batco	18-959	04-568	Batco	17-574
04-481031	Batco	18-930	04-569	Batco	17-575
04-481032	Batco	18-931	04-570	Batco	17-506
04-481041	Batco	18-510	04-570741	Batco	17-610
04-481042	Batco	18-511	04-570742	Batco	17-611
04-481051	Batco	18-512	04-571	Batco	17-507
04-481052	Batco	18-513	04-571561	Batco	17-560
04-481121	Batco	18-516	04-571562	Batco	17-561
04-481122	Batco	18-517	04-571631	Batco	17-570
04-481151	Batco	18-518	04-571632	Batco	17-571
04-481152	Batco	18-519	04-571651	Batco	17-576
04-481211	Batco	18-522	04-571652	Batco	17-577
04-481212	Batco	18-523	04-571741	Batco	17-568
04-481331	Batco	18-528	04-571742	Batco	17-569
04-481332	Batco	18-529	04-571761	Batco	17-572
04-481341	Batco	18-530	04-571762	Batco	17-573
04-481342	Batco	18-531	04-571861	Batco	17-578
04-481351	Batco	18-532	04-571862	Batco	17-579
04-481352	Batco	18-533	04-572041	Batco	17-580
04-481421	Batco	18-534	04-572042	Batco	17-581
04-481422	Batco	18-535	04-572111	Batco	17-582
04-481471	Batco	18-538	04-572112	Batco	17-583
04-481472	Batco	18-539	04-572241	Batco	17-584
04-481531	Batco	18-540	04-572242	Batco	17-585

CROSS REFERENCE

Manufacturer Number	Manufacturer	Spicer Number	Manufacturer Number	Manufacturer	Spicer Number
04-572301	Batco	17-594	04-592472	Batco	17-535
04-572302	Batco	17-595	04-601741	Batco	17-512
04-572351	Batco	17-574	04-601742	Batco	17-513
04-572352	Batco	17-575	04-602041	Batco	17-500
04-572411	Batco	17-586	04-602042	Batco	17-501
04-572412	Batco	17-587	04-602301	Batco	17-510
04-572441	Batco	17-588	04-602302	Batco	17-511
04-572442	Batco	17-589	04-602351	Batco	17-502
04-572571	Batco	17-596	04-602352	Batco	17-503
04-572572	Batco	17-597	04-602401	Batco	17-490
04-572651	Batco	17-592	04-602402	Batco	17-491
04-572652	Batco	17-593	04-602411	Batco	17-514
04-578	Batco	17-522	04-602412	Batco	17-515
04-579	Batco	17-523	04-602601	Batco	17-492
04-580	Batco	17-512	04-602602	Batco	17-493
04-581	Batco	17-513	04-602701	Batco	17-522
04-581741	Batco	17-478	04-602702	Batco	17-523
04-581742	Batco	17-479	04-611901	Batco	17-676
04-582	Batco	17-500	04-611902	Batco	17-677
04-582041	Batco	17-480	04-612051	Batco	17-680
04-582042	Batco	17-481	04-612052	Batco	17-681
04-582271	Batco	17-484	04-612121	Batco	17-684
04-582272	Batco	17-485	04-612122	Batco	17-685
04-582351	Batco	17-482	04-612211	Batco	17-692
04-582352	Batco	17-483	04-612212	Batco	17-693
04-583	Batco	17-501	04-612321	Batco	17-690
04-584	Batco	17-514	04-612322	Batco	17-691
04-585	Batco	17-515	04-612401	Batco	17-694
04-586	Batco	17-510	04-612402	Batco	17-695
04-587	Batco	17-511	04-612461	Batco	17-648
04-588	Batco	17-502	04-612462	Batco	17-649
04-589	Batco	17-503	04-612521	Batco	17-706
04-591741	Batco	17-516	04-612522	Batco	17-707
04-591742	Batco	17-517	04-612651	Batco	17-696
04-592041	Batco	17-580	04-612652	Batco	17-697
04-592042	Batco	17-581	04-614	Batco	17-660
04-592301	Batco	17-518	04-615	Batco	17-661
04-592302	Batco	17-519	04-631322	Batco	17-739
04-592351	Batco	17-508	04-631621	Batco	17-734
04-592352	Batco	17-509	04-631622	Batco	17-735
04-592411	Batco	17-506	04-631741	Batco	17-736
04-592412	Batco	17-507	04-631742	Batco	17-737
04-592471	Batco	17-534	04-631811	Batco	17-740

CROSS REFERENCE

Manufacturer Number	Manufacturer	Spicer Number	Manufacturer Number	Manufacturer	Spicer Number
04-631812	Batco	17-741	04-665	Batco	18-975
04-631901	Batco	17-744	04-666	Batco	18-976
04-631902	Batco	17-745	04-667	Batco	18-977
04-632051	Batco	17-750	04-668	Batco	18-978
04-632052	Batco	17-751	04-669	Batco	18-979
04-632131	Batco	17-660	04-670	Batco	18-980
04-632131	Batco	17-754	04-671	Batco	18-981
04-632132	Batco	17-661	04-682411	Batco	17-672
04-632132	Batco	17-755	04-682412	Batco	17-673
04-632211	Batco	17-756	04-711951	Batco	17-634
04-632212	Batco	17-757	04-711952	Batco	17-635
04-632321	Batco	17-738	04-712371	Batco	17-636
04-632321	Batco	17-760	04-712372	Batco	17-637
04-632322	Batco	17-761	04-722021	Batco	17-638
04-632401	Batco	17-764	04-722022	Batco	17-639
04-632402	Batco	17-765	04-730	Batco	18-936
04-632531	Batco	17-768	04-731	Batco	18-937
04-632532	Batco	17-769	04-731941	Batco	17-460
04-632631	Batco	17-770	04-731942	Batco	17-461
04-632632	Batco	17-771	04-732361	Batco	17-462
04-642041	Batco	17-794	04-732362	Batco	17-463
04-642042	Batco	17-795	04-741941	Batco	17-470
04-642131	Batco	17-786	04-741942	Batco	17-471
04-642132	Batco	17-787	04-742361	Batco	17-472
04-642211	Batco	17-796	04-742362	Batco	17-473
04-642212	Batco	17-797	04-772041	Batco	17-11072
04-642321	Batco	17-782	04-772042	Batco	17-11071
04-642322	Batco	17-783	04-782031	Batco	17-682
04-650	Batco	18-960	04-782032	Batco	17-683
04-651	Batco	18-961	04-782231	Batco	17-698
04-652	Batco	18-962	04-782232	Batco	17-699
04-653	Batco	18-963	04-811621	Batco	17-620
04-654	Batco	18-964	04-811622	Batco	17-621
04-655	Batco	18-965	04-812121	Batco	17-622
04-656	Batco	18-966	04-812122	Batco	17-623
04-657	Batco	18-967	04-812401	Batco	17-616
04-658	Batco	18-968	04-812402	Batco	17-617
04-659	Batco	18-969	04-821621	Batco	17-614
04-660	Batco	18-970	04-821622	Batco	17-615
04-661	Batco	18-971	04-831621	Batco	17-624
04-662	Batco	18-972	04-831622	Batco	17-625
04-663	Batco	18-973	04-832121	Batco	17-618
04-664	Batco	18-974	04-832122	Batco	17-619

Manufacturer Number	Manufacturer	Spicer Number	Manufacturer Number	Manufacturer	Spicer Number
04-832421	Batco	17-724	04-942042	Batco	17-715
04-881731	Batco	17-640	04-952041	Batco	17-700
04-881732	Batco	17-641	04-952042	Batco	17-701
04-882041	Batco	17-632	04-952331	Batco	17-702
04-882042	Batco	17-633	04-952332	Batco	17-703
04-882421	Batco	17-642	08-1301	Batco	43-7044
04-882422	Batco	17-643	08-1302	Batco	43-7034
04-891731	Batco	17-626	08-1304	Batco	43-7046
04-891731	Batco	17-720	08-1305	Batco	43-7046A
04-891731	Batco	17-810	08-1306	Batco	43-7037
04-891732	Batco	17-627	08-130600	Batco	43-7037
04-891732	Batco	17-721	08-130601	Batco	43-7037A
04-891732	Batco	17-811	08-130602	Batco	43-7037B
04-892041	Batco	17-628	08-130607	Batco	43-7071
04-892041	Batco	17-722	08-130611	Batco	43-7072
04-892041	Batco	17-812	08-1308	Batco	43-7042
04-892042	Batco	17-629	08-1311	Batco	43-7044A
04-892042	Batco	17-723	08-1318	Batco	43-7048
04-892042	Batco	17-813	08-131800	Batco	43-7048
04-892421	Batco	17-630	08-131804	Batco	43-7070
04-892421	Batco	17-814	08-1321	Batco	43-7032
04-892422	Batco	17-631	08-1323	Batco	43-7062
04-892422	Batco	17-725	08-1324	Batco	43-7029
04-892422	Batco	17-815	08-1326	Batco	43-7032A
04-911731	Batco	17-656	08-1330	Batco	43-7038
04-911731	Batco	17-720	08-1331	Batco	43-7039
04-911732	Batco	17-657	08-1341	Batco	43-7031
04-911732	Batco	17-721	08-1351	Batco	43-7041
04-912041	Batco	17-658	08-1352	Batco	43-7069
04-912041	Batco	17-722	08-1353	Batco	43-7068
04-912042	Batco	17-659	08-1361	Batco	43-7059
04-912042	Batco	17-723	08-1366	Batco	43-7040
04-912421	Batco	17-660	08-1368	Batco	43-7050
04-912421	Batco	17-724	08-1369	Batco	43-7051
04-912422	Batco	17-661	08-1370	Batco	43-7053A
04-912422	Batco	17-725	08-1375	Batco	43-7060
04-931731	Batco	17-720	08-1378	Batco	43-7064
04-931732	Batco	17-721	08-1379	Batco	43-7065
04-932041	Batco	17-722	1000087	Eaton	18-727
04-932042	Batco	17-723	1000088	Eaton	18-726
04-932421	Batco	17-724	1000839	Eaton	18-749
04-932422	Batco	17-725	1000840	Eaton	18-748
04-942041	Batco	17-714	1001580	Eaton	18-747

CROSS REFERENCE

Manufacturer Number	Manufacturer	Spicer Number	Manufacturer Number	Manufacturer	Spicer Number
1001581	Eaton	18-746	130910	Eaton	43-7060
1001722	Eaton	18-751	142923R1	Navistar	18-729
1001723	Eaton	18-750	142924R1	Navistar	18-728
1006724	Eaton	18-761	150543R1	Navistar	18-802
1006725	Eaton	18-760	150544R1	Navistar	18-803
1006726	Eaton	18-763	150WK102-1	Spicer OE	18-621
1006727	Eaton	18-762	150WK102-2	Spicer OE	18-631
1006728	Eaton	18-773	150WK102-3	Spicer OE	18-629
1006729	Eaton	18-772	150WK102-4	Spicer OE	18-625
1006730	Eaton	18-767	150WK102-5	Spicer OE	18-623
1006731	Eaton	18-766	150WK102-6	Spicer OE	18-627
1006864	Eaton	18-777	150WK102-7	Spicer OE	18-635
1006865	Eaton	18-776	150WK103-1	Spicer OE	18-620
1006866	Eaton	18-771	150WK103-2	Spicer OE	18-630
1006867	Eaton	18-770	150WK103-3	Spicer OE	18-628
1006940	Eaton	18-775	150WK103-4	Spicer OE	18-624
1006941	Eaton	18-774	150WK103-5	Spicer OE	18-622
1006948	Eaton	18-765	150WK103-6	Spicer OE	18-626
1006949	Eaton	18-764	150WK103-7	Spicer OE	18-634
1008006	Eaton	18-769	153156R1	Navistar	17-643
1008007	Eaton	18-768	16395	Spicer OE	17-586
1008047	Eaton	43-7068	16396	Spicer OE	17-587
1008246	Eaton	18-779	16407	Spicer OE	17-518
1008247	Eaton	18-778	16407	Spicer OE	17-594
108585R1	Navistar	18-745	16408	Spicer OE	17-519
108586R1	Navistar	18-744	16408	Spicer OE	17-595
109112R1	Navistar	18-743	1646807C1	Navistar	18-827
109113R	Navistar	18-742	1646808C1	Navistar	18-826
110541R1	Navistar	18-842	1658922C91	Navistar	18-901
110542R1	Navistar	18-843	1658923C91	Navistar	18-900
125030	Eaton	17-637	165WK104-1	Spicer OE	18-650
125031	Eaton	17-636	165WK104-11	Spicer OE	18-660
125034	Eaton	17-635	165WK104-13	Spicer OE	18-648
125035	Eaton	17-634	165WK104-2	Spicer OE	18-644
125042	Eaton	17-639	165WK104-3	Spicer OE	18-656
125043	Eaton	17-638	165WK104-4	Spicer OE	18-642
127623	Eaton	43-7044	165WK104-5	Spicer OE	18-654
127988	Eaton	43-7034	165WK104-6	Spicer OE	18-658
128353	Eaton	43-7037	165WK104-7	Spicer OE	18-652
128719	Eaton	43-7044A	165WK104-8	Spicer OE	18-640
129084	Eaton	43-7048	165WK104-9	Spicer OE	18-646
129814	Eaton	43-7030	165WK105-1	Spicer OE	18-651
130545	Eaton	43-7039	165WK105-11	Spicer OE	18-661

Manufacturer Number	Manufacturer	Spicer Number	Manufacturer Number	Manufacturer	Spicer Number
165WK105-13	Spicer OE	18-649	179517	Eaton	18-808
165WK105-2	Spicer OE	18-645	179883	Eaton	18-809
165WK105-3	Spicer OE	18-657	180248	Eaton	18-810
165WK105-4	Spicer OE	18-643	180613	Eaton	18-811
165WK105-5	Spicer OE	18-655	180978	Eaton	18-738
165WK105-6	Spicer OE	18-659	181344	Eaton	18-739
165WK105-7	Spicer OE	18-653	182439	Eaton	18-740
165WK105-8	Spicer OE	18-641	182805	Eaton	18-741
165WK105-9	Spicer OE	18-647	183170	Eaton	17-576
165WK110-1	Spicer OE	18-677	183535	Eaton	17-577
165WK110-11	Spicer OE	18-673	183900	Eaton	17-578
165WK110-12	Spicer OE	18-671	184266	Eaton	17-579
165WK110-13	Spicer OE	18-675	184631	Eaton Top Spec	17-578
165WK110-14	Spicer OE	18-679	184996	Eaton Top Spec	17-579
165WK110-16	Spicer OE	18-689	185361	Eaton	17-635
165WK110-3	Spicer OE	18-681	185727	Eaton	17-634
165WK110-4	Spicer OE	18-683	186092	Eaton	17-682
165WK110-9	Spicer OE	18-685	186457	Eaton	17-683
165WK111-1	Spicer OE	18-676	186822	Eaton	17-580
165WK111-11	Spicer OE	18-672	187188	Eaton	17-581
165WK111-12	Spicer OE	18-670	188283	Eaton Top Spec	17-633
165WK111-13	Spicer OE	18-674	188649	Eaton Top Spec	17-632
165WK111-14	Spicer OE	18-678	189014	Eaton Top Spec	17-582
165WK111-16	Spicer OE	18-688	189379	Eaton Top Spec	17-583
165WK111-3	Spicer OE	18-680	190475	Eaton	17-698
165WK111-4	Spicer OE	18-682	190840	Eaton	17-699
165WK111-9	Spicer OE	18-684	191936	Eaton Top Spec	17-574
16617	Midland	17-572	192301	Eaton Top Spec	17-575
16618	Midland	17-573	192666	Eaton Top Spec	17-694
1676293C1	Navistar	17-628	193032	Eaton Top Spec	17-695
1676294C1	Navistar	17-629	194127	Eaton Top Spec	17-588
1677244C1	Navistar	18-893	194493	Eaton Top Spec	17-589
1677245C1	Navistar	18-892	194858	Eaton	18-517
1685657C1	Navistar	18-859	194858	Eaton	18-831
1685658C1	Navistar	18-858	195223	Eaton	18-516
172247R1	Navistar	18-733	195223	Eaton	18-830
172248R1	Navistar	18-732	195588	Eaton	18-519
1741269	White	18-738	195588	Eaton	18-833
1741270	White	18-739	195954	Eaton	18-518
178056	Eaton	18-804	195954	Eaton	18-832
178422	Eaton	18-805	196319	Eaton	17-626
178787	Eaton	18-727	196319	Eaton	17-811
179152	Eaton	18-726	196684	Eaton	17-627

CROSS REFERENCE

Manufacturer Number	Manufacturer	Spicer Number	Manufacturer Number	Manufacturer	Spicer Number
196684	Eaton	17-810	202103-206L	Std. Forge	17-681
197049	Eaton	17-628	202103-206R	Std. Forge	17-680
197049	Eaton	17-812	202103-213L	Std. Forge	17-685
197415	Eaton	17-629	202103-213R	Std. Forge	17-684
197415	Eaton	17-813	202103-222L	Std. Forge	17-693
197780	Eaton	17-630	202103-222R	Std. Forge	17-692
197780	Eaton	17-814	202103-233L	Std. Forge	17-691
198145	Eaton	17-631	202103-233R	Std. Forge	17-690
198145	Eaton	17-815	202103-241L	Std. Forge	17-695
198510	Eaton	17-621	202103-241R	Std. Forge	17-694
198876	Eaton	17-620	202103-247L	Std. Forge	17-649
199971	Eaton	17-623	202103-247R	Std. Forge	17-648
200337	Eaton	17-622	202103-253L	Std. Forge	17-707
202100-157L	Std. Forge	17-561	202103-253R	Std. Forge	17-706
202100-157R	Std. Forge	17-560	202977R1	Navistar	18-846
202100-166L	Std. Forge	17-577	202978R1	Navistar	18-847
202100-166R	Std. Forge	17-576	203-2000	Manac	18-738
202100-175L	Std. Forge	17-569	203-2006	Manac	17-682
202100-175R	Std. Forge	17-568	203-2007	Manac	17-683
202100-177L	Std. Forge	17-573	203-204	Manac	17-696
202100-177R	Std. Forge	17-572	203-205	Manac	17-697
202100-185L	Std. Forge	17-567	203-2093	Manac	17-588
202100-185R	Std. Forge	17-566	203-2094	Manac	17-589
202100-187L	Std. Forge	17-579	207184R1	Navistar	18-810
202100-187R	Std. Forge	17-578	207185R1	Navistar	18-811
202100-205L	Std. Forge	17-581	212085R1	Navistar	18-808
202100-205R	Std. Forge	17-580	212086R1	Navistar	18-809
202100-213L	Std. Forge	17-583	219316	Fruehauf	17-581
202100-213R	Std. Forge	17-582	219317	Fruehauf	17-580
202100-225L	Std. Forge	17-585	2210-A-2556	Meritor / Rockwell	17-577
202100-225R	Std. Forge	17-584	2210-A-3225	Meritor / Rockwell	18-807
202100-236L	Std. Forge	17-575	2210-A-4265	Meritor / Rockwell	18-795
202100-236R	Std. Forge	17-574	2210-A-4837	Meritor / Rockwell	18-848
202100-242L	Std. Forge	17-587	2210-A-5019	Meritor / Rockwell	18-859
202100-242R	Std. Forge	17-586	2210-A-5019	Meritor / Rockwell	18-953
202100-245L	Std. Forge	17-589	2210-A-5097	Meritor / Rockwell	18-533
202100-245R	Std. Forge	17-588	2210-A-5097	Meritor / Rockwell	18-823
202101-205L	Std. Forge	17-671	2210-A-5123	Meritor / Rockwell	18-504
202101-205R	Std. Forge	17-670	2210-A-5123	Meritor / Rockwell	18-824
202101-242L	Std. Forge	17-673	2210-A-5149	Meritor / Rockwell	17-520
202101-242R	Std. Forge	17-672	2210-A-5331	Meritor / Rockwell	18-518
202103-191L	Std. Forge	17-677	2210-A-5331	Meritor / Rockwell	18-832
202103-191R	Std. Forge	17-676	2210-A-5331S	Meritor / Rockwell	18-832

Manufacturer Number	Manufacturer	Spicer Number	Manufacturer Number	Manufacturer	Spicer Number
2210-A-5357	Meritor / Rockwell	18-812	2210-B-7594	Meritor / Rockwell	18-528
2210-A-5409	Meritor / Rockwell	18-847	2210-C-3097	Meritor / Rockwell	18-852
2210-A-5409S	Meritor / Rockwell	18-847	2210-C-4683	Meritor / Rockwell	18-844
2210-A-5721	Meritor / Rockwell	18-800	2210-C-5021	Meritor / Rockwell	18-955
2210-A-5721S	Meritor / Rockwell	18-800	2210-C-5125	Meritor / Rockwell	18-526
2210-A-5747	Meritor / Rockwell	18-845	2210-C-5125	Meritor / Rockwell	18-836
2210-A-5747S	Meritor / Rockwell	18-845	2210-C-5333	Meritor / Rockwell	18-528
2210-A-6007	Meritor / Rockwell	17-573	2210-C-5333	Meritor / Rockwell	18-820
2210-A-6319	Meritor / Rockwell	17-583	2210-C-5333S	Meritor / Rockwell	18-820
2210-A-6319S	Meritor / Rockwell	17-583	2210-C-5359	Meritor / Rockwell	18-810
2210-A-6345	Meritor / Rockwell	17-595	2210-C-5619	Meritor / Rockwell	18-810
2210-A-6943	Meritor / Rockwell	18-519	2210-C-5619	Meritor / Rockwell	18-873
2210-A-6995	Meritor / Rockwell	18-529	2210-C-5619S	Meritor / Rockwell	18-957
2210-A-7099	Meritor / Rockwell	18-517	2210-C-5671	Meritor / Rockwell	18-542
2210-A-7125	Meritor / Rockwell	18-501	2210-C-6035	Meritor / Rockwell	18-516
2210-A-7125	Meritor / Rockwell	18-797	2210-C-6035	Meritor / Rockwell	18-798
2210-A-7515	Meritor / Rockwell	18-515	2210-C-6165	Meritor / Rockwell	17-701
2210-A-7645	Meritor / Rockwell	18-537	2210-C-6399S	Meritor / Rockwell	17-586
2210-A-7671	Meritor / Rockwell	18-541	2210-C-6451	Meritor / Rockwell	18-510
2210-B-3226	Meritor / Rockwell	18-806	2210-C-6503	Meritor / Rockwell	18-902
2210-B-4682	Meritor / Rockwell	18-845	2210-C-6503S	Meritor / Rockwell	18-902
2210-B-5020	Meritor / Rockwell	18-858	2210-C-6607	Meritor / Rockwell	18-710
2210-B-5020	Meritor / Rockwell	18-952	2210-C-6607	Meritor / Rockwell	18-930
2210-B-5124	Meritor / Rockwell	18-505	2210-C-6737	Meritor / Rockwell	18-897
2210-B-5124	Meritor / Rockwell	18-825	2210-C-6737S	Meritor / Rockwell	18-897
2210-B-5150	Meritor / Rockwell	17-521	2210-C-6867	Meritor / Rockwell	17-721
2210-B-5332	Meritor / Rockwell	18-519	2210-C-6867S	Meritor / Rockwell	17-721
2210-B-5332	Meritor / Rockwell	18-833	2210-C-7543	Meritor / Rockwell	18-521
2210-B-5332S	Meritor / Rockwell	18-833	2210-C-7569	Meritor / Rockwell	18-525
2210-B-5358	Meritor / Rockwell	18-813	2210-C-7595	Meritor / Rockwell	18-529
2210-B-5410	Meritor / Rockwell	18-846	2210-C-7596	Meritor / Rockwell	18-529
2210-B-5410S	Meritor / Rockwell	18-846	2210-D-1434	Meritor / Rockwell	17-566
2210-B-5722	Meritor / Rockwell	18-801	2210-D-1434	Meritor / Rockwell	17-578
2210-B-5722S	Meritor / Rockwell	18-801	2210-D-3046	Meritor / Rockwell	18-787
2210-B-5748	Meritor / Rockwell	18-844	2210-D-3098	Meritor / Rockwell	18-853
2210-B-5748S	Meritor / Rockwell	18-844	2210-D-5022	Meritor / Rockwell	18-954
2210-B-6008	Meritor / Rockwell	17-572	2210-D-5100	Meritor / Rockwell	18-524
2210-B-6502	Meritor / Rockwell	18-903	2210-D-5100	Meritor / Rockwell	18-868
2210-B-6502S	Meritor / Rockwell	18-903	2210-D-5126	Meritor / Rockwell	18-527
2210-B-6866	Meritor / Rockwell	17-720	2210-D-5126	Meritor / Rockwell	18-837
2210-B-6866S	Meritor / Rockwell	17-720	2210-D-5334	Meritor / Rockwell	18-529
2210-B-7542	Meritor / Rockwell	18-520	2210-D-5334	Meritor / Rockwell	18-821
2210-B-7568	Meritor / Rockwell	18-524	2210-D-5334S	Meritor / Rockwell	18-821

CROSS REFERENCE

Manufacturer Number	Manufacturer	Spicer Number	Manufacturer Number	Manufacturer	Spicer Number
2210-D-5360	Meritor / Rockwell	18-811	2210-E-5439S	Meritor / Rockwell	18-824
2210-D-5620	Meritor / Rockwell	18-811	2210-E-5465	Meritor / Rockwell	18-878
2210-D-5620	Meritor / Rockwell	18-872	2210-E-5543	Meritor / Rockwell	18-854
2210-D-5620S	Meritor / Rockwell	18-956	2210-E-5631S	Meritor / Rockwell	18-826
2210-D-5672	Meritor / Rockwell	18-543	2210-E-5673	Meritor / Rockwell	18-875
2210-D-5932	Meritor / Rockwell	18-538	2210-E-5673	Meritor / Rockwell	18-959
2210-D-6036	Meritor / Rockwell	18-517	2210-E-5725	Meritor / Rockwell	18-852
2210-D-6036	Meritor / Rockwell	18-799	2210-E-5803	Meritor / Rockwell	18-881
2210-D-6166	Meritor / Rockwell	17-700	2210-E-5933	Meritor / Rockwell	18-539
2210-D-6400S	Meritor / Rockwell	17-587	2210-E-6167	Meritor / Rockwell	17-703
2210-D-6452	Meritor / Rockwell	18-511	2210-E-6531	Meritor / Rockwell	18-896
2210-D-6530	Meritor / Rockwell	17-587	2210-E-6531S	Meritor / Rockwell	18-896
2210-D-6530	Meritor / Rockwell	18-897	2210-E-6739	Meritor / Rockwell	18-907
2210-D-6530S	Meritor / Rockwell	18-897	2210-E-6843	Meritor / Rockwell	18-954
2210-D-6608	Meritor / Rockwell	18-711	2210-E-6869	Meritor / Rockwell	17-725
2210-D-6608	Meritor / Rockwell	18-931	2210-E-6869S	Meritor / Rockwell	17-725
2210-D-6738	Meritor / Rockwell	18-896	2210-E-7181	Meritor / Rockwell	18-807
2210-D-6738S	Meritor / Rockwell	18-896	2210-E-7493	Meritor / Rockwell	18-511
2210-D-6842	Meritor / Rockwell	18-955	2210-F-3594	Meritor / Rockwell	17-580
2210-D-6868	Meritor / Rockwell	17-724	2210-F-4478	Meritor / Rockwell	18-855
2210-D-6868S	Meritor / Rockwell	17-724	2210-F-4790	Meritor / Rockwell	18-887
2210-D-7180	Meritor / Rockwell	18-806	2210-F-4920	Meritor / Rockwell	17-611
2210-D-7492	Meritor / Rockwell	18-510	2210-F-5050	Meritor / Rockwell	18-814
2210-E-1435	Meritor / Rockwell	17-567	2210-F-5128	Meritor / Rockwell	18-535
2210-E-1435	Meritor / Rockwell	17-579	2210-F-5128	Meritor / Rockwell	18-835
2210-E-3047	Meritor / Rockwell	18-786	2210-F-5180	Meritor / Rockwell	18-521
2210-E-4477	Meritor / Rockwell	18-854	2210-F-5180	Meritor / Rockwell	18-867
2210-E-4919	Meritor / Rockwell	17-610	2210-F-5258	Meritor / Rockwell	18-874
2210-E-5049	Meritor / Rockwell	18-815	2210-F-5258	Meritor / Rockwell	18-958
2210-E-5101	Meritor / Rockwell	18-525	2210-F-5310	Meritor / Rockwell	18-812
2210-E-5101	Meritor / Rockwell	18-869	2210-F-5362	Meritor / Rockwell	18-511
2210-E-5127	Meritor / Rockwell	18-534	2210-F-5362	Meritor / Rockwell	18-827
2210-E-5127	Meritor / Rockwell	18-834	2210-F-5362S	Meritor / Rockwell	18-827
2210-E-5179	Meritor / Rockwell	18-520	2210-F-5414	Meritor / Rockwell	17-581
2210-E-5179	Meritor / Rockwell	18-866	2210-F-5440	Meritor / Rockwell	18-505
2210-E-5257	Meritor / Rockwell	18-875	2210-F-5440	Meritor / Rockwell	18-825
2210-E-5257	Meritor / Rockwell	18-959	2210-F-5440S	Meritor / Rockwell	18-825
2210-E-5309	Meritor / Rockwell	18-813	2210-F-5466	Meritor / Rockwell	18-879
2210-E-5361	Meritor / Rockwell	18-510	2210-F-5544	Meritor / Rockwell	18-855
2210-E-5361	Meritor / Rockwell	18-826	2210-F-5674	Meritor / Rockwell	18-874
2210-E-5413	Meritor / Rockwell	17-580	2210-F-5674	Meritor / Rockwell	18-958
2210-E-5439	Meritor / Rockwell	18-504	2210-F-5726	Meritor / Rockwell	18-853
2210-E-5439	Meritor / Rockwell	18-824	2210-F-5804	Meritor / Rockwell	18-880

Manufacturer Number	Manufacturer	Spicer Number	Manufacturer Number	Manufacturer	Spicer Number
2210-F-5960	Meritor / Rockwell	17-703	2210-H-5338	Meritor / Rockwell	18-503
2210-F-6168	Meritor / Rockwell	17-702	2210-H-5338	Meritor / Rockwell	18-861
2210-F-6480	Meritor / Rockwell	18-891	2210-H-5390	Meritor / Rockwell	18-817
2210-F-6480S	Meritor / Rockwell	18-891	2210-H-5390S	Meritor / Rockwell	18-817
2210-F-6740	Meritor / Rockwell	18-906	2210-H-5416	Meritor / Rockwell	18-521
2210-F-6844	Meritor / Rockwell	18-857	2210-H-5416	Meritor / Rockwell	18-867
2210-F-6844	Meritor / Rockwell	18-951	2210-H-5442	Meritor / Rockwell	18-531
2210-F-6870	Meritor / Rockwell	17-722	2210-H-5546	Meritor / Rockwell	18-795
2210-F-6870S	Meritor / Rockwell	17-722	2210-H-5728	Meritor / Rockwell	18-882
2210-F-7000	Meritor / Rockwell	18-530	2210-H-6014	Meritor / Rockwell	17-715
2210-F-7442	Meritor / Rockwell	18-506	2210-H-6170	Meritor / Rockwell	17-714
2210-G-2399	Meritor / Rockwell	18-809	2210-H-6482	Meritor / Rockwell	17-715
2210-G-2555	Meritor / Rockwell	17-576	2210-H-6482	Meritor / Rockwell	18-905
2210-G-3595	Meritor / Rockwell	17-581	2210-H-6482S	Meritor / Rockwell	18-905
2210-G-4791	Meritor / Rockwell	18-886	2210-H-6612	Meritor / Rockwell	18-898
2210-G-4869	Meritor / Rockwell	18-832	2210-H-6612S	Meritor / Rockwell	18-898
2210-G-5337	Meritor / Rockwell	18-502	2210-H-6664	Meritor / Rockwell	18-523
2210-G-5337	Meritor / Rockwell	18-860	2210-H-6820	Meritor / Rockwell	18-930
2210-G-5389	Meritor / Rockwell	18-816	2210-H-6976	Meritor / Rockwell	18-936
2210-G-5389S	Meritor / Rockwell	18-816	2210-H-7106	Meritor / Rockwell	18-522
2210-G-5415	Meritor / Rockwell	18-520	2210-H-7522	Meritor / Rockwell	18-516
2210-G-5415	Meritor / Rockwell	18-866	2210-H-7626	Meritor / Rockwell	18-534
2210-G-5441	Meritor / Rockwell	18-530	2210-H-7652	Meritor / Rockwell	18-538
2210-G-5545	Meritor / Rockwell	18-794	2210-J-2558	Meritor / Rockwell	17-578
2210-G-5727	Meritor / Rockwell	18-883	2210-J-2948	Meritor / Rockwell	17-585
2210-G-5961	Meritor / Rockwell	17-702	2210-J-3026	Meritor / Rockwell	18-803
2210-G-6013	Meritor / Rockwell	17-714	2210-J-3104	Meritor / Rockwell	18-724
2210-G-6169	Meritor / Rockwell	17-715	2210-J-6484	Meritor / Rockwell	18-904
2210-G-6481	Meritor / Rockwell	17-714	2210-J-6484S	Meritor / Rockwell	18-904
2210-G-6481	Meritor / Rockwell	18-890	2210-J-6614	Meritor / Rockwell	18-893
2210-G-6481S	Meritor / Rockwell	18-890	2210-J-6614S	Meritor / Rockwell	18-893
2210-G-6611	Meritor / Rockwell	18-899	2210-J-6744	Meritor / Rockwell	18-899
2210-G-6611S	Meritor / Rockwell	18-899	2210-J-6822	Meritor / Rockwell	18-931
2210-G-6663	Meritor / Rockwell	18-522	2210-J-6978	Meritor / Rockwell	18-937
2210-G-6845	Meritor / Rockwell	18-856	2210-J-7108	Meritor / Rockwell	18-523
2210-G-6845	Meritor / Rockwell	18-950	2210-J-7524	Meritor / Rockwell	18-517
2210-G-6871	Meritor / Rockwell	17-723	2210-J-7628	Meritor / Rockwell	18-535
2210-G-6871S	Meritor / Rockwell	17-723	2210-J-7654	Meritor / Rockwell	18-539
2210-G-7001	Meritor / Rockwell	18-531	2210-K-2559	Meritor / Rockwell	17-579
2210-G-7443	Meritor / Rockwell	18-507	2210-K-3027	Meritor / Rockwell	18-808
2210-H-2400	Meritor / Rockwell	18-808	2210-K-3105	Meritor / Rockwell	18-725
2210-H-2946	Meritor / Rockwell	17-584	2210-K-5107	Meritor / Rockwell	18-514
2210-H-3024	Meritor / Rockwell	18-802	2210-K-5107	Meritor / Rockwell	18-828

CROSS REFERENCE

Manufacturer Number	Manufacturer	Spicer Number	Manufacturer Number	Manufacturer	Spicer Number
2210-K-5185	Meritor / Rockwell	18-810	2210-L-5550	Meritor / Rockwell	18-791
2210-K-5263	Meritor / Rockwell	18-807	2210-L-5784	Meritor / Rockwell	18-541
2210-K-5341	Meritor / Rockwell	18-526	2210-L-5784	Meritor / Rockwell	18-713
2210-K-5341	Meritor / Rockwell	18-836	2210-L-6746	Meritor / Rockwell	18-901
2210-K-5341S	Meritor / Rockwell	18-836	2210-L-7006	Meritor / Rockwell	18-543
2210-K-5367	Meritor / Rockwell	18-518	2210-L-7214	Meritor / Rockwell	18-523
2210-K-5393	Meritor / Rockwell	18-542	2210-L-7396	Meritor / Rockwell	18-501
2210-K-5393	Meritor / Rockwell	18-716	2210-L-7500	Meritor / Rockwell	18-513
2210-K-5445	Meritor / Rockwell	18-536	2210-L-7552	Meritor / Rockwell	18-523
2210-K-5445	Meritor / Rockwell	18-780	2210-L-7604	Meritor / Rockwell	18-531
2210-K-5549	Meritor / Rockwell	18-790	2210-L-7838	Meritor / Rockwell	18-533
2210-K-5783	Meritor / Rockwell	18-540	2210-M-1573	Meritor / Rockwell	17-566
2210-K-5783	Meritor / Rockwell	18-712	2210-M-2405	Meritor / Rockwell	18-812
2210-K-6615	Meritor / Rockwell	18-892	2210-M-2483	Meritor / Rockwell	17-580
2210-K-6615S	Meritor / Rockwell	18-892	2210-M-4329	Meritor / Rockwell	17-627
2210-K-6745	Meritor / Rockwell	18-898	2210-M-4329	Meritor / Rockwell	17-721
2210-K-7005	Meritor / Rockwell	18-542	2210-M-4329	Meritor / Rockwell	17-811
2210-K-7213	Meritor / Rockwell	18-522	2210-M-5135	Meritor / Rockwell	18-528
2210-K-7395	Meritor / Rockwell	18-500	2210-M-5135	Meritor / Rockwell	18-820
2210-K-7499	Meritor / Rockwell	18-512	2210-M-5161	Meritor / Rockwell	18-507
2210-K-7551	Meritor / Rockwell	18-522	2210-M-5161	Meritor / Rockwell	18-851
2210-K-7603	Meritor / Rockwell	18-530	2210-M-5343	Meritor / Rockwell	18-536
2210-K-7837	Meritor / Rockwell	18-532	2210-M-5369	Meritor / Rockwell	18-534
2210-L-2404	Meritor / Rockwell	18-813	2210-M-5369	Meritor / Rockwell	18-834
2210-L-3028	Meritor / Rockwell	18-809	2210-M-5395	Meritor / Rockwell	18-532
2210-L-4328	Meritor / Rockwell	17-626	2210-M-5395	Meritor / Rockwell	18-822
2210-L-4328	Meritor / Rockwell	17-720	2210-M-5395S	Meritor / Rockwell	18-822
2210-L-4328	Meritor / Rockwell	17-810	2210-M-5421	Meritor / Rockwell	18-814
2210-L-5108	Meritor / Rockwell	18-515	2210-M-5421S	Meritor / Rockwell	18-814
2210-L-5108	Meritor / Rockwell	18-829	2210-M-5447	Meritor / Rockwell	17-520
2210-L-5160	Meritor / Rockwell	18-506	2210-M-6747	Meritor / Rockwell	18-900
2210-L-5160	Meritor / Rockwell	18-850	2210-M-6851	Meritor / Rockwell	18-953
2210-L-5186	Meritor / Rockwell	18-811	2210-M-7189	Meritor / Rockwell	18-538
2210-L-5264	Meritor / Rockwell	18-806	2210-M-7449	Meritor / Rockwell	18-936
2210-L-5342	Meritor / Rockwell	18-527	2210-N-1574	Meritor / Rockwell	17-567
2210-L-5342	Meritor / Rockwell	18-837	2210-N-2406	Meritor / Rockwell	18-819
2210-L-5342S	Meritor / Rockwell	18-837	2210-N-2484	Meritor / Rockwell	17-581
2210-L-5368	Meritor / Rockwell	18-519	2210-N-2562	Meritor / Rockwell	17-572
2210-L-5394	Meritor / Rockwell	18-543	2210-N-4300	Meritor / Rockwell	17-814
2210-L-5394	Meritor / Rockwell	18-717	2210-N-4330	Meritor / Rockwell	17-630
2210-L-5396	Meritor / Rockwell	18-533	2210-N-4330	Meritor / Rockwell	17-724
2210-L-5446	Meritor / Rockwell	18-537	2210-N-4870	Meritor / Rockwell	18-833
2210-L-5446	Meritor / Rockwell	18-781	2210-N-5136	Meritor / Rockwell	18-529

Manufacturer Number	Manufacturer	Spicer Number	Manufacturer Number	Manufacturer	Spicer Number
2210-N-5136	Meritor / Rockwell	18-821	2210-Q-5009	Meritor / Rockwell	18-813
2210-N-5344	Meritor / Rockwell	18-537	2210-Q-5061	Meritor / Rockwell	18-873
2210-N-5370	Meritor / Rockwell	18-535	2210-Q-5061	Meritor / Rockwell	18-957
2210-N-5370	Meritor / Rockwell	18-835	2210-Q-5087	Meritor / Rockwell	18-831
2210-N-5396	Meritor / Rockwell	18-823	2210-Q-5139	Meritor / Rockwell	18-502
2210-N-5396S	Meritor / Rockwell	18-823	2210-Q-5139	Meritor / Rockwell	18-860
2210-N-5422	Meritor / Rockwell	18-815	2210-Q-5373	Meritor / Rockwell	18-862
2210-N-5422S	Meritor / Rockwell	18-815	2210-Q-5399	Meritor / Rockwell	18-1129
2210-N-5448	Meritor / Rockwell	17-521	2210-Q-5399	Meritor / Rockwell	18-955
2210-N-5838	Meritor / Rockwell	18-500	2210-Q-5503	Meritor / Rockwell	18-714
2210-N-6592	Meritor / Rockwell	17-658	2210-Q-5555	Meritor / Rockwell	18-857
2210-N-6592	Meritor / Rockwell	17-722	2210-Q-5555S	Meritor / Rockwell	18-857
2210-N-6722	Meritor / Rockwell	18-903	2210-Q-5555S	Meritor / Rockwell	18-951
2210-N-6852	Meritor / Rockwell	18-952	2210-Q-5607	Meritor / Rockwell	18-877
2210-N-7190	Meritor / Rockwell	18-539	2210-Q-5607S	Meritor / Rockwell	18-877
2210-N-7450	Meritor / Rockwell	18-937	2210-Q-5711	Meritor / Rockwell	17-572
2210-P-2408	Meritor / Rockwell	18-818	2210-Q-5711S	Meritor / Rockwell	17-572
2210-P-2460	Meritor / Rockwell	18-801	2210-Q-5737	Meritor / Rockwell	18-782
2210-P-2564	Meritor / Rockwell	17-573	2210-Q-6387	Meritor / Rockwell	17-586
2210-P-2798	Meritor / Rockwell	18-840	2210-Q-6517	Meritor / Rockwell	18-901
2210-P-2980	Meritor / Rockwell	18-811	2210-Q-6517S	Meritor / Rockwell	18-901
2210-P-4332	Meritor / Rockwell	17-631	2210-Q-6543	Meritor / Rockwell	18-908
2210-P-4332	Meritor / Rockwell	17-725	2210-Q-6543S	Meritor / Rockwell	18-908
2210-P-4332	Meritor / Rockwell	17-815	2210-Q-6725	Meritor / Rockwell	18-905
2210-P-5086	Meritor / Rockwell	18-830	2210-Q-6751	Meritor / Rockwell	18-909
2210-P-5840	Meritor / Rockwell	18-501	2210-Q-6959	Meritor / Rockwell	18-511
2210-P-6542	Meritor / Rockwell	18-909	2210-Q-6985	Meritor / Rockwell	18-535
2210-P-6542S	Meritor / Rockwell	18-909	2210-Q-7427	Meritor / Rockwell	18-505
2210-P-6594	Meritor / Rockwell	17-659	2210-Q-8155	Meritor / Rockwell	17-810
2210-P-6594	Meritor / Rockwell	17-723	2210-R-2488	Meritor / Rockwell	17-576
2210-P-6724	Meritor / Rockwell	18-902	2210-R-2566	Meritor / Rockwell	17-595
2210-P-6958	Meritor / Rockwell	18-510	2210-R-4178	Meritor / Rockwell	17-640
2210-P-6984	Meritor / Rockwell	18-534	2210-R-4334	Meritor / Rockwell	17-629
2210-P-7426	Meritor / Rockwell	18-504	2210-R-4334	Meritor / Rockwell	17-723
2210-Q-2461	Meritor / Rockwell	18-800	2210-R-4334	Meritor / Rockwell	17-813
2210-Q-2565	Meritor / Rockwell	17-594	2210-R-4906	Meritor / Rockwell	18-990
2210-Q-2799	Meritor / Rockwell	18-841	2210-R-4984	Meritor / Rockwell	18-876
2210-Q-2981	Meritor / Rockwell	18-810	2210-R-5010	Meritor / Rockwell	18-812
2210-Q-4333	Meritor / Rockwell	17-628	2210-R-5062	Meritor / Rockwell	18-872
2210-Q-4333	Meritor / Rockwell	17-722	2210-R-5062	Meritor / Rockwell	18-956
2210-Q-4333	Meritor / Rockwell	17-812	2210-R-5088	Meritor / Rockwell	18-862
2210-Q-4905	Meritor / Rockwell	18-991	2210-R-5114	Meritor / Rockwell	18-522
2210-Q-4983	Meritor / Rockwell	18-877	2210-R-5140	Meritor / Rockwell	18-503

CROSS REFERENCE

Manufacturer Number	Manufacturer	Spicer Number	Manufacturer Number	Manufacturer	Spicer Number
2210-R-5140	Meritor / Rockwell	18-861	2210-S-5973	Meritor / Rockwell	18-857
2210-R-5166	Meritor / Rockwell	18-500	2210-S-5973	Meritor / Rockwell	18-951
2210-R-5166	Meritor / Rockwell	18-796	2210-S-6493	Meritor / Rockwell	18-906
2210-R-5374	Meritor / Rockwell	18-863	2210-S-6493S	Meritor / Rockwell	18-906
2210-R-5400	Meritor / Rockwell	18-1130	2210-S-6571	Meritor / Rockwell	18-895
2210-R-5400	Meritor / Rockwell	18-954	2210-S-6571S	Meritor / Rockwell	18-895
2210-R-5504	Meritor / Rockwell	18-715	2210-S-6675	Meritor / Rockwell	18-542
2210-R-5556	Meritor / Rockwell	18-856	2210-S-6727	Meritor / Rockwell	18-891
2210-R-5556S	Meritor / Rockwell	18-856	2210-S-6857	Meritor / Rockwell	18-956
2210-R-5556S	Meritor / Rockwell	18-950	2210-S-6961	Meritor / Rockwell	18-513
2210-R-5608	Meritor / Rockwell	18-876	2210-S-7455	Meritor / Rockwell	18-939
2210-R-5608S	Meritor / Rockwell	18-876	2210-S-7689	Meritor / Rockwell	18-543
2210-R-5712	Meritor / Rockwell	17-573	2210-S-8157	Meritor / Rockwell	17-812
2210-R-5712S	Meritor / Rockwell	17-573	2210-T-2490	Meritor / Rockwell	17-582
2210-R-5738	Meritor / Rockwell	18-783	2210-T-2568	Meritor / Rockwell	18-817
2210-R-6388	Meritor / Rockwell	17-587	2210-T-3374	Meritor / Rockwell	17-588
2210-R-6492	Meritor / Rockwell	18-907	2210-T-3400	Meritor / Rockwell	18-884
2210-R-6492S	Meritor / Rockwell	18-907	2210-T-4180	Meritor / Rockwell	17-642
2210-R-6518	Meritor / Rockwell	18-900	2210-T-4466	Meritor / Rockwell	17-642
2210-R-6518S	Meritor / Rockwell	18-900	2210-T-4466	Meritor / Rockwell	18-791
2210-R-6726	Meritor / Rockwell	18-904	2210-T-4908	Meritor / Rockwell	18-986
2210-R-6752	Meritor / Rockwell	18-908	2210-T-5090	Meritor / Rockwell	18-528
2210-R-6856	Meritor / Rockwell	18-957	2210-T-5090	Meritor / Rockwell	18-820
2210-R-6960	Meritor / Rockwell	18-512	2210-T-5148	Meritor / Rockwell	18-537
2210-R-7454	Meritor / Rockwell	18-938	2210-T-5148	Meritor / Rockwell	18-781
2210-R-7688	Meritor / Rockwell	18-542	2210-T-5246	Meritor / Rockwell	17-701
2210-R-8156	Meritor / Rockwell	17-811	2210-T-5324	Meritor / Rockwell	18-517
2210-S-2489	Meritor / Rockwell	17-577	2210-T-5324	Meritor / Rockwell	18-799
2210-S-2567	Meritor / Rockwell	18-816	2210-T-5376	Meritor / Rockwell	18-807
2210-S-3399	Meritor / Rockwell	18-885	2210-T-5428	Meritor / Rockwell	18-509
2210-S-4179	Meritor / Rockwell	17-641	2210-T-5428	Meritor / Rockwell	18-865
2210-S-4465	Meritor / Rockwell	18-790	2210-T-5506	Meritor / Rockwell	18-513
2210-S-4907	Meritor / Rockwell	18-987	2210-T-5974	Meritor / Rockwell	18-856
2210-S-5089	Meritor / Rockwell	18-863	2210-T-5974	Meritor / Rockwell	18-950
2210-S-5115	Meritor / Rockwell	18-523	2210-T-6572	Meritor / Rockwell	18-894
2210-S-5167	Meritor / Rockwell	18-501	2210-T-6572S	Meritor / Rockwell	18-894
2210-S-5167	Meritor / Rockwell	18-797	2210-T-6676	Meritor / Rockwell	18-543
2210-S-5323	Meritor / Rockwell	18-516	2210-T-6728	Meritor / Rockwell	18-890
2210-S-5323	Meritor / Rockwell	18-798	2210-T-6733	Meritor / Rockwell	18-895
2210-S-5375	Meritor / Rockwell	18-806	2210-T-6962	Meritor / Rockwell	18-532
2210-S-5427	Meritor / Rockwell	18-508	2210-T-7118	Meritor / Rockwell	18-810
2210-S-5427	Meritor / Rockwell	18-864	2210-T-7456	Meritor / Rockwell	18-508
2210-S-5505	Meritor / Rockwell	18-512	2210-T-7482	Meritor / Rockwell	18-930

Manufacturer Number	Manufacturer	Spicer Number	Manufacturer Number	Manufacturer	Spicer Number
2210-T-7482	Meritor / Rockwell	18-931	2210-V-4910	Meritor / Rockwell	18-792
2210-T-7586	Meritor / Rockwell	18-526	2210-V-5092	Meritor / Rockwell	18-510
2210-T-8158	Meritor / Rockwell	17-813	2210-V-5092	Meritor / Rockwell	18-826
2210-U-2491	Meritor / Rockwell	17-583	2210-V-5144	Meritor / Rockwell	18-543
2210-U-3375	Meritor / Rockwell	17-589	2210-V-5222	Meritor / Rockwell	18-808
2210-U-3401	Meritor / Rockwell	18-883	2210-V-5326	Meritor / Rockwell	18-517
2210-U-4181	Meritor / Rockwell	17-643	2210-V-5326	Meritor / Rockwell	18-831
2210-U-4779	Meritor / Rockwell	18-811	2210-V-5326S	Meritor / Rockwell	18-831
2210-U-4909	Meritor / Rockwell	18-793	2210-V-5378	Meritor / Rockwell	18-811
2210-U-5091	Meritor / Rockwell	18-529	2210-V-5456	Meritor / Rockwell	18-507
2210-U-5091	Meritor / Rockwell	18-821	2210-V-5456	Meritor / Rockwell	18-851
2210-U-5143	Meritor / Rockwell	18-542	2210-V-5534	Meritor / Rockwell	17-579
2210-U-5247	Meritor / Rockwell	17-700	2210-V-5534S	Meritor / Rockwell	17-579
2210-U-5325	Meritor / Rockwell	18-516	2210-V-5612	Meritor / Rockwell	18-858
2210-U-5325	Meritor / Rockwell	18-830	2210-V-5612	Meritor / Rockwell	18-952
2210-U-5325S	Meritor / Rockwell	18-830	2210-V-5638	Meritor / Rockwell	18-819
2210-U-5377	Meritor / Rockwell	18-810	2210-V-5638	Meritor / Rockwell	18-858
2210-U-5455	Meritor / Rockwell	18-506	2210-V-5638S	Meritor / Rockwell	18-819
2210-U-5455	Meritor / Rockwell	18-850	2210-V-6470	Meritor / Rockwell	17-657
2210-U-5533	Meritor / Rockwell	17-578	2210-V-6470	Meritor / Rockwell	17-721
2210-U-5533S	Meritor / Rockwell	17-578	2210-V-6522	Meritor / Rockwell	18-930
2210-U-5611	Meritor / Rockwell	18-859	2210-V-6574	Meritor / Rockwell	17-657
2210-U-5611	Meritor / Rockwell	18-953	2210-V-6574	Meritor / Rockwell	17-721
2210-U-5637	Meritor / Rockwell	18-818	2210-V-6860	Meritor / Rockwell	18-959
2210-U-5637	Meritor / Rockwell	18-859	2210-V-7484	Meritor / Rockwell	18-930
2210-U-5637S	Meritor / Rockwell	18-818	2210-V-7536	Meritor / Rockwell	18-518
2210-U-6469	Meritor / Rockwell	17-656	2210-V-7718	Meritor / Rockwell	17-520
2210-U-6469	Meritor / Rockwell	17-720	2210-V-8160	Meritor / Rockwell	17-815
2210-U-6573	Meritor / Rockwell	17-656	2210-W-2337	Meritor / Rockwell	17-566
2210-U-6573	Meritor / Rockwell	17-720	2210-W-2805	Meritor / Rockwell	18-843
2210-U-6963	Meritor / Rockwell	18-533	2210-W-3117	Meritor / Rockwell	17-574
2210-U-7119	Meritor / Rockwell	18-811	2210-W-3117	Meritor / Rockwell	17-586
2210-U-7457	Meritor / Rockwell	18-509	2210-W-3403	Meritor / Rockwell	18-881
2210-U-7483	Meritor / Rockwell	18-930	2210-W-4183	Meritor / Rockwell	17-633
2210-U-7483	Meritor / Rockwell	18-931	2210-W-5093	Meritor / Rockwell	18-511
2210-U-7485	Meritor / Rockwell	18-931	2210-W-5093	Meritor / Rockwell	18-827
2210-U-7587	Meritor / Rockwell	18-527	2210-W-5145	Meritor / Rockwell	18-530
2210-U-8159	Meritor / Rockwell	17-814	2210-W-5327	Meritor / Rockwell	18-524
2210-V-2804	Meritor / Rockwell	18-842	2210-W-5327	Meritor / Rockwell	18-868
2210-V-3402	Meritor / Rockwell	18-882	2210-W-5353	Meritor / Rockwell	18-808
2210-V-3740	Meritor / Rockwell	18-782	2210-W-5353S	Meritor / Rockwell	18-808
2210-V-4182	Meritor / Rockwell	17-632	2210-W-5379	Meritor / Rockwell	18-724
2210-V-4780	Meritor / Rockwell	18-810	2210-W-5405	Meritor / Rockwell	18-843

CROSS REFERENCE

Manufacturer Number	Manufacturer	Spicer Number	Manufacturer Number	Manufacturer	Spicer Number
2210-W-5405S	Meritor / Rockwell	18-843	2210-X-5718	Meritor / Rockwell	18-803
2210-W-5457	Meritor / Rockwell	18-500	2210-X-5952	Meritor / Rockwell	18-859
2210-W-5457	Meritor / Rockwell	18-796	2210-X-5952	Meritor / Rockwell	18-953
2210-W-5535S	Meritor / Rockwell	18-989	2210-X-6472	Meritor / Rockwell	17-661
2210-W-5639	Meritor / Rockwell	18-804	2210-X-6472	Meritor / Rockwell	17-725
2210-W-5639S	Meritor / Rockwell	18-804	2210-X-6576	Meritor / Rockwell	17-661
2210-W-5665	Meritor / Rockwell	18-885	2210-X-6576	Meritor / Rockwell	17-725
2210-W-5717	Meritor / Rockwell	18-802	2210-X-6732	Meritor / Rockwell	18-892
2210-W-6471	Meritor / Rockwell	17-660	2210-X-6862	Meritor / Rockwell	18-877
2210-W-6471	Meritor / Rockwell	17-724	2210-X-6862	Meritor / Rockwell	18-949
2210-W-6523	Meritor / Rockwell	18-931	2210-X-7070	Meritor / Rockwell	18-540
2210-W-6575	Meritor / Rockwell	17-660	2210-X-7226	Meritor / Rockwell	18-516
2210-W-6575	Meritor / Rockwell	17-724	2210-X-7408	Meritor / Rockwell	18-502
2210-W-6731	Meritor / Rockwell	18-893	2210-Y-2443	Meritor / Rockwell	18-805
2210-W-6861	Meritor / Rockwell	18-958	2210-Y-2911	Meritor / Rockwell	18-841
2210-W-7537	Meritor / Rockwell	18-519	2210-Y-3067	Meritor / Rockwell	18-800
2210-W-7719	Meritor / Rockwell	17-521	2210-Y-3739	Meritor / Rockwell	18-783
2210-X-2338	Meritor / Rockwell	17-567	2210-Y-4991	Meritor / Rockwell	18-857
2210-X-2442	Meritor / Rockwell	18-804	2210-Y-4991	Meritor / Rockwell	18-951
2210-X-2910	Meritor / Rockwell	18-840	2210-Y-5095	Meritor / Rockwell	18-509
2210-X-3066	Meritor / Rockwell	18-801	2210-Y-5095	Meritor / Rockwell	18-865
2210-X-3118	Meritor / Rockwell	17-575	2210-Y-5173	Meritor / Rockwell	18-516
2210-X-3118	Meritor / Rockwell	17-587	2210-Y-5173	Meritor / Rockwell	18-830
2210-X-3404	Meritor / Rockwell	18-880	2210-Y-5329	Meritor / Rockwell	18-522
2210-X-5094	Meritor / Rockwell	18-508	2210-Y-5355	Meritor / Rockwell	18-808
2210-X-5094	Meritor / Rockwell	18-864	2210-Y-5381	Meritor / Rockwell	18-806
2210-X-5146	Meritor / Rockwell	18-531	2210-Y-5381S	Meritor / Rockwell	18-806
2210-X-5147	Meritor / Rockwell	18-536	2210-Y-5407	Meritor / Rockwell	18-841
2210-X-5147	Meritor / Rockwell	18-780	2210-Y-5407S	Meritor / Rockwell	18-841
2210-X-5221	Meritor / Rockwell	18-809	2210-Y-5433	Meritor / Rockwell	18-514
2210-X-5328	Meritor / Rockwell	18-525	2210-Y-5433	Meritor / Rockwell	18-828
2210-X-5328	Meritor / Rockwell	18-869	2210-Y-5459	Meritor / Rockwell	18-888
2210-X-5354	Meritor / Rockwell	18-809	2210-Y-5667	Meritor / Rockwell	18-849
2210-X-5354S	Meritor / Rockwell	18-809	2210-Y-5719	Meritor / Rockwell	18-786
2210-X-5380	Meritor / Rockwell	18-725	2210-Y-5953	Meritor / Rockwell	18-858
2210-X-5406	Meritor / Rockwell	18-842	2210-Y-5953	Meritor / Rockwell	18-952
2210-X-5406S	Meritor / Rockwell	18-842	2210-Y-6473	Meritor / Rockwell	17-658
2210-X-5458	Meritor / Rockwell	18-501	2210-Y-6473	Meritor / Rockwell	17-722
2210-X-5458	Meritor / Rockwell	18-797	2210-Y-6863	Meritor / Rockwell	18-876
2210-X-5536S	Meritor / Rockwell	18-988	2210-Y-6863	Meritor / Rockwell	18-948
2210-X-5640	Meritor / Rockwell	18-805	2210-Y-7071	Meritor / Rockwell	18-541
2210-X-5640S	Meritor / Rockwell	18-805	2210-Y-7227	Meritor / Rockwell	18-517
2210-X-5666	Meritor / Rockwell	18-884	2210-Y-7409	Meritor / Rockwell	18-503

Manufacturer Number	Manufacturer	Spicer Number	Manufacturer Number	Manufacturer	Spicer Number
2210-Z-3330	Meritor / Rockwell	18-523	262163C1	Navistar	18-819
2210-Z-4264	Meritor / Rockwell	18-794	2710-C-211	Meritor / Rockwell	18-807
2210-Z-4836	Meritor / Rockwell	18-849	2710-D-212	Meritor / Rockwell	18-806
2210-Z-4992	Meritor / Rockwell	18-856	295999	Eaton	43-7037A
2210-Z-4992	Meritor / Rockwell	18-950	298921	Eaton	43-7040
2210-Z-5096	Meritor / Rockwell	18-532	305680	Fruehauf	17-577
2210-Z-5096	Meritor / Rockwell	18-822	305680	Fruehauf	17-583
2210-Z-5174	Meritor / Rockwell	18-517	305681	Fruehauf	17-576
2210-Z-5174	Meritor / Rockwell	18-831	305681	Fruehauf	17-582
2210-Z-5356	Meritor / Rockwell	18-809	3109845	White	18-741
2210-Z-5382	Meritor / Rockwell	18-807	3109848	White	18-740
2210-Z-5382S	Meritor / Rockwell	18-807	31944	Wagner	18-540
2210-Z-5408	Meritor / Rockwell	18-840	31945	Wagner	18-541
2210-Z-5408S	Meritor / Rockwell	18-840	3244275R1	Navistar	18-812
2210-Z-5434	Meritor / Rockwell	18-515	35430	Eaton	18-745
2210-Z-5434	Meritor / Rockwell	18-829	35431	Eaton	18-744
2210-Z-5460	Meritor / Rockwell	18-889	35455	Eaton	18-743
2210-Z-5668	Meritor / Rockwell	18-848	35456	Eaton	18-742
2210-Z-5720	Meritor / Rockwell	18-787	363SM72	Mack	18-842
2210-Z-6318	Meritor / Rockwell	17-582	363SM73	Mack	18-843
2210-Z-6318S	Meritor / Rockwell	17-582	363SM80	Mack	17-576
2210-Z-6344	Meritor / Rockwell	17-594	363SM81	Mack	17-577
2210-Z-6474	Meritor / Rockwell	17-659	363SM82	Mack	18-729
2210-Z-6474	Meritor / Rockwell	17-723	363SM83	Mack	18-728
2210-Z-6734	Meritor / Rockwell	18-894	363SM86	Mack	18-738
2210-Z-6942	Meritor / Rockwell	18-518	363SM87	Mack	18-739
2210-Z-6994	Meritor / Rockwell	18-528	38380	Eaton	18-730
2210-Z-7098	Meritor / Rockwell	18-516	385957C1	Navistar	18-738
2210-Z-7124	Meritor / Rockwell	18-500	385957C1	Navistar	18-739
2210-Z-7124	Meritor / Rockwell	18-796	385958C1	Navistar	18-738
2210-Z-7514	Meritor / Rockwell	18-514	39379	Eaton	18-731
2210-Z-7644	Meritor / Rockwell	18-536	40458	Eaton	18-732
2210-Z-7670	Meritor / Rockwell	18-540	40547	Eaton	18-733
2259397	Bendix	18-708	40686	Eaton	18-729
2259398	Bendix	18-709	40687	Eaton	18-728
2259443	Bendix	18-705	41002	Midland	18-805
2259444	Bendix	18-704	41003	Midland	18-804
2291517	GM	18-842	41010	Midland	17-561
2291518	GM	18-843	41010	Midland	18-785
2310N2484	Navistar	17-581	41011	Midland	17-560
259726C1	Navistar	18-812	41011	Midland	18-784
259727C1	Navistar	18-813	41014	Midland	18-809
262162C1	Navistar	18-818	41015	Midland	18-808

CROSS REFERENCE

Manufacturer Number	Manufacturer	Spicer Number	Manufacturer Number	Manufacturer	Spicer Number
41016	Midland	18-811	41414	Midland	17-583
41017	Midland	18-810	41504	Midland	17-627
41022	Midland	18-801	41504	Midland	17-721
41023	Midland	18-800	41504	Midland	17-811
41024	Midland	18-803	41505	Midland	17-626
41025	Midland	18-802	41505	Midland	17-720
41026	Midland	18-727	41505	Midland	17-810
41027	Midland	18-726	41510	Midland	17-701
41028	Midland	18-805	41511	Midland	17-700
41029	Midland	18-804	41512	Midland	17-623
41032	Midland	18-734	41513	Midland	17-622
41033	Midland	18-735	41514	Midland	17-583
41034	Midland	18-807	41515	Midland	17-582
41035	Midland	18-806	41519	Midland	17-598
41036	Midland	18-786	41522	Midland	17-575
41037	Midland	18-787	41523	Midland	17-574
41040	Midland	18-849	41524	Midland	17-587
41041	Midland	18-848	41525	Midland	17-586
41042	Midland	18-741	41526	Midland	17-629
41043	Midland	18-740	41526	Midland	17-723
41044	Midland	18-813	41526	Midland	17-813
41045	Midland	18-812	41527	Midland	17-628
41046	Midland	18-748	41527	Midland	17-722
41047	Midland	18-749	41527	Midland	17-812
41048	Midland	18-742	41528	Midland	17-621
41049	Midland	18-743	41529	Midland	17-620
41050	Midland	18-746	41532	Midland	17-633
41051	Midland	18-747	41533	Midland	17-632
41260	Midland	18-819	41542	Midland	17-594
41261	Midland	18-818	41543	Midland	17-595
41264	Midland	17-577	41544	Midland	17-637
41265	Midland	17-576	41545	Midland	17-636
41266	Midland	17-569	41550	Midland	18-825
41267	Midland	17-568	41551	Midland	18-824
41268	Midland	17-571	41554	Midland	18-865
41269	Midland	17-570	41555	Midland	18-864
41276	Midland	17-641	41556	Midland	18-827
41277	Midland	17-640	41557	Midland	18-826
41278	Midland	17-573	41558	Midland	18-829
41279	Midland	17-572	41559	Midland	18-828
41284	Midland	17-578	41560	Midland	18-831
41292	Midland	17-635	41561	Midland	18-830
41293	Midland	17-634	41562	Midland	18-833

CROSS REFERENCE

Manufacturer Number	Manufacturer	Spicer Number	Manufacturer Number	Manufacturer	Spicer Number
41563	Midland	18-832	41761	Midland	18-738
41564	Midland	18-869	41762	Midland	17-685
41565	Midland	18-868	41763	Midland	17-684
41566	Midland	18-836	41766	Midland	18-763
41567	Midland	18-837	41767	Midland	18-762
41568	Midland	18-821	41768	Midland	18-771
41569	Midland	18-820	41769	Midland	18-770
41572	Midland	18-775	41770	Midland	18-773
41573	Midland	18-774	41771	Midland	18-772
41662	Midland	18-833	41772	Midland	18-775
41663	Midland	18-832	41773	Midland	18-774
41710	Midland	17-683	41780	Midland	18-856
41711	Midland	17-682	41781	Midland	18-857
41712	Midland	17-692	41818	Midland	17-599
41713	Midland	17-693	42SM34	Mack	18-841
41714	Midland	17-699	42SM35	Mack	18-840
41715	Midland	17-698	42SM36	Mack	18-811
41718	Midland	17-691	42SM37	Mack	18-810
41719	Midland	17-690	42SM40	Mack	18-800
41722	Midland	17-695	42SM41	Mack	18-801
41723	Midland	17-694	42SM45	Mack	18-803
41724	Midland	17-649	42SM46	Mack	18-802
41725	Midland	17-648	42SM51	Mack	18-731
41726	Midland	17-697	42SM52	Mack	18-730
41727	Midland	17-696	42SM56	Mack	18-806
41730	Midland	17-623	42SM57	Mack	18-807
41731	Midland	17-622	431566C1	Navistar	18-741
41732	Midland	17-618	431567C1	Navistar	18-740
41750	Midland	18-773	45530	Eaton	18-737
41751	Midland	18-772	45531	Eaton	18-736
41752	Midland	17-643	46-1-125	Fruehauf	43-7037
41753	Midland	17-642	46-1-150	Fruehauf	17-580
41754	Midland	17-589	46-1-151	Fruehauf	17-581
41755	Midland	17-588	46-1-152	Fruehauf	17-594
41756	Midland	17-597	46-1-153	Fruehauf	17-595
41757	Midland	17-596	46-1-154	Fruehauf	17-588
41758	Midland	17-631	46-1-155	Fruehauf	17-589
41758	Midland	17-725	46-1-156	Fruehauf	17-574
41758	Midland	17-815	46-1-157	Fruehauf	17-575
41759	Midland	17-630	46-1-160	Fruehauf	17-582
41759	Midland	17-724	46-1-161	Fruehauf	17-583
41759	Midland	17-814	46-1-164	Fruehauf	17-576
41760	Midland	18-739	46-1-165	Fruehauf	17-577

CROSS REFERENCE

Manufacturer Number	Manufacturer	Spicer Number	Manufacturer Number	Manufacturer	Spicer Number
46-1-170	Fruehauf	17-630	588987C91	Navistar	18-831
46-1-171	Fruehauf	17-631	588988C91	Navistar	18-830
46-1-174	Fruehauf	17-626	588994C91	Navistar	18-868
46-1-175	Fruehauf	17-627	588995C91	Navistar	18-869
46-1-176	Fruehauf	17-628	588998C91	Navistar	18-820
46-1-177	Fruehauf	17-629	588999C91	Navistar	18-821
46-1-178	Fruehauf	17-632	590041C91	Navistar	18-813
46-1-179	Fruehauf	17-633	590047C1	Navistar	18-878
46-1-180	Fruehauf	17-586	590048C1	Navistar	18-879
46-1-181	Fruehauf	17-587	590163C91	Navistar	18-841
462421C1	Navistar	18-735	590164C91	Navistar	18-840
462422C1	Navistar	18-734	590165C91	Navistar	18-843
46-3-032	Fruehauf	17-634	590166C91	Navistar	18-842
46-3-033	Fruehauf	17-635	590196C1	Navistar	18-815
46-3-034	Fruehauf	17-636	590566C91	Navistar	18-823
46-3-035	Fruehauf	17-637	590567C91	Navistar	18-822
46-3-050	Fruehauf	17-638	590587C91	Navistar	18-857
46-3-051	Fruehauf	17-639	590588C91	Navistar	18-856
46-4-029	Fruehauf	17-684	590665C2	Navistar	18-874
46-4-030	Fruehauf	17-685	590666C2	Navistar	18-875
46-4-031	Fruehauf	17-690	591197C1	Navistar	18-814
46-4-032	Fruehauf	17-691	594302C1	Navistar	18-829
46-4-033	Fruehauf	17-692	594303C1	Navistar	18-828
46-4-034	Fruehauf	17-693	596362C1	Navistar	17-520
46-5-030	Fruehauf	17-620	596363C1	Navistar	17-521
46-5-031	Fruehauf	17-621	648278	White	18-842
46-5-032	Fruehauf	17-622	648279	White	18-843
46-5-033	Fruehauf	17-623	654699	Eaton	18-745
46-5-060	Fruehauf	17-616	655064	Eaton	18-744
46-5-061	Fruehauf	17-617	655429	Eaton	18-743
501788C1	Navistar	18-747	655794	Eaton	18-742
501789C1	Navistar	18-746	656160	Eaton	18-734
506673C1	Navistar	18-749	656525	Eaton	18-735
506674C1	Navistar	18-748	656890	Eaton	18-737
56110R1	Navistar	17-576	657255	Eaton	18-736
56110R21	Navistar	17-576	657620	Eaton	18-749
56111R1	Navistar	17-577	657985	Eaton	18-748
56111R21	Navistar	17-577	658350	Eaton	18-763
580443	Fruehauf	17-581	658715	Eaton	18-762
580444	Fruehauf	17-580	659081	Eaton	18-773
585958C1	Navistar	18-739	659446	Eaton	18-772
586792C1	Navistar	18-837	659811	Eaton	18-771
586793C1	Navistar	18-836	660176	Eaton	18-770

Manufacturer Number	Manufacturer	Spicer Number	Manufacturer Number	Manufacturer	Spicer Number
660542	Eaton	18-775	7-3696	Eaton Top Spec	18-734
660907	Eaton	18-774	7-3697	Eaton Top Spec	18-735
66740	Midland	43-7038	7-3698	Eaton Top Spec	18-737
67208	Midland	43-7046A	7-3699	Eaton Top Spec	18-736
67324	Midland	43-7039	7-3700	Eaton Top Spec	18-749
67325	Midland	43-7042	7-3701	Eaton Top Spec	18-748
67326	Midland	43-7041	7-3702	Eaton Top Spec	18-763
67327	Midland	43-7034	7-3703	Eaton Top Spec	18-762
67328	Midland	43-7044	7-3704	Eaton Top Spec	18-773
67331	Midland	43-7029	7-3705	Eaton Top Spec	18-772
67332	Midland	43-7032	7-3706	Eaton Top Spec	18-771
67334	Midland	43-7037	7-3707	Eaton Top Spec	18-770
70306	Eaton	18-739	7-3708	Eaton Top Spec	18-775
70307	Eaton	18-738	7-3709	Eaton Top Spec	18-774
70308	Eaton	18-735	7-5-64L	Trailmobile	17-581
70309	Eaton	18-734	7-5-64R	Trailmobile	17-580
71306	Eaton	18-741	806526	Eaton	18-943
71307	Eaton	18-740	806527	Eaton	18-942
714929	White	18-841	806654	Eaton	17-463
714930	White	18-840	806655	Eaton	17-462
72397	Eaton	18-852	807140	Eaton	18-755
72398	Eaton	18-853	807141	Eaton	18-754
76293	Eaton	18-737	807286	Eaton	17-635
76294	Eaton	18-736	807287	Eaton	17-634
78500	Midland	43-7069	807304	Eaton	17-637
7-2389	Eaton Top Spec	18-727	807305	Eaton	17-636
7-2390	Eaton Top Spec	18-726	807858	Eaton	18-983
7-2395	Eaton Top Spec	18-738	807859	Eaton	18-982
7-2396	Eaton Top Spec	18-739	807862	Eaton	18-945
7-2399	Eaton Top Spec	18-740	807863	Eaton	18-944
7-2400	Eaton Top Spec	18-741	808064	Eaton	18-997
7-2403	Eaton Top Spec	17-578	808065	Eaton	18-996
7-2404	Eaton Top Spec	17-579	808068	Eaton	18-995
7-2407	Eaton Top Spec	17-635	808069	Eaton	18-994
7-2408	Eaton Top Spec	17-634	808078	Eaton	17-461
7-2409	Eaton Top Spec	17-682	808079	Eaton	17-460
7-2410	Eaton Top Spec	17-683	808290	Eaton	18-985
7-2421	Eaton Top Spec	17-698	808291	Eaton	18-984
7-2422	Eaton Top Spec	17-699	808296	Eaton	18-947
7-3692	Eaton Top Spec	18-745	808297	Eaton	18-946
7-3693	Eaton Top Spec	18-744	808708	Eaton	18-941
7-3694	Eaton Top Spec	18-743	808709	Eaton	18-940
7-3695	Eaton Top Spec	18-742	808792	Eaton	18-731

CROSS REFERENCE

Manufacturer Number	Manufacturer	Spicer Number	Manufacturer Number	Manufacturer	Spicer Number
808793	Eaton	18-730	820243	Eaton	17-699
810025	Eaton	17-473	820244	Eaton	17-698
810026	Eaton	17-472	820249	Eaton	17-682
810538	Eaton	17-471	820250	Eaton	17-683
810539	Eaton	17-470	822157	Eaton	17-699
811406	Eaton	18-1127	822158	Eaton	17-698
811407	Eaton	18-1128	822340	Eaton	17-588
813478	Eaton	18-965	822341	Eaton	17-589
813479	Eaton	18-964	838550	White	18-812
813480	Eaton	18-973	838551	White	18-813
813481	Eaton	18-972	843368	White	18-810
813482	Eaton	18-975	843369	White	18-811
813483	Eaton	18-974	848277	White	18-843
813484	Eaton	18-979	848278	White	18-842
813485	Eaton	18-978	850959	White	18-819
813486	Eaton	18-963	853111	White	18-803
813487	Eaton	18-962	853112	White	18-802
813488	Eaton	18-969	861563	White	18-728
813489	Eaton	18-968	861564	White	18-729
813490	Eaton	18-967	862665	White	18-731
813491	Eaton	18-966	862668	White	18-730
813492	Eaton	18-961	870972	White	18-846
813493	Eaton	18-960	870973	White	18-847
813494	Eaton	18-977	871484	White	18-800
813495	Eaton	18-976	874372	White	18-809
813496	Eaton	18-971	874373	White	18-808
813497	Eaton	18-970	874410	White	18-732
813498	Eaton	18-981	874411	White	18-733
813499	Eaton	18-980	890955	White	18-818
819226	White	18-743	89117	Eaton	18-729
819227	White	18-742	89118	Eaton	18-728
820073	Eaton	17-11071	89163	Eaton	18-753
820074	Eaton	17-11072	89164	Eaton	18-752
820078	Eaton	17-574	966152R1	Navistar	18-806
820080	Eaton	17-575	966153R1	Navistar	18-807
820083	Eaton	17-586	ACD-2193-1	Fruehauf	17-625
820084	Eaton	17-587	ACD-2193-2	Fruehauf	17-624
820087	Eaton	17-597	ACD-2193-5	Fruehauf	17-618
820088	Eaton	17-596	ACD-2193-6	Fruehauf	17-619
820102	Eaton	18-785	APA-0998-1	Fruehauf	17-615
820108	Eaton	18-784	APA-0998-2	Fruehauf	17-614
820239	Eaton	17-698	APA-9980-1	Fruehauf	17-615
820240	Eaton	17-699	APA-9980-2	Fruehauf	17-614

Manufacturer Number	Manufacturer	Spicer Number	Manufacturer Number	Manufacturer	Spicer Number
AXA-0420-1	Fruehauf	17-621	B-1054R	Brunner	18-806
AXA-0420-2	Fruehauf	17-620	B-1056L	Brunner	18-809
AXA-0420-3	Fruehauf	17-623	B-1056R	Brunner	18-808
AXA-0420-4	Fruehauf	17-622	B-1057L	Brunner	18-787
AXA-0420-5	Fruehauf	17-616	B-1057R	Brunner	18-786
AXA-0420-6	Fruehauf	17-617	B-1060L	Brunner	18-853
B-1000L	Brunner	18-727	B-1060R	Brunner	18-852
B-1000R	Brunner	18-726	B-1062L	Brunner	18-813
B-1002L	Brunner	18-729	B-1062R	Brunner	18-812
B-1002R	Brunner	18-728	B-1064L	Brunner	18-819
B-1003L	Brunner	18-735	B-1064R	Brunner	18-818
B-1003R	Brunner	18-734	B-1065L	Brunner	17-571
B-1004L	Brunner	18-731	B-1065R	Brunner	17-570
B-1004R	Brunner	18-730	B-1067L	Brunner	18-815
B-1005L	Brunner	18-737	B-1067R	Brunner	18-814
B-1005R	Brunner	18-736	B-1072L	Brunner	18-817
B-1006L	Brunner	18-739	B-1072R	Brunner	18-816
B-1006R	Brunner	18-738	B-1074L	Brunner	18-791
B-1008L	Brunner	18-741	B-1074R	Brunner	18-790
B-1008R	Brunner	18-740	B-1100L	Brunner	17-569
B-1009L	Brunner	18-749	B-1100R	Brunner	17-568
B-1009R	Brunner	18-748	B-1106L	Brunner	18-739
B-1010L	Brunner	18-743	B-1109L	Brunner	17-11071
B-1010R	Brunner	18-742	B-1109R	Brunner	17-11072
B-1011L	Brunner	18-747	B-1116L	Brunner	17-575
B-1011R	Brunner	18-746	B-1116R	Brunner	17-574
B-1012L	Brunner	18-745	B-1118L	Brunner	17-587
B-1012R	Brunner	18-744	B-1118R	Brunner	17-586
B-1014L	Brunner	18-751	B-1120L	Brunner	17-589
B-1014R	Brunner	18-750	B-1120R	Brunner	17-588
B-1018L	Brunner	18-753	B-1122L	Brunner	17-597
B-1018R	Brunner	18-752	B-1122R	Brunner	17-596
B-1045L	Brunner	18-783	B-1147L	Brunner	17-689
B-1045R	Brunner	18-782	B-1147R	Brunner	17-688
B-1046L	Brunner	18-801	B-1148L	Brunner	17-681
B-1046R	Brunner	18-800	B-1148R	Brunner	17-680
B-1048L	Brunner	18-803	B-1149L	Brunner	17-679
B-1048R	Brunner	18-802	B-1149R	Brunner	17-678
B-1050L	Brunner	18-805	B-1152L	Brunner	17-683
B-1050R	Brunner	18-804	B-1152R	Brunner	17-682
B-1052L	Brunner	18-785	B-1153L	Brunner	17-677
B-1052R	Brunner	18-784	B-1153R	Brunner	17-676
B-1054L	Brunner	18-807	B-1154L	Brunner	17-685

CROSS REFERENCE

Manufacturer Number	Manufacturer	Spicer Number	Manufacturer Number	Manufacturer	Spicer Number
B-1154R	Brunner	17-684	B-1691-55	Eaton	17-587
B-1155L	Brunner	17-687	B-1691-56	Eaton	17-586
B-1155R	Brunner	17-686	B-1691-59	Eaton	17-597
B-1156L	Brunner	17-699	B-1691-6	Eaton	17-566
B-1156R	Brunner	17-698	B-1691-60	Eaton	17-596
B-1157L	Brunner	17-693	B-1691-9	Eaton	17-599
B-1157R	Brunner	17-692	B-1735-1	Eaton	18-785
B-1158L	Brunner	17-691	B-1735-2	Eaton	18-784
B-1158R	Brunner	17-690	B-2001L	Brunner	17-639
B-1160L	Brunner	17-695	B-2001R	Brunner	17-638
B-1160R	Brunner	17-694	B-2005L	Brunner	17-657
B-1164L	Brunner	17-707	B-2005R	Brunner	17-656
B-1164R	Brunner	17-706	B-2007L	Brunner	17-659
B-1166L	Brunner	17-697	B-2007R	Brunner	17-658
B-1166R	Brunner	17-696	B-2009L	Brunner	17-661
B-1181L	Brunner	17-635	B-2009R	Brunner	17-660
B-1181R	Brunner	17-634	B-2050L	Brunner	17-621
B-1183L	Brunner	17-637	B-2050R	Brunner	17-620
B-1183R	Brunner	17-636	B-2052L	Brunner	17-623
B-1200L	Brunner	17-701	B-2052R	Brunner	17-622
B-1200R	Brunner	17-700	B-2060-23	Eaton	17-699
B-1202L	Brunner	17-703	B-2060-24	Eaton	17-698
B-1202R	Brunner	17-702	B-2460-3	Eaton	17-682
B-1283-10	Eaton	17-598	B-2460-37	Eaton	17-683
B-1283-101	Eaton	17-599	B-2460-38	Eaton	17-682
B-1283-102	Eaton	17-598	B-2460-4	Eaton	17-683
B-1283-9	Eaton	17-599	B-2460-55	Eaton	17-699
B-1691-1	Eaton	17-11071	B-2460-56	Eaton	17-698
B-1691-10	Eaton	17-598	B-2460-85	Eaton	17-682
B-1691-131	Eaton	17-11071	B-2460-86	Eaton	17-683
B-1691-132	Eaton	17-11072	B-3000L	Brunner	18-911
B-1691-17	Eaton	17-583	B-3000R	Brunner	18-910
B-1691-18	Eaton	17-582	B-3020L	Brunner	18-857
B-1691-2	Eaton	17-11072	B-3020R	Brunner	18-856
B-1691-25	Eaton	17-575	B-3024L	Brunner	18-859
B-1691-26	Eaton	17-574	B-3024R	Brunner	18-858
B-1691-45	Eaton	17-579	B-3026L	Brunner	18-873
B-1691-46	Eaton	17-578	B-3026R	Brunner	18-872
B-1691-47	Eaton	17-577	B-3029L	Brunner	18-875
B-1691-48	Eaton	17-576	B-3029R	Brunner	18-874
B-1691-5	Eaton	17-567	B-3050L	Brunner	18-843
B-1691-51	Eaton	17-588	B-3050R	Brunner	18-842
B-1691-52	Eaton	17-589	B-3052L	Brunner	18-841

Manufacturer Number	Manufacturer	Spicer Number	Manufacturer Number	Manufacturer	Spicer Number
B-3052R	Brunner	18-840	B-5000L	Brunner	18-761
B-3056L	Brunner	18-845	B-5000R	Brunner	18-760
B-3056R	Brunner	18-844	B-5006L	Brunner	18-767
B-3058L	Brunner	18-847	B-5006R	Brunner	18-766
B-3058R	Brunner	18-846	B-5010L	Brunner	18-769
B-3059L	Brunner	18-849	B-5010R	Brunner	18-768
B-3059R	Brunner	18-848	B-5014L	Brunner	18-771
B-3060L	Brunner	18-881	B-5014R	Brunner	18-770
B-3060R	Brunner	18-880	B-5018L	Brunner	18-773
B-3062L	Brunner	18-887	B-5018R	Brunner	18-772
B-3062R	Brunner	18-886	B-5022L	Brunner	18-775
B-4002L	Brunner	18-797	B-5022R	Brunner	18-774
B-4002R	Brunner	18-796	B-5026L	Brunner	18-777
B-4004L	Brunner	18-861	B-5026R	Brunner	18-776
B-4004R	Brunner	18-860	B-7008L	Brunner	17-481
B-4005L	Brunner	18-825	B-7008R	Brunner	17-480
B-4005R	Brunner	18-824	B-7012L	Brunner	17-485
B-4006L	Brunner	18-851	B-7012R	Brunner	17-484
B-4006R	Brunner	18-850	B-7016L	Brunner	17-483
B-4008L	Brunner	18-863	B-7016R	Brunner	17-482
B-4008R	Brunner	18-862	CQ66740	Midland	43-7038
B-4010L	Brunner	18-865	CQ66918	Midland	43-7060
B-4010R	Brunner	18-864	CQ66920	Midland	43-7050
B-4014L	Brunner	18-827	CQ66922	Midland	43-7051
B-4014R	Brunner	18-826	CQ67324	Midland	43-7039
B-4018L	Brunner	18-829	CQ67325	Midland	43-7042
B-4018R	Brunner	18-828	CQ67326	Midland	43-7041
B-4022L	Brunner	18-831	CQ67327	Midland	43-7034
B-4022R	Brunner	18-830	CQ67328	Midland	43-7044
B-4024L	Brunner	18-833	CQ67332	Midland	43-7032
B-4024R	Brunner	18-832	CQ67334	Midland	43-7037
B-4025L	Brunner	18-867	CQ67353	Midland	43-7030
B-4025R	Brunner	18-866	CQ67382	Midland	43-7033
B-4030L	Brunner	18-837	CQ67383	Midland	43-7062
B-4030R	Brunner	18-836	CQ67386	Midland	43-7037A
B-4032L	Brunner	18-821	CQ67387	Midland	43-7047
B-4032R	Brunner	18-820	CQ67410	Midland	43-7040
B-4038L	Brunner	18-823	CQ67411	Midland	43-7031
B-4038R	Brunner	18-822	CS41014	Midland	18-809
B-4044L	Brunner	18-835	CS41015	Midland	18-808
B-4044R	Brunner	18-834	CS41016	Midland	18-811
B-4048L	Brunner	18-781	CS41017	Midland	18-810
B-4048R	Brunner	18-780	CS41028	Midland	18-805

CROSS REFERENCE

Manufacturer Number	Manufacturer	Spicer Number	Manufacturer Number	Manufacturer	Spicer Number
CS41029	Midland	18-804	E-10904	Euclid	17-414
CS41292	Midland	17-635	E-10905	Euclid	17-417
CS41293	Midland	17-634	E-10906	Euclid	17-416
CS41504	Midland	17-627	E-10907	Euclid	17-419
CS41505	Midland	17-626	E-10908	Euclid	17-418
CS41506	Midland	17-581	E-10909	Euclid	17-931
CS41507	Midland	17-580	E-10910	Euclid	17-930
CS41512	Midland	17-623	E-10911	Euclid	18-995
CS41513	Midland	17-622	E-10912	Euclid	18-994
CS41522	Midland	17-575	E-10913	Euclid	18-997
CS41523	Midland	17-574	E-10914	Euclid	18-996
CS41528	Midland	17-621	E-10915	Euclid	18-1127
CS41529	Midland	17-620	E-10916	Euclid	18-1128
CS41560	Midland	18-831	E-10917	Euclid	17-11057
CS41561	Midland	18-830	E-10918	Euclid	17-11058
CS41662	Midland	18-833	E-10919	Euclid	17-11059
CS41663	Midland	18-832	E-10920	Euclid	17-11060
CS41718	Midland	17-691	E-10921	Euclid	17-11061
CS41719	Midland	17-690	E-10922	Euclid	17-11062
CS41722	Midland	17-695	E-10923	Euclid	17-11063
CS41723	Midland	17-694	E-10924	Euclid	17-11064
CS41758	Midland	17-631	E-10925	Euclid	17-11065
CS41759	Midland	17-630	E-10926	Euclid	17-11066
CS41762	Midland	17-685	E-10927	Euclid	17-11067
CS41763	Midland	17-684	E-10928	Euclid	17-11068
E-1050	Euclid	18-728	E-10929	Euclid	17-11069
E-1051	Euclid	18-729	E-10930	Euclid	17-11070
E-10859	Euclid	18-987	E-1094	Euclid	17-574
E-10860	Euclid	18-986	E-1095	Euclid	17-575
E-10861	Euclid	18-989	E-1147	Euclid	18-810
E-10862	Euclid	18-988	E-1147A	Euclid	18-810
E-10863	Euclid	18-991	E-1147B	Euclid	18-810
E-10864	Euclid	18-990	E-1148	Euclid	18-811
E-1089	Euclid	18-842	E-1148A	Euclid	18-811
E-10895	Euclid	18-993	E-1148B	Euclid	18-811
E-10896	Euclid	18-992	E-1360	Euclid	18-730
E-10897	Euclid	43-7115	E-1361	Euclid	18-731
E-10899	Euclid	17-11055	E-1393	Euclid	17-682
E-1090	Euclid	18-843	E-1394	Euclid	17-683
E-10900	Euclid	17-11056	E-1410	Euclid	17-684
E-10901	Euclid	17-403	E-1411	Euclid	17-685
E-10902	Euclid	17-402	E-1420	Euclid	17-694
E-10903	Euclid	17-415	E-1421	Euclid	17-695

CROSS REFERENCE

Manufacturer Number	Manufacturer	Spicer Number	Manufacturer Number	Manufacturer	Spicer Number
E-1422	Euclid	17-690	E-2442A	Euclid	17-810
E-1423	Euclid	17-691	E-2443	Euclid	17-629
E-1424	Euclid	17-580	E-2443	Euclid	17-723
E-1425	Euclid	17-581	E-2443A	Euclid	17-629
E-1563	Euclid	17-621	E-2443A	Euclid	17-813
E-1564	Euclid	17-620	E-2444	Euclid	17-628
E-1584	Euclid	17-624	E-2444	Euclid	17-722
E-1585	Euclid	17-625	E-2444A	Euclid	17-628
E-1773A	Euclid	18-808	E-2444A	Euclid	17-812
E-1773B	Euclid	18-808	E-2445	Euclid	17-631
E-1774A	Euclid	18-809	E-2445	Euclid	17-725
E-1774B	Euclid	18-809	E-2445A	Euclid	17-631
E-1775	Euclid	18-738	E-2445A	Euclid	17-815
E-1776	Euclid	18-739	E-2446	Euclid	17-630
E-1788	Euclid	18-784	E-2446	Euclid	17-724
E-1789	Euclid	18-785	E-2446A	Euclid	17-630
E-2086	Euclid	43-7034	E-2446A	Euclid	17-814
E-2086B	Euclid	43-7047	E-2447	Euclid	17-641
E-2087	Euclid	43-7029	E-2448	Euclid	17-640
E-2088	Euclid	43-7044	E-2449	Euclid	17-633
E-2088A	Euclid	43-7044	E-2450	Euclid	17-632
E-2088AHD	Euclid	43-7044	E-2451	Euclid	17-643
E-2089	Euclid	43-7042	E-2452	Euclid	17-642
E-2090	Euclid	43-7039	E-2469	Euclid	43-7033
E-2099	Euclid	17-623	E-2478	Euclid	18-804
E-2100	Euclid	17-622	E-2478A	Euclid	18-804
E-2107	Euclid	17-11071	E-2479	Euclid	18-805
E-2108	Euclid	17-11072	E-2479A	Euclid	18-805
E-2122	Euclid	43-7038	E-2492	Euclid	17-698
E-2123	Euclid	43-7042	E-2493	Euclid	17-699
E-2125	Euclid	43-7041	E-2494	Euclid	43-7040
E-2287	Euclid	43-7032	E-2526	Euclid	43-7030
E-2363	Euclid	43-7044A	E-2679A	Euclid	43-7046
E-2382	Euclid	43-7037	E-2679AHD	Euclid	43-7046
E-2412	Euclid	17-578	E-2680	Euclid	43-7030
E-2413	Euclid	17-579	E-2693	Euclid	17-635
E-2441	Euclid	17-627	E-2694	Euclid	17-634
E-2441	Euclid	17-721	E-2696A	Euclid	43-7043A
E-2441A	Euclid	17-627	E-2700	Euclid	18-806
E-2441A	Euclid	17-811	E-2700A	Euclid	18-806
E-2442	Euclid	17-626	E-2701	Euclid	18-807
E-2442	Euclid	17-720	E-2701A	Euclid	18-807
E-2442A	Euclid	17-626	E-2714	Euclid	18-852

CROSS REFERENCE

Manufacturer Number	Manufacturer	Spicer Number	Manufacturer Number	Manufacturer	Spicer Number
E-2714A	Euclid	18-852	E-3856	Euclid	17-483
E-2715	Euclid	18-853	E-3857	Euclid	17-482
E-2715A	Euclid	18-853	E-3861	Euclid	17-617
E-2730	Euclid	18-910	E-3862	Euclid	17-616
E-2731	Euclid	18-911	E-3876	Euclid	43-7059
E-2786	Euclid	18-740	E-3879	Euclid	18-897
E-2787	Euclid	18-741	E-3880	Euclid	18-896
E-2792	Euclid	17-648	E-3884	Euclid	17-481
E-2793	Euclid	17-649	E-3885	Euclid	17-480
E-2794	Euclid	17-568	E-3989	Euclid	43-7037B
E-2795	Euclid	17-569	E-3989AHD	Euclid	43-7037B
E-2796	Euclid	17-588	E-3993	Euclid	43-7047
E-2797	Euclid	17-589	E-3993A	Euclid	43-7048
E-2799	Euclid	18-726	E-3993B	Euclid	43-7047
E-2800	Euclid	18-727	E-4702A	Euclid	18-786
E-3347	Euclid	18-511	E-4703A	Euclid	18-787
E-3347	Euclid	18-827	E-4704A	Euclid	18-800
E-3348	Euclid	18-510	E-4705A	Euclid	18-801
E-3348	Euclid	18-826	E-4706A	Euclid	18-802
E-3349	Euclid	18-517	E-4707A	Euclid	18-803
E-3349	Euclid	18-831	E-4708	Euclid	18-812
E-3350	Euclid	18-516	E-4708A	Euclid	18-812
E-3350	Euclid	18-830	E-4709	Euclid	18-813
E-3351	Euclid	18-519	E-4709A	Euclid	18-813
E-3351	Euclid	18-833	E-4710	Euclid	18-818
E-3352	Euclid	18-518	E-4710A	Euclid	18-818
E-3352	Euclid	18-832	E-4711	Euclid	18-819
E-3353A	Euclid	43-7053A	E-4711A	Euclid	18-819
E-3446	Euclid	43-7051	E-4712	Euclid	17-570
E-3460	Euclid	18-857	E-4713	Euclid	17-571
E-3461	Euclid	18-856	E-4714	Euclid	17-572
E-3468	Euclid	43-7050	E-4715	Euclid	17-573
E-3468A	Euclid	43-7050	E-4716	Euclid	17-586
E-3516	Euclid	17-701	E-4717	Euclid	17-587
E-3517	Euclid	17-700	E-4718	Euclid	17-596
E-3520A	Euclid	43-7037A	E-4719	Euclid	17-597
E-3520AHD	Euclid	43-7037A	E-4720	Euclid	17-636
E-3523	Euclid	18-747	E-4721	Euclid	17-637
E-3524	Euclid	18-746	E-4722	Euclid	17-638
E-3681	Euclid	17-616	E-4723	Euclid	17-639
E-3682	Euclid	17-617	E-4724	Euclid	18-508
E-3854	Euclid	17-481	E-4724	Euclid	18-864
E-3855	Euclid	17-480	E-4725	Euclid	18-509

CROSS REFERENCE

Manufacturer Number	Manufacturer	Spicer Number	Manufacturer Number	Manufacturer	Spicer Number
E-4725	Euclid	18-865	E-4898	Euclid	18-851
E-4726	Euclid	18-514	E-4899	Euclid	18-850
E-4726	Euclid	18-828	E-4900	Euclid	17-715
E-4727	Euclid	18-515	E-4901	Euclid	17-714
E-4727	Euclid	18-829	E-4906	Euclid	18-877
E-4728	Euclid	18-526	E-4907	Euclid	18-876
E-4728	Euclid	18-836	E-4912	Euclid	18-1129
E-4729	Euclid	18-527	E-4913	Euclid	18-1130
E-4729	Euclid	18-837	E-4916	Euclid	18-859
E-4730	Euclid	18-528	E-4917	Euclid	18-858
E-4730	Euclid	18-820	E-4918	Euclid	18-873
E-4731	Euclid	18-529	E-4919	Euclid	18-872
E-4731	Euclid	18-821	E-4936	Euclid	18-875
E-4732	Euclid	18-530	E-4937	Euclid	18-874
E-4732	Euclid	18-532	E-4940	Euclid	18-845
E-4732	Euclid	18-822	E-4941	Euclid	18-844
E-4733	Euclid	18-531	E-4991	Euclid	18-849
E-4733	Euclid	18-533	E-4992	Euclid	18-848
E-4733	Euclid	18-823	E-4993	Euclid	18-883
E-4734	Euclid	18-534	E-4994	Euclid	18-882
E-4734	Euclid	18-834	E-4995	Euclid	18-881
E-4735	Euclid	18-535	E-4996	Euclid	18-880
E-4735	Euclid	18-835	E-4997	Euclid	18-885
E-4740	Euclid	18-743	E-4998	Euclid	18-884
E-4741	Euclid	18-742	E-4999	Euclid	18-861
E-4884	Euclid	17-595	E-5000	Euclid	18-860
E-4885	Euclid	17-594	E-5003	Euclid	18-799
E-4886	Euclid	18-735	E-5004	Euclid	18-798
E-4887	Euclid	18-734	E-5056	Euclid	18-854
E-4888	Euclid	18-749	E-5057	Euclid	18-855
E-4889	Euclid	18-748	E-5058	Euclid	18-761
E-4890	Euclid	17-619	E-5059	Euclid	18-760
E-4891	Euclid	17-618	E-5060	Euclid	18-767
E-4892	Euclid	17-611	E-5061	Euclid	18-766
E-4893	Euclid	17-610	E-5062	Euclid	18-777
E-4894	Euclid	18-525	E-5063	Euclid	18-776
E-4894	Euclid	18-869	E-5064	Euclid	18-765
E-4895	Euclid	18-524	E-5065	Euclid	18-764
E-4895	Euclid	18-868	E-5066	Euclid	18-769
E-4896	Euclid	18-505	E-5067	Euclid	18-768
E-4896	Euclid	18-825	E-5068	Euclid	18-779
E-4897	Euclid	18-504	E-5069	Euclid	18-778
E-4897	Euclid	18-824	E-5096	Euclid	17-681

CROSS REFERENCE

Manufacturer Number	Manufacturer	Spicer Number	Manufacturer Number	Manufacturer	Spicer Number
E-5097	Euclid	17-680	E-5529	Euclid	18-897
E-5098	Euclid	18-841	E-5530	Euclid	18-896
E-5099	Euclid	18-840	E-556	Euclid	17-580
E-5129	Euclid	18-763	E-557	Euclid	17-581
E-5130	Euclid	18-762	E-6078	Euclid	43-7072A
E-5131	Euclid	18-771	E-6081	Euclid	17-661
E-5132	Euclid	18-770	E-6082	Euclid	17-660
E-5133	Euclid	18-773	E-6089	Euclid	17-661
E-5134	Euclid	18-772	E-6090	Euclid	17-660
E-5135	Euclid	18-775	E-6101	Euclid	17-519
E-5136	Euclid	18-774	E-6102	Euclid	17-518
E-5140	Euclid	43-7060	E-6103	Euclid	17-555
E-5307	Euclid	43-7062	E-6104	Euclid	17-554
E-5490	Euclid	18-941	E-684	Euclid	17-582
E-5491	Euclid	18-940	E-685	Euclid	17-583
E-5492	Euclid	18-943	E-686	Euclid	17-576
E-5493	Euclid	18-942	E-687	Euclid	17-577
E-5494	Euclid	17-461	E-688	Euclid	17-566
E-5495	Euclid	17-460	E-6880	Euclid	18-817
E-5496	Euclid	17-463	E-6881	Euclid	18-816
E-5497	Euclid	17-462	E-6882	Euclid	18-521
E-5501	Euclid	43-7069	E-6882	Euclid	18-867
E-5504	Euclid	18-931	E-6883	Euclid	18-520
E-5505	Euclid	18-930	E-6883	Euclid	18-866
E-5506	Euclid	17-721	E-6884	Euclid	17-485
E-5507	Euclid	17-720	E-6885	Euclid	17-484
E-5508	Euclid	17-723	E-689	Euclid	17-567
E-5509	Euclid	17-722	E-690	Euclid	17-598
E-5510	Euclid	17-725	E-691	Euclid	17-599
E-5511	Euclid	17-724	E-7217	Euclid	17-591
E-5513	Euclid	43-7048A	E-7218	Euclid	17-590
E-5516	Euclid	17-517	E-7219	Euclid	17-593
E-5517	Euclid	17-516	E-7220	Euclid	17-592
E-5518	Euclid	17-505	E-7233	Euclid	18-705
E-5519	Euclid	17-504	E-7234	Euclid	18-704
E-5520	Euclid	17-509	E-7235	Euclid	43-7064
E-5521	Euclid	17-508	E-7239	Euclid	18-709
E-5522	Euclid	17-513	E-7240	Euclid	18-708
E-5523	Euclid	17-512	E-7241	Euclid	43-7065
E-5524	Euclid	17-501	E-821	Euclid	18-840
E-5525	Euclid	17-500	E-822	Euclid	18-841
E-5526	Euclid	17-503	E-9028	Euclid	18-963
E-5527	Euclid	17-502	E-9029	Euclid	18-962

CROSS REFERENCE

Manufacturer Number	Manufacturer	Spicer Number	Manufacturer Number	Manufacturer	Spicer Number
E-9030	Euclid	18-973	E-9264	Euclid	17-734
E-9031	Euclid	18-972	E-9265	Euclid	17-745
E-9032	Euclid	18-975	E-9266	Euclid	17-744
E-9033	Euclid	18-974	E-9267	Euclid	17-751
E-9034	Euclid	18-977	E-9268	Euclid	17-750
E-9034	Euclid	18-979	E-9269	Euclid	17-755
E-9035	Euclid	18-976	E-9270	Euclid	17-754
E-9035	Euclid	18-978	E-9271	Euclid	17-757
E-9053	Euclid	43-7068	E-9272	Euclid	17-756
E-9055	Euclid	18-745	E-9273	Euclid	17-739
E-9056	Euclid	18-744	E-9273	Euclid	17-761
E-9057	Euclid	17-471	E-9274	Euclid	17-738
E-9058	Euclid	17-470	E-9274	Euclid	17-760
E-9059	Euclid	17-473	E-9275	Euclid	17-763
E-9060	Euclid	17-472	E-9276	Euclid	17-762
E-9065	Euclid	18-937	E-9277	Euclid	17-765
E-9066	Euclid	18-936	E-9278	Euclid	17-764
E-9067	Euclid	18-939	E-9279	Euclid	17-771
E-9068	Euclid	18-938	E-9280	Euclid	17-770
E-9078HD	Euclid	43-7071	E-9645	Euclid	18-501
E-9079HD	Euclid	43-7072	E-9646	Euclid	18-500
E-9080	Euclid	43-7048	E-9647	Euclid	18-503
E-9081	Euclid	18-781	E-9648	Euclid	18-502
E-9082	Euclid	18-780	E-9649	Euclid	18-505
E-9083	Euclid	18-713	E-9650	Euclid	18-504
E-9084	Euclid	18-712	E-9651	Euclid	18-507
E-9085	Euclid	18-717	E-9652	Euclid	18-506
E-9086	Euclid	18-716	E-9653	Euclid	18-509
E-9087	Euclid	17-703	E-9654	Euclid	18-508
E-9088	Euclid	17-702	E-9655	Euclid	18-511
E-9089	Euclid	17-585	E-9656	Euclid	18-510
E-9090	Euclid	17-584	E-9657	Euclid	18-515
E-9091	Euclid	17-657	E-9658	Euclid	18-514
E-9092	Euclid	17-656	E-9659	Euclid	18-517
E-9093	Euclid	17-659	E-9660	Euclid	18-516
E-9094	Euclid	17-658	E-9661	Euclid	18-519
E-9096	Euclid	17-531	E-9662	Euclid	18-518
E-9097	Euclid	17-530	E-9663	Euclid	18-521
E-9098	Euclid	17-511	E-9664	Euclid	18-520
E-9099	Euclid	17-510	E-9665	Euclid	18-523
E-9100	Euclid	17-515	E-9666	Euclid	18-522
E-9101	Euclid	17-514	E-9667	Euclid	18-525
E-9263	Euclid	17-735	E-9668	Euclid	18-524

CROSS REFERENCE

Manufacturer Number	Manufacturer	Spicer Number	Manufacturer Number	Manufacturer	Spicer Number
E-9669	Euclid	18-527	E-9712	Euclid	18-900
E-9670	Euclid	18-526	E-9713	Euclid	18-905
E-9671	Euclid	18-529	E-9714	Euclid	18-904
E-9672	Euclid	18-528	E-9715	Euclid	18-907
E-9673	Euclid	18-531	E-9716	Euclid	18-906
E-9673A	Euclid	18-533	E-9717	Euclid	18-909
E-9674	Euclid	18-530	E-9718	Euclid	18-908
E-9674A	Euclid	18-532	E-9725	Euclid	17-479
E-9675	Euclid	18-535	E-9726	Euclid	17-478
E-9676	Euclid	18-534	E-9727	Euclid	17-507
E-9677	Euclid	18-537	E-9728	Euclid	17-506
E-9678	Euclid	18-536	E-9729	Euclid	17-523
E-9679	Euclid	18-539	E-9730	Euclid	17-522
E-9680	Euclid	18-538	E-9731	Euclid	17-915
E-9681	Euclid	18-541	E-9732	Euclid	17-914
E-9682	Euclid	18-540	E-9733	Euclid	17-921
E-9683	Euclid	18-543	E-9734	Euclid	17-920
E-9684	Euclid	18-542	E-9735	Euclid	17-929
E-9687	Euclid	18-795	E-9736	Euclid	17-928
E-9688	Euclid	18-794	E-9737	Euclid	17-941
E-9689	Euclid	18-725	E-9738	Euclid	17-940
E-9690	Euclid	18-724	E-9739	Euclid	17-537
E-9691	Euclid	18-791	E-9740	Euclid	17-536
E-9692	Euclid	18-790	E-9741	Euclid	17-557
E-9693	Euclid	18-955	E-9742	Euclid	17-556
E-9694	Euclid	18-954	E-9743	Euclid	17-677
E-9695	Euclid	18-951	E-9744	Euclid	17-676
E-9696	Euclid	18-950	E-9745	Euclid	17-693
E-9697	Euclid	18-953	E-9746	Euclid	17-692
E-9698	Euclid	18-952	E-9747	Euclid	17-697
E-9699	Euclid	18-957	E-9748	Euclid	17-696
E-9700	Euclid	18-956	E-9749	Euclid	17-741
E-9701	Euclid	18-959	E-9750	Euclid	17-740
E-9702	Euclid	18-958	E-9751	Euclid	17-737
E-9703	Euclid	18-949	E-9752	Euclid	17-736
E-9704	Euclid	18-948	E-9753	Euclid	17-795
E-9705	Euclid	18-891	E-9754	Euclid	17-794
E-9706	Euclid	18-890	E-9755	Euclid	17-787
E-9707	Euclid	18-893	E-9756	Euclid	17-786
E-9708	Euclid	18-892	E-9757	Euclid	17-797
E-9709	Euclid	17-561	E-9758	Euclid	17-796
E-9710	Euclid	17-560	E-9759	Euclid	17-417
E-9711	Euclid	18-901	E-9759	Euclid	17-783

Manufacturer Number	Manufacturer	Spicer Number	Manufacturer Number	Manufacturer	Spicer Number
E-9760	Euclid	17-416	ETN0 820 078	Navistar	17-574
E-9760	Euclid	17-782	ETN0 820 080	Navistar	17-575
E-9761	Euclid	17-615	ETN0 820 083	Navistar	17-586
E-9762	Euclid	17-614	ETN0 820 084	Navistar	17-587
E-9763	Euclid	18-733	ETN0 820 239	Navistar	17-698
E-9764	Euclid	18-732	ETN0 820 243	Navistar	17-699
E-9765	Euclid	18-737	ETN0 820 244	Navistar	17-698
E-9766	Euclid	18-736	ETN1 000 087	Navistar	18-727
E-9767	Euclid	18-983	ETN1 000 088	Navistar	18-726
E-9768	Euclid	18-982	ETN1 000 839	Navistar	18-749
E-9769	Euclid	18-985	ETN1 000 840	Navistar	18-748
E-9770	Euclid	18-984	ETN1 001 580	Navistar	18-747
E-9771	Euclid	18-945	ETN1 001 581	Navistar	18-746
E-9772	Euclid	18-944	ETN1 001 722	Navistar	18-751
E-9790A	Euclid	43-7118	ETN1 001 723	Navistar	18-750
E-9791HD	Euclid	43-7090	ETN1 006 726	Navistar	18-763
ENT0 089 163	Navistar	18-753	ETN1 006 727	Navistar	18-762
ENT0 820 240	Navistar	17-699	ETN1 006 728	Navistar	18-773
ETN0 035 430	Navistar	18-745	ETN1 006 729	Navistar	18-772
ETN0 035 431	Navistar	18-744	ETN1 006 730	Navistar	18-767
ETN0 035 455	Navistar	18-743	ETN1 006 731	Navistar	18-766
ETN0 035 456	Navistar	18-742	ETN1 006 864	Navistar	18-777
ETN0 039 379	Navistar	18-731	ETN1 006 865	Navistar	18-776
ETN0 039 380	Navistar	18-730	ETN1 006 866	Navistar	18-771
ETN0 040 686	Navistar	18-729	ETN1 006 867	Navistar	18-770
ETN0 040 687	Navistar	18-728	ETN1 006 940	Navistar	18-775
ETN0 070 306	Navistar	18-739	ETN1 006 941	Navistar	18-774
ETN0 070 307	Navistar	18-738	ETN1 008 006	Navistar	18-769
ETN0 070 308	Navistar	18-735	ETN1 008 007	Navistar	18-768
ETN0 070 309	Navistar	18-734	F89680	Wagner	18-911
ETN0 071 306	Navistar	18-741	F89681	Wagner	18-910
ETN0 071 307	Navistar	18-740	FC31944	Wagner	18-848
ETN0 076 293	Navistar	18-737	FC31945	Wagner	18-849
ETN0 076 294	Navistar	18-736	FE31944	Wagner	18-852
ETN0 089 164	Navistar	18-752	FE31945	Wagner	18-853
ETN0 125 030	Navistar	17-637	H-10002L	Hercules	18-805
ETN0 125 031	Navistar	17-636	H-10003R	Hercules	18-804
ETN0 125 034	Navistar	17-635	H-10004L	Hercules	18-807
ETN0 125 035	Navistar	17-634	H-10005R	Hercules	18-806
ETN0 125 042	Navistar	17-638	H-10006L	Hercules	18-855
ETN0 125 043	Navistar	17-639	H-10007R	Hercules	18-854
ETN0 806 526	Navistar	18-943	H-10008L	Hercules	18-729
ETN0 806 527	Navistar	18-942	H-10009R	Hercules	18-728

CROSS REFERENCE

Manufacturer Number	Manufacturer	Spicer Number	Manufacturer Number	Manufacturer	Spicer Number
H-10010L	Hercules	18-785	H-10053R	Hercules	18-746
H-10011R	Hercules	18-784	H-10054L	Hercules	18-743
H-10012L	Hercules	18-795	H-10055R	Hercules	18-742
H-10013R	Hercules	18-794	H-10056L	Hercules	18-745
H-10014L	Hercules	18-809	H-10057R	Hercules	18-744
H-10015R	Hercules	18-808	H-10058L	Hercules	18-755
H-10016L	Hercules	18-811	H-10059R	Hercules	18-754
H-10017R	Hercules	18-810	H-10060L	Hercules	18-793
H-10018L	Hercules	18-725	H-10061R	Hercules	18-792
H-10019R	Hercules	18-724	H-10062L	Hercules	18-783
H-10020L	Hercules	17-611	H-10063R	Hercules	18-782
H-10021R	Hercules	17-610	H-10064L	Hercules	18-815
H-10022L	Hercules	18-801	H-10065R	Hercules	18-814
H-10023R	Hercules	18-800	H-10066L	Hercules	17-543
H-10024L	Hercules	18-803	H-10067R	Hercules	17-542
H-10025R	Hercules	18-802	H-10068L	Hercules	17-545
H10026L	Hercules	18-727	H-10069R	Hercules	17-544
H-10027R	Hercules	18-726	H-10070L	Hercules	17-547
H-10028L	Hercules	18-733	H-10071R	Hercules	17-546
H-10029R	Hercules	18-732	H-10072L	Hercules	17-549
H-10030L	Hercules	18-737	H-10073R	Hercules	17-548
H-10031R	Hercules	18-736	H-10074L	Hercules	17-551
H-10032L	Hercules	18-735	H-10075R	Hercules	17-550
H-10033R	Hercules	18-734	H-10076L	Hercules	17-563
H-10034L	Hercules	18-791	H-10077R	Hercules	17-562
H-10035R	Hercules	18-790	H-10078L	Hercules	17-553
H-10036L	Hercules	18-787	H-10079R	Hercules	17-552
H-10037R	Hercules	18-786	H-10080L	Hercules	17-535
H-10038L	Hercules	17-561	H-10081R	Hercules	17-534
H-10039R	Hercules	17-560	H-10082L	Hercules	17-539
H-10040L	Hercules	18-751	H-10083R	Hercules	17-538
H-10041R	Hercules	18-750	H-10084L	Hercules	17-559
H-10042L	Hercules	18-741	H-10085R	Hercules	17-558
H-10043R	Hercules	18-740	H-10086L	Hercules	17-565
H-10044L	Hercules	18-813	H-10087R	Hercules	17-564
H-10045R	Hercules	18-812	H-10088L	Hercules	17-541
H-10046L	Hercules	18-749	H-10089R	Hercules	17-540
H-10047R	Hercules	18-748	H-10090L	Hercules	17-521
H-10048L	Hercules	18-817	H-10091R	Hercules	17-520
H-10049R	Hercules	18-816	H-10092L	Hercules	17-525
H-10050L	Hercules	18-753	H-10093R	Hercules	17-524
H-10051R	Hercules	18-752	H-10094L	Hercules	17-491
H-10052L	Hercules	18-747	H-10095R	Hercules	17-490

CROSS REFERENCE

Manufacturer Number	Manufacturer	Spicer Number	Manufacturer Number	Manufacturer	Spicer Number
H-10096L	Hercules	17-493	H-10139R	Hercules	17-556
H-10097R	Hercules	17-492	H-10140L	Hercules	17-687
H-10098L	Hercules	17-527	H-10141R	Hercules	17-686
H-10099R	Hercules	17-526	H-10142L	Hercules	17-711
H-10100L	Hercules	17-685	H-10143R	Hercules	17-710
H-10101R	Hercules	17-684	H-10144L	Hercules	17-707
H-10102L	Hercules	17-695	H-10145R	Hercules	17-706
H-10103R	Hercules	17-694	H-10146L	Hercules	17-709
H-10104L	Hercules	17-691	H-10147R	Hercules	17-708
H-10105R	Hercules	17-690	H-10148L	Hercules	18-893
H-10106L	Hercules	17-649	H-10148L	Hercules	18-895
H-10107R	Hercules	17-648	H-10149R	Hercules	18-892
H-10108L	Hercules	17-681	H-10149R	Hercules	18-894
H-10109R	Hercules	17-680	H-10150L	Hercules	17-531
H-10110L	Hercules	17-683	H-10151R	Hercules	17-530
H-10111R	Hercules	17-682	H-10152L	Hercules	17-513
H-10112L	Hercules	17-699	H-10153R	Hercules	17-512
H-10113R	Hercules	17-698	H-10154L	Hercules	17-501
H-10114L	Hercules	17-677	H-10155R	Hercules	17-500
H-10115R	Hercules	17-676	H-10156L	Hercules	17-511
H-10116L	Hercules	17-697	H-10157R	Hercules	17-510
H-10117R	Hercules	17-696	H-10158L	Hercules	17-503
H-10118L	Hercules	17-693	H-10159R	Hercules	17-502
H-10119R	Hercules	17-692	H-10160L	Hercules	17-529
H-10120L	Hercules	17-679	H-10161R	Hercules	17-528
H-10121R	Hercules	17-678	H-10162L	Hercules	17-515
H-10122L	Hercules	17-689	H-10163R	Hercules	17-514
H-10123R	Hercules	17-688	H-10166L	Hercules	17-523
H-10124L	Hercules	17-517	H-10167R	Hercules	17-522
H-10125R	Hercules	17-516	H-10168L	Hercules	17-915
H-10126L	Hercules	17-505	H-10169R	Hercules	17-914
H-10127R	Hercules	17-504	H-10170L	Hercules	17-921
H-10128L	Hercules	17-519	H-10171R	Hercules	17-920
H-10129R	Hercules	17-518	H-10172L	Hercules	17-929
H-10130L	Hercules	17-509	H-10173R	Hercules	17-928
H-10131R	Hercules	17-508	H-10174L	Hercules	17-941
H-10132L	Hercules	17-507	H-10175R	Hercules	17-940
H-10133R	Hercules	17-506	H-10176L	Hercules	17-931
H-10134L	Hercules	17-555	H-10177R	Hercules	17-930
H-10135R	Hercules	17-554	H-10178L	Hercules	17-439
H-10136L	Hercules	17-537	H-10179R	Hercules	17-438
H-10137R	Hercules	17-536	H-10180L	Hercules	17-443
H-10138L	Hercules	17-557	H-10181R	Hercules	17-442

CROSS REFERENCE

Manufacturer Number	Manufacturer	Spicer Number	Manufacturer Number	Manufacturer	Spicer Number
H-10182L	Hercules	18-955	H-10217R	Hercules	18-982
H-10183R	Hercules	18-954	H-10218L	Hercules	18-943
H-10184L	Hercules	18-857	H-10219R	Hercules	18-942
H-10184L	Hercules	18-951	H-10220L	Hercules	18-985
H-10185R	Hercules	18-856	H-10221R	Hercules	18-984
H-10185R	Hercules	18-950	H-10222L	Hercules	18-945
H-10186L	Hercules	18-859	H-10223R	Hercules	18-944
H-10186L	Hercules	18-953	H-10224L	Hercules	17-471
H-10187R	Hercules	18-858	H-10225R	Hercules	17-470
H-10187R	Hercules	18-952	H-10226L	Hercules	17-473
H-10188L	Hercules	18-873	H-10227R	Hercules	17-472
H-10188L	Hercules	18-957	H-10228L	Hercules	17-461
H-10189R	Hercules	18-872	H-10229R	Hercules	17-460
H-10189R	Hercules	18-956	H-10230L	Hercules	17-463
H-10190L	Hercules	18-875	H-10231R	Hercules	17-462
H-10190L	Hercules	18-959	H-10250L	Hercules	18-853
H-10191R	Hercules	18-874	H-10251R	Hercules	18-852
H-10191R	Hercules	18-958	H-10252L	Hercules	18-621
H-10192L	Hercules	18-877	H-10253R	Hercules	18-620
H-10192L	Hercules	18-949	H-10254L	Hercules	18-623
H-10193R	Hercules	18-876	H-10255R	Hercules	18-622
H-10193R	Hercules	18-948	H-10256L	Hercules	18-625
H-10194L	Hercules	18-891	H-10257R	Hercules	18-624
H-10195R	Hercules	18-890	H-10258L	Hercules	18-627
H-10198L	Hercules	18-897	H-10259R	Hercules	18-626
H-10199R	Hercules	18-896	H-10260L	Hercules	18-819
H-10200L	Hercules	18-899	H-10261R	Hercules	18-818
H-10200L	Hercules	18-901	H-10264L	Hercules	17-577
H-10201R	Hercules	18-898	H-10265R	Hercules	17-576
H-10201R	Hercules	18-900	H-10266L	Hercules	17-569
H-10202L	Hercules	18-905	H-10267R	Hercules	17-568
H-10203R	Hercules	18-904	H-10268L	Hercules	17-571
H-10204L	Hercules	18-907	H-10269R	Hercules	17-570
H-10205R	Hercules	18-906	H-10270L	Hercules	18-629
H-10206L	Hercules	18-909	H-10271R	Hercules	18-628
H-10207R	Hercules	18-908	H-10272L	Hercules	18-631
H-10208L	Hercules	18-903	H-10273R	Hercules	18-630
H-10209R	Hercules	18-902	H-10274L	Hercules	18-635
H-10212L	Hercules	18-947	H-10275R	Hercules	18-634
H-10213R	Hercules	18-946	H-10276L	Hercules	17-641
H-10214L	Hercules	18-941	H-10277R	Hercules	17-640
H-10215R	Hercules	18-940	H-10278L	Hercules	17-573
H-10216L	Hercules	18-983	H-10279R	Hercules	17-572

Manufacturer Number	Manufacturer	Spicer Number	Manufacturer Number	Manufacturer	Spicer Number
H-10284L	Hercules	17-567	H-10445R	Hercules	17-760
H-10285R	Hercules	17-566	H-10446L	Hercules	17-767
H-10292L	Hercules	17-635	H-10447R	Hercules	17-766
H-10293R	Hercules	17-634	H-10448L	Hercules	17-769
H-10370L	Hercules	17-701	H-10449R	Hercules	17-768
H-10371R	Hercules	17-700	H-10450L	Hercules	17-735
H-10372L	Hercules	17-703	H-10451R	Hercules	17-734
H-10373R	Hercules	17-702	H-10452L	Hercules	17-737
H-10380L	Hercules	17-715	H-10453R	Hercules	17-736
H-10381R	Hercules	17-714	H-10454L	Hercules	17-741
H-10400L	Hercules	18-861	H-10455R	Hercules	17-740
H-10401R	Hercules	18-860	H-10456L	Hercules	17-745
H-10402L	Hercules	18-799	H-10457R	Hercules	17-744
H-10403R	Hercules	18-798	H-10458L	Hercules	17-751
H-10404L	Hercules	18-867	H-10459R	Hercules	17-750
H-10405R	Hercules	18-866	H-10460L	Hercules	17-755
H-10406L	Hercules	18-797	H-10461R	Hercules	17-754
H-10407R	Hercules	18-796	H-10462L	Hercules	17-757
H-10408L	Hercules	18-863	H-10463R	Hercules	17-756
H-10409R	Hercules	18-862	H-10464L	Hercules	17-739
H-10410L	Hercules	18-889	H-10465R	Hercules	17-738
H-10411R	Hercules	18-888	H-10466L	Hercules	17-763
H-10412L	Hercules	18-711	H-10467R	Hercules	17-762
H-10413R	Hercules	18-710	H-10468L	Hercules	17-765
H-10414L	Hercules	18-715	H-10469R	Hercules	17-764
H-10415R	Hercules	18-714	H-10470L	Hercules	17-771
H-10416L	Hercules	17-479	H-10471R	Hercules	17-770
H-10417R	Hercules	17-478	H-10472L	Hercules	17-773
H-10418L	Hercules	17-481	H-10473R	Hercules	17-772
H-10419R	Hercules	17-480	H-10474L	Hercules	17-785
H-10420L	Hercules	17-485	H-10475R	Hercules	17-784
H-10421R	Hercules	17-484	H-10476L	Hercules	17-789
H-10422L	Hercules	17-483	H-10477R	Hercules	17-788
H-10423R	Hercules	17-482	H-10478L	Hercules	17-793
H-10436L	Hercules	17-747	H-10479R	Hercules	17-792
H-10437R	Hercules	17-746	H-10480L	Hercules	17-795
H-10438L	Hercules	17-749	H-10481R	Hercules	17-794
H-10439R	Hercules	17-748	H-10482L	Hercules	17-787
H-10440L	Hercules	17-753	H-10483R	Hercules	17-786
H-10441R	Hercules	17-752	H-10484L	Hercules	17-797
H-10442L	Hercules	17-759	H-10485R	Hercules	17-796
H-10443R	Hercules	17-758	H-10486L	Hercules	17-783
H-10444L	Hercules	17-761	H-10487R	Hercules	17-782

CROSS REFERENCE

Manufacturer Number	Manufacturer	Spicer Number	Manufacturer Number	Manufacturer	Spicer Number
H-10488L	Hercules	17-781	H-10559R	Hercules	18-828
H-10489R	Hercules	17-780	H-10560L	Hercules	18-831
H-10490L	Hercules	17-779	H-10561R	Hercules	18-830
H-10491R	Hercules	17-778	H-10562L	Hercules	18-833
H-10492L	Hercules	17-799	H-10563R	Hercules	18-832
H-10493R	Hercules	17-798	H-10564L	Hercules	18-869
H-10494L	Hercules	17-805	H-10565R	Hercules	18-868
H-10495R	Hercules	17-804	H-10566L	Hercules	18-837
H-10504L	Hercules	17-627	H-10567R	Hercules	18-836
H-10505R	Hercules	17-626	H-10568L	Hercules	18-821
H-10506L	Hercules	17-581	H-10569R	Hercules	18-820
H-10507R	Hercules	17-580	H-10570L	Hercules	17-595
H-10512L	Hercules	17-623	H-10571R	Hercules	17-594
H-10513R	Hercules	17-622	H-10572L	Hercules	17-591
H-10514L	Hercules	17-583	H-10573R	Hercules	17-590
H-10515R	Hercules	17-582	H-10574L	Hercules	17-593
H-10516L	Hercules	17-599	H-10575R	Hercules	17-592
H-10517R	Hercules	17-598	H-10578L	Hercules	18-641
H-10522L	Hercules	17-575	H-10579R	Hercules	18-640
H-10523R	Hercules	17-574	H-10580L	Hercules	18-643
H-10526L	Hercules	17-629	H-10581R	Hercules	18-642
H-10527R	Hercules	17-628	H-10582L	Hercules	18-645
H-10528L	Hercules	17-621	H-10583R	Hercules	18-644
H-10529R	Hercules	17-620	H-10584L	Hercules	18-647
H-10532L	Hercules	17-633	H-10585R	Hercules	18-646
H-10533R	Hercules	17-632	H-10587R	Hercules	18-648
H-10542L	Hercules	17-585	H-10588L	Hercules	18-651
H-10543R	Hercules	17-584	H-10589R	Hercules	18-650
H-10544L	Hercules	17-637	H-10590L	Hercules	18-653
H-10545R	Hercules	17-636	H-10591R	Hercules	18-652
H-10546L	Hercules	17-587	H-10592L	Hercules	18-655
H-10547R	Hercules	17-586	H-10593R	Hercules	18-654
H-10548L	Hercules	17-639	H-10594L	Hercules	18-657
H-10549R	Hercules	17-638	H-10595R	Hercules	18-656
H-10550L	Hercules	18-825	H-10596L	Hercules	18-659
H-10551R	Hercules	18-824	H-10597R	Hercules	18-658
H-10552L	Hercules	18-851	H-10598L	Hercules	18-661
H-10553R	Hercules	18-850	H-10599R	Hercules	18-660
H-10554L	Hercules	18-865	H-10600L	Hercules	18-761
H-10555R	Hercules	18-864	H-10601R	Hercules	18-760
H-10556L	Hercules	18-827	H-10602L	Hercules	18-763
H-10557R	Hercules	18-826	H-10603R	Hercules	18-762
H-10558L	Hercules	18-829	H-10604L	Hercules	18-765

Manufacturer Number	Manufacturer	Spicer Number	Manufacturer Number	Manufacturer	Spicer Number
H-10605R	Hercules	18-764	H-10648L	Hercules	17-869
H-10606L	Hercules	18-767	H-10649R	Hercules	17-868
H-10607R	Hercules	18-766	H-10650L	Hercules	17-871
H-10608L	Hercules	18-769	H-10651R	Hercules	17-870
H-10609R	Hercules	18-768	H-10660L	Hercules	17-873
H-10610L	Hercules	18-771	H-10661R	Hercules	17-872
H-10611R	Hercules	18-770	H-10666L	Hercules	17-881
H-10612L	Hercules	18-773	H-10667R	Hercules	17-880
H-10613R	Hercules	18-772	H-10700L	Hercules	17-913
H-10614L	Hercules	18-775	H-10701R	Hercules	17-912
H-10615R	Hercules	18-774	H-10702L	Hercules	17-925
H-10616L	Hercules	18-777	H-10703R	Hercules	17-924
H-10617R	Hercules	18-776	H-10704L	Hercules	17-927
H-10618L	Hercules	18-779	H-10705R	Hercules	17-926
H-10619R	Hercules	18-778	H-10706L	Hercules	17-937
H-10620R	Hercules	17-841	H-10707R	Hercules	17-936
H-10621L	Hercules	17-840	H-10708L	Hercules	17-947
H-10622L	Hercules	17-843	H-10709R	Hercules	17-946
H-10623R	Hercules	17-842	H-10710L	Hercules	18-671
H-10624L	Hercules	17-845	H-10711R	Hercules	18-670
H-10625R	Hercules	17-844	H-10712L	Hercules	18-673
H-10626L	Hercules	17-847	H-10713R	Hercules	18-672
H-10627R	Hercules	17-846	H-10714L	Hercules	18-675
H-10628L	Hercules	17-849	H-10715R	Hercules	18-674
H-10629R	Hercules	17-848	H-10716L	Hercules	18-677
H-10630L	Hercules	17-851	H-10717R	Hercules	18-676
H-10631R	Hercules	17-850	H-10718L	Hercules	18-679
H-10632L	Hercules	17-853	H-10719R	Hercules	18-678
H-10633R	Hercules	17-852	H-10720L	Hercules	18-681
H-10634L	Hercules	17-855	H-10721R	Hercules	18-680
H-10635R	Hercules	17-854	H-10722L	Hercules	18-683
H-10636L	Hercules	17-857	H-10723R	Hercules	18-682
H-10637R	Hercules	17-856	H-10724L	Hercules	18-685
H-10638L	Hercules	17-859	H-10725R	Hercules	18-684
H-10639R	Hercules	17-858	H-10726L	Hercules	18-689
H-10640L	Hercules	17-861	H-10727R	Hercules	18-688
H-10641R	Hercules	17-860	H-10728L	Hercules	17-961
H-10642L	Hercules	17-863	H-10729R	Hercules	17-960
H-10643R	Hercules	17-862	H-10730L	Hercules	17-963
H-10644L	Hercules	17-865	H-10731R	Hercules	17-962
H-10645R	Hercules	17-864	H-10732L	Hercules	17-965
H-10646L	Hercules	17-867	H-10733R	Hercules	17-964
H-10647R	Hercules	17-866	H-10734L	Hercules	17-967

CROSS REFERENCE

Manufacturer Number	Manufacturer	Spicer Number	Manufacturer Number	Manufacturer	Spicer Number
H-10735R	Hercules	17-966	H-10778L	Hercules	18-717
H-10736L	Hercules	17-969	H-10779R	Hercules	18-716
H-10737R	Hercules	17-968	H-10780L	Hercules	17-989
H-10738L	Hercules	17-971	H-10781R	Hercules	17-988
H-10739R	Hercules	17-970	H-10782L	Hercules	17-991
H-10740L	Hercules	17-973	H-10783R	Hercules	17-990
H-10741R	Hercules	17-972	H-10784L	Hercules	17-993
H-10742L	Hercules	17-975	H-10785R	Hercules	17-992
H-10743R	Hercules	17-974	H-10786L	Hercules	17-995
H-10744L	Hercules	17-977	H-10787R	Hercules	17-994
H-10745R	Hercules	17-976	H-10788L	Hercules	18-731
H-10746L	Hercules	17-979	H-10789R	Hercules	18-730
H-10747R	Hercules	17-978	H-10790L	Hercules	18-879
H-10748L	Hercules	17-981	H-10791R	Hercules	18-878
H-10749R	Hercules	17-980	H-10810L	Hercules	18-961
H-10750L	Hercules	17-997	H-10811R	Hercules	18-960
H-10751R	Hercules	17-996	H-10812L	Hercules	17-617
H-10752L	Hercules	17-643	H-10813R	Hercules	17-616
H-10753R	Hercules	17-642	H-10814L	Hercules	17-619
H-10754L	Hercules	17-589	H-10815R	Hercules	17-618
H-10755R	Hercules	17-588	H-10816L	Hercules	17-625
H-10756L	Hercules	17-597	H-10817R	Hercules	17-624
H-10757R	Hercules	17-596	H-10818L	Hercules	17-615
H-10758L	Hercules	17-631	H-10819R	Hercules	17-614
H-10759R	Hercules	17-630	H-10820L	Hercules	18-965
H-10760L	Hercules	18-739	H-10821R	Hercules	18-964
H-10761R	Hercules	18-738	H-10822L	Hercules	18-967
H-10762L	Hercules	17-983	H-10823R	Hercules	18-966
H-10763R	Hercules	17-982	H-10824L	Hercules	18-969
H-10764L	Hercules	17-579	H-10825R	Hercules	18-968
H-10765R	Hercules	17-578	H-10826L	Hercules	18-971
H-10766L	Hercules	17-985	H-10827R	Hercules	18-970
H-10767R	Hercules	17-984	H-10828L	Hercules	18-981
H-10768L	Hercules	17-987	H-10829R	Hercules	18-980
H-10769L	Hercules	17-986	H-10830L	Hercules	18-963
H-10770L	Hercules	18-823	H-10831R	Hercules	18-962
H-10771R	Hercules	18-822	H-10832L	Hercules	18-973
H-10772L	Hercules	18-835	H-10833R	Hercules	18-972
H-10773R	Hercules	18-834	H-10834L	Hercules	18-975
H-107741	Hercules	18-781	H-10835R	Hercules	18-974
H-10775R	Hercules	18-780	H-10836L	Hercules	18-977
H-10776L	Hercules	18-713	H-10837R	Hercules	18-976
H-10777R	Hercules	18-712	H-10838L	Hercules	18-979

Manufacturer Number	Manufacturer	Spicer Number	Manufacturer Number	Manufacturer	Spicer Number
H-10839R	Hercules	18-978	H-10926L	Hercules	18-883
H-10844L	Hercules	18-937	H-10927R	Hercules	18-882
H-10845R	Hercules	18-936	H-10928L	Hercules	18-881
H-10846L	Hercules	18-939	H-10929R	Hercules	18-880
H-10847R	Hercules	18-938	H-10930L	Hercules	18-885
H-10854L	Hercules	17-657	H-10931R	Hercules	18-884
H-10855R	Hercules	17-656	H-10932L	Hercules	18-847
H-10856L	Hercules	17-659	H-10933R	Hercules	18-846
H-10857R	Hercules	17-658	H-10934L	Hercules	18-887
H-10858L	Hercules	17-661	H-10935R	Hercules	18-886
H-10859R	Hercules	17-660	H-8643	Hercules	43-7036A
H-10870L	Hercules	17-401	H-8643A	Hercules	43-7036A-1
H-10871R	Hercules	17-400	H-8644	Hercules	43-7044A
H-10872L	Hercules	17-405	H-8645	Hercules	43-7037
H-10873R	Hercules	17-404	H-8645A	Hercules	43-7037-1
H-10874L	Hercules	17-407	H-8646	Hercules	43-7047
H-10875R	Hercules	17-406	H-8648	Hercules	43-7041
H-10876L	Hercules	17-409	H-8648A	Hercules	43-7041-1
H-10877R	Hercules	17-408	H-8649	Hercules	43-7039
H-10878L	Hercules	17-403	H-8649A	Hercules	43-7039-1
H-10879R	Hercules	17-402	H-8650	Hercules	43-7038
H-10880L	Hercules	17-411	H-8650A	Hercules	43-7038-1
H-10881R	Hercules	17-410	H-8652	Hercules	43-7035
H-10882L	Hercules	17-415	H-8652A	Hercules	43-7035-1
H-10883R	Hercules	17-414	H-8655	Hercules	43-7033
H-10884L	Hercules	17-413	H-8655A	Hercules	43-7033-1
H-10885R	Hercules	17-412	H-8655Z	Hercules	43-7062
H-10886L	Hercules	17-417	H-8656	Hercules	43-7029
H-10887R	Hercules	17-416	H-8656A	Hercules	43-7029-1
H-10888L	Hercules	17-421	H-8657	Hercules	43-7042
H-10889R	Hercules	17-420	H-8660	Hercules	28-1255
H-10890L	Hercules	17-419	H-8661	Hercules	28-1243
H-10891R	Hercules	17-418	H-8681	Hercules	43-7044
H-10892L	Hercules	17-425	H-8682	Hercules	43-7031
H-10893R	Hercules	17-424	H-8682A	Hercules	43-7031-1
H-10918L	Hercules	18-841	H-8683	Hercules	43-7037A
H-10919R	Hercules	18-840	H-8683A	Hercules	43-7037A-1
H-10920L	Hercules	18-843	H-8684	Hercules	43-7043A
H-10921R	Hercules	18-842	H-86852	Hercules	43-7030
H-10922L	Hercules	18-845	H-8685ZA	Hercules	43-7030-1
H-10923R	Hercules	18-844	H-8686	Hercules	43-7046
H-10924L	Hercules	18-849	H-8688	Hercules	43-7050
H-10925R	Hercules	18-848	H-8696	Hercules	30-1358

CROSS REFERENCE

Manufacturer Number	Manufacturer	Spicer Number	Manufacturer Number	Manufacturer	Spicer Number
H-8707	Hercules	43-7048	HQ-10341R	Hercules	18-520
H-8712	Hercules	43-7040	HQ-10342L	Hercules	18-543
H-8712A	Hercules	43-7040-1	HQ-10343R	Hercules	18-542
H-8742	Hercules	43-7060	HQ-10344L	Hercules	18-503
H-8743	Hercules	43-7051	HQ-10345R	Hercules	18-502
H-8744	Hercules	43-7059	HQ-10346L	Hercules	18-507
H-8746	Hercules	43-7069	HQ-10347R	Hercules	18-506
H-8747	Hercules	43-7037B	HQ-10349R	Hercules	18-514
H-8747A	Hercules	43-7037B-1	HQ-10350L	Hercules	17-721
H-8766	Hercules	43-7048A	HQ-10351 R	Hercules	17-720
H-8772M	Hercules	43-7071	HQ-10352L	Hercules	17-723
H-8773M	Hercules	43-7072	HQ-10353R	Hercules	17-722
H-8788	Hercules	43-7072A	HQ-10354L	Hercules	17-725
H-8793	Hercules	43-7068	HQ-10355R	Hercules	17-724
H-8795	Hercules	43-7064	HQ-10356L	Hercules	18-525
H-8796	Hercules	43-7065	HQ-10357R	Hercules	18-524
HQ-10300L	Hercules	18-501	HQ-10358L	Hercules	18-527
HQ-10301R	Hercules	18-500	HQ-10359R	Hercules	18-526
HQ-10302L	Hercules	18-505	HQ-10360L	Hercules	18-509
HQ-10303R	Hercules	18-504	HQ-10361R	Hercules	18-508
HQ-10304L	Hercules	18-931	HQ-10362L	Hercules	18-523
HQ-10305R	Hercules	18-930	HQ-10363R	Hercules	18-522
HQ-10306L	Hercules	18-511	HQ-10364L	Hercules	17-811
HQ-10307R	Hercules	18-510	HQ-10365R	Hercules	17-810
HQ-10308L	Hercules	18-513	HQ-10366L	Hercules	17-813
HQ-10309R	Hercules	18-512	HQ-10367R	Hercules	17-812
HQ-10310L	Hercules	18-517	HQ-10368L	Hercules	17-815
HQ-10311R	Hercules	18-516	HQ-10369R	Hercules	17-814
HQ-10312L	Hercules	18-519	K123	Leland	43-7032
HQ-10313R	Hercules	18-518	K123(2)	Leland	43-7032
HQ-10316L	Hercules	18-529	K131	Leland	43-7053A
HQ-10317R	Hercules	18-528	K138	Leland	43-7042
HQ-10318L	Hercules	18-531	K139(2)	Leland	43-7042
HQ-10319R	Hercules	18-530	K140(2)	Leland	43-7041
HQ-10322L	Hercules	18-535	K141	Leland	43-7043A
HQ-10323R	Hercules	18-534	K144	Leland	43-7031
HQ-10324R	Hercules	18-539	K144(2)	Leland	43-7031
HQ-10325R	Hercules	18-538	K145	Leland	43-7062
HQ-10328L	Hercules	18-541	K145(2)	Leland	43-7033
HQ-10329R	Hercules	18-540	K146	Leland	43-7029
HQ-10336L	Hercules	18-537	K147(2)	Leland	43-7040
HQ-10337R	Hercules	18-536	K149	Leland	43-7044A
HQ-10340L	Hercules	18-521	K152(2)	Leland	43-7046

CROSS REFERENCE

Manufacturer Number	Manufacturer	Spicer Number	Manufacturer Number	Manufacturer	Spicer Number
K264	Leland	43-7060	KIT 9300	Meritor / Rockwell	43-7051
K264(2)	Leland	43-7060	KIT 9304	Meritor / Rockwell	43-7050
K268	Leland	43-7044	KIT 969	Meritor / Rockwell	43-7044A
K268(2)	Leland	43-7044	KIT 970	Meritor / Rockwell	43-7037
K270	Leland	43-7037A	KIT 971	Meritor / Rockwell	43-7046
K272	Leland	43-7050	KIT 971	Meritor / Rockwell	43-7046A
K272(2)	Leland	43-7050	L-1023	Leland	17-622
K273	Leland	43-7051	L-1024	Leland	17-623
K273(2)	Leland	43-7051	L-1072	Leland	18-784
K278	Leland	43-7048	L-1073	Leland	18-785
K278(2)	Leland	43-7048	L-1074	Leland	17-684
K285	Leland	43-7059	L-1075	Leland	17-685
K289	Leland	43-7071	L-1193	Leland	17-566
K312	Leland	43-7068	L-1194	Leland	17-567
K313	Leland	43-7072	L-1202	Leland	18-738
K48	Leland	43-7034	L-1203	Leland	18-739
K52	Leland	43-7038	L-1204	Leland	18-808
K52(2)	Leland	43-7038	L-1205	Leland	18-809
K80	Leland	43-7041	L-1298	Leland	17-626
K81	Leland	43-7047	L-1298	Leland	17-720
K82	Leland	43-7044	L-1298	Leland	17-810
K84	Leland	43-7032	L-1299	Leland	17-627
K86	Leland	43-7042	L-1299	Leland	17-721
K88	Leland	43-7039	L-1299	Leland	17-811
K91	Leland	43-7040	L-1384	Leland	17-698
K95	Leland	43-7046	L-1385	Leland	17-699
K97	Leland	43-7037	L-1412	Leland	18-804
K98	Leland	43-7046A	L-1413	Leland	18-805
K99	Leland	43-7030	L-1476	Leland	17-628
KIT 8022	Meritor / Rockwell	43-7059	L-1476	Leland	17-722
KIT 8032	Meritor / Rockwell	43-7100	L-1476	Leland	17-812
KIT 8033	Meritor / Rockwell	43-7101	L-1477	Leland	17-629
KIT 8042	Meritor / Rockwell	43-7047	L-1477	Leland	17-723
KIT 8046	Meritor / Rockwell	43-7044	L-1477	Leland	17-813
KIT 8047	Meritor / Rockwell	43-7046	L-1617	Leland	17-634
KIT 8048	Meritor / Rockwell	43-7037A	L-1618	Leland	17-635
KIT 8058	Meritor / Rockwell	43-7071	L-1619	Leland	18-740
KIT 8289	Meritor / Rockwell	43-7072A	L-1620	Leland	18-741
KIT 847	Meritor / Rockwell	43-7046	L-1628	Leland	17-11072
KIT 8821	Meritor / Rockwell	43-7048A	L-1629	Leland	17-11071
KIT 9035	Meritor / Rockwell	43-7046A	L-1631	Leland	18-726
KIT 9036	Meritor / Rockwell	43-7110	L-1632	Leland	18-727
KIT 9078	Meritor / Rockwell	43-7034	L-1651	Leland	17-640

CROSS REFERENCE

Manufacturer Number	Manufacturer	Spicer Number	Manufacturer Number	Manufacturer	Spicer Number
L-1652	Leland	17-641	L-234	Leland	17-576
L-1653	Leland	17-642	L-2340	Leland	18-516
L-1654	Leland	17-643	L-2340	Leland	18-830
L-1655	Leland	17-632	L-2341	Leland	18-517
L-1656	Leland	17-633	L-2341	Leland	18-831
L-1657	Leland	17-630	L-2342	Leland	18-534
L-1657	Leland	17-724	L-2342	Leland	18-834
L-1657	Leland	17-814	L-2343	Leland	18-535
L-1658	Leland	17-631	L-2343	Leland	18-835
L-1658	Leland	17-725	L-2347	Leland	17-700
L-1658	Leland	17-815	L-2348	Leland	17-701
L-1678	Leland	18-910	L-235	Leland	17-577
L-1679	Leland	18-911	L-2356	Leland	17-584
L-1684	Leland	18-852	L-2357	Leland	17-585
L-1685	Leland	18-853	L-2379	Leland	17-618
L-1698	Leland	17-624	L-2380	Leland	17-619
L-1699	Leland	17-625	L-2401	Leland	18-816
L-1720	Leland	18-848	L-2402	Leland	18-817
L-1721	Leland	18-849	L-2403	Leland	18-854
L-1722	Leland	18-886	L-2404	Leland	18-855
L-1723	Leland	18-887	L-2438	Leland	17-572
L-173	Leland	17-580	L-2439	Leland	17-573
L-1737	Leland	18-856	L-2440	Leland	17-568
L-1737	Leland	18-950	L-2441	Leland	17-569
L-1738	Leland	18-857	L-2442	Leland	17-560
L-1738	Leland	18-951	L-2443	Leland	17-561
L-1739	Leland	18-872	L-2446	Leland	18-790
L-1739	Leland	18-956	L-2447	Leland	18-791
L-174	Leland	17-581	L-2448	Leland	18-528
L-1740	Leland	18-873	L-2448	Leland	18-724
L-1740	Leland	18-957	L-2449	Leland	18-725
L-2089	Leland	17-588	L-2450	Leland	18-812
L-2090	Leland	17-589	L-2451	Leland	18-813
L-224	Leland	17-582	L-2452	Leland	18-786
L-225	Leland	17-583	L-2453	Leland	18-787
L-228	Leland	18-742	L-2454	Leland	18-806
L-229	Leland	18-743	L-2455	Leland	18-807
L-232	Leland	18-840	L-2456	Leland	18-802
L-233	Leland	18-841	L-2457	Leland	18-803
L-2338	Leland	18-518	L-2458	Leland	18-800
L-2338	Leland	18-832	L-2459	Leland	18-801
L-2339	Leland	18-519	L-2460	Leland	18-846
L-2339	Leland	18-833	L-2461	Leland	18-847

CROSS REFERENCE

Manufacturer Number	Manufacturer	Spicer Number	Manufacturer Number	Manufacturer	Spicer Number
L-2462	Leland	18-844	L-2871	Leland	18-825
L-2463	Leland	18-845	L-2872	Leland	18-510
L-2464	Leland	18-880	L-2872	Leland	18-826
L-2465	Leland	18-881	L-2873	Leland	18-511
L-2466	Leland	17-636	L-2873	Leland	18-827
L-2467	Leland	17-637	L-2874	Leland	18-508
L-2468	Leland	17-676	L-2874	Leland	18-864
L-2469	Leland	17-677	L-2875	Leland	18-509
L-2470	Leland	17-680	L-2875	Leland	18-865
L-2471	Leland	17-681	L-2876	Leland	18-514
L-2472	Leland	17-692	L-2876	Leland	18-828
L-2473	Leland	17-693	L-2877	Leland	18-515
L-2476	Leland	17-696	L-2877	Leland	18-829
L-2476	Leland	17-708	L-2878	Leland	18-516
L-2477	Leland	17-697	L-2879	Leland	18-517
L-2477	Leland	17-709	L-2880	Leland	18-524
L-2480	Leland	18-746	L-2880	Leland	18-868
L-2481	Leland	18-747	L-2881	Leland	18-525
L-2482	Leland	18-748	L-2881	Leland	18-869
L-2483	Leland	18-749	L-2882	Leland	18-836
L-2484	Leland	18-736	L-2883	Leland	18-837
L-2485	Leland	18-737	L-2884	Leland	18-820
L-2486	Leland	18-734	L-2885	Leland	18-529
L-2487	Leland	18-735	L-2885	Leland	18-821
L-2488	Leland	18-732	L-2886	Leland	18-530
L-2489	Leland	18-733	L-2887	Leland	18-531
L-261	Leland	17-578	L-2888	Leland	18-532
L-262	Leland	17-579	L-2888	Leland	18-822
L-2796	Leland	17-590	L-2889	Leland	18-533
L-2797	Leland	17-591	L-2889	Leland	18-823
L-2834	Leland	18-762	L-2890	Leland	18-780
L-2835	Leland	18-763	L-2891	Leland	18-781
L-2836	Leland	18-774	L-2897	Leland	17-500
L-2837	Leland	18-775	L-2898	Leland	17-501
L-2838	Leland	18-772	L-2902	Leland	17-750
L-2839	Leland	18-773	L-2903	Leland	17-751
L-2868	Leland	18-502	L-2904	Leland	17-756
L-2868	Leland	18-860	L-2905	Leland	17-757
L-2869	Leland	18-503	L-2908	Leland	17-760
L-2869	Leland	18-861	L-2909	Leland	17-761
L-2870	Leland	18-504	L-291	Leland	18-728
L-2870	Leland	18-824	L-2910	Leland	17-764
L-2871	Leland	18-505	L-2911	Leland	17-765

CROSS REFERENCE

Manufacturer Number	Manufacturer	Spicer Number	Manufacturer Number	Manufacturer	Spicer Number
L-2912	Leland	17-770	L-3094	Leland	18-512
L-2913	Leland	17-771	L-3095	Leland	18-513
L-2914	Leland	17-660	L-3096	Leland	18-516
L-2914	Leland	17-754	L-3097	Leland	18-517
L-2915	Leland	17-661	L-3098	Leland	18-518
L-2915	Leland	17-755	L-3099	Leland	18-519
L-2919	Leland	17-744	L-3100	Leland	18-528
L-292	Leland	18-729	L-3101	Leland	18-529
L-2920	Leland	17-745	L-3102	Leland	18-530
L-2948	Leland	17-594	L-3103	Leland	18-531
L-2949	Leland	17-595	L-3104	Leland	18-532
L-2966	Leland	17-460	L-3105	Leland	18-533
L-2967	Leland	17-461	L-3106	Leland	18-534
L-2968	Leland	17-462	L-3107	Leland	18-535
L-2969	Leland	17-463	L-3108	Leland	18-538
L-2970	Leland	18-940	L-3109	Leland	18-539
L-2971	Leland	18-941	L-3110	Leland	18-540
L-2974	Leland	18-942	L-3111	Leland	18-541
L-2975	Leland	18-943	L-3112	Leland	17-720
L-2976	Leland	18-984	L-3113	Leland	17-721
L-2977	Leland	18-985	L-3114	Leland	17-722
L-3030	Leland	17-512	L-3115	Leland	17-723
L-3031	Leland	17-513	L-3116	Leland	17-724
L-3044	Leland	17-502	L-3117	Leland	17-725
L-3045	Leland	17-503	L-3130	Leland	17-738
L-3046	Leland	17-510	L-3131	Leland	17-739
L-3047	Leland	17-511	L-3132	Leland	17-754
L-3072	Leland	17-500	L-3133	Leland	17-755
L-3073	Leland	17-501	L-3134	Leland	17-764
L-3076	Leland	18-982	L-3135	Leland	17-765
L-3077	Leland	18-983	L-3136	Leland	17-750
L-3080	Leland	18-890	L-3137	Leland	17-751
L-3081	Leland	18-891	L-3138	Leland	17-756
L-3082	Leland	18-892	L-3139	Leland	17-757
L-3083	Leland	18-893	L-3140	Leland	17-744
L-3084	Leland	18-896	L-3141	Leland	17-745
L-3085	Leland	18-897	L-3142	Leland	17-770
L-3086	Leland	18-906	L-3143	Leland	17-771
L-3087	Leland	18-907	L-3170	Leland	17-782
L-3090	Leland	18-930	L-3171	Leland	17-783
L-3091	Leland	18-931	L-3186	Leland	18-704
L-3092	Leland	18-510	L-3187	Leland	18-705
L-3093	Leland	18-511	L-3188	Leland	18-708

CROSS REFERENCE

Manufacturer Number	Manufacturer	Spicer Number	Manufacturer Number	Manufacturer	Spicer Number
L-3189	Leland	18-709	L-914	Leland	17-594
L-3258	Leland	17-798	L-915	Leland	17-595
L-3259	Leland	17-799	M1015L	BWP	17-569
L-3260	Leland	17-786	M1015R	BWP	17-568
L-3261	Leland	17-787	M10KY100	Spicer OE	43-7030
L-3262	Leland	17-972	M10KY105	Spicer OE	43-7118
L-3263	Leland	17-973	M10KY106	Spicer OE	43-7117
L-3264	Leland	17-796	M12KY100	Spicer OE	43-7030
L-3265	Leland	17-797	M12KY101	Spicer OE	43-7033
L-3266	Leland	17-976	M12KY201	Spicer OE	43-7031
L-3267	Leland	17-977	M12KY202	Spicer OE	43-7033
L-3268	Leland	17-402	M12WK100-11	Spicer OE	17-676
L-3269	Leland	17-403	M12WK100-16	Spicer OE	17-692
L-3270	Leland	17-996	M12WK100-17	Spicer OE	17-690
L-3271	Leland	17-997	M12WK100-18	Spicer OE	17-710
L-3272	Leland	17-414	M12WK100-19	Spicer OE	17-694
L-3273	Leland	17-415	M12WK100-22	Spicer OE	17-696
L-3274	Leland	17-418	M12WK101-11	Spicer OE	17-677
L-3275	Leland	17-419	M12WK101-16	Spicer OE	17-693
L-3276	Leland	17-416	M12WK101-17	Spicer OE	17-691
L-3277	Leland	17-417	M12WK101-18	Spicer OE	17-711
L-3302	Leland	17-734	M12WK101-19	Spicer OE	17-695
L-3303	Leland	17-735	M12WK101-22	Spicer OE	17-697
L-3304	Leland	17-762	M12WK106-1	Spicer OE	17-676
L-3305	Leland	17-763	M12WK106-10	Spicer OE	17-690
L-386	Leland	17-598	M12WK106-11	Spicer OE	17-694
L-387	Leland	17-599	M12WK106-13	Spicer OE	17-696
L-446	Leland	18-730	M12WK106-3	Spicer OE	17-680
L-447	Leland	18-731	M12WK106-6	Spicer OE	17-684
L-507	Leland	18-810	M12WK106-7	Spicer OE	17-692
L-508	Leland	18-811	M12WK107-1	Spicer OE	17-677
L-580	Leland	17-575	M12WK107-10	Spicer OE	17-691
L-581	Leland	17-574	M12WK107-11	Spicer OE	17-695
L-733	Leland	17-690	M12WK107-13	Spicer OE	17-697
L-734	Leland	17-691	M12WK107-3	Spicer OE	17-681
L-735	Leland	17-694	M12WK107-6	Spicer OE	17-685
L-736	Leland	17-695	M12WK107-7	Spicer OE	17-693
L-838	Leland	17-621	M12WKL10-163	Spicer OE	17-735
L-839	Leland	17-620	M12WKL10-175	Spicer OE	17-737
L-900	Leland	17-683	M12WKL10-182	Spicer OE	17-679
L-901	Leland	17-682	M12WKL10-182	Spicer OE	17-741
L-902	Leland	17-586	M12WKL10-191	Spicer OE	17-677
L-903	Leland	17-587	M12WKL10-191	Spicer OE	17-745

CROSS REFERENCE

Manufacturer Number	Manufacturer	Spicer Number	Manufacturer Number	Manufacturer	Spicer Number
M12WKL10-202	Spicer OE	17-689	M12WKL15-254	Spicer OE	17-991
M12WKL10-202	Spicer OE	17-747	M12WKL15-264	Spicer OE	17-993
M12WKL10-204	Spicer OE	17-749	M12WKL15-266	Spicer OE	17-995
M12WKL10-205	Spicer OE	17-681	M12WKL20-163	Spicer OE	17-785
M12WKL10-206	Spicer OE	17-751	M12WKL20-182	Spicer OE	17-789
M12WKL10-213	Spicer OE	17-685	M12WKL20-191	Spicer OE	17-793
M12WKL10-213	Spicer OE	17-753	M12WKL20-205	Spicer OE	17-795
M12WKL10-214	Spicer OE	17-687	M12WKL20-213	Spicer OE	17-439
M12WKL10-214	Spicer OE	17-755	M12WKL20-213	Spicer OE	17-781
M12WKL10-222	Spicer OE	17-693	M12WKL20-214	Spicer OE	17-787
M12WKL10-222	Spicer OE	17-757	M12WKL20-222	Spicer OE	17-797
M12WKL10-225	Spicer OE	17-759	M12WKL20-233	Spicer OE	17-443
M12WKL10-233	Spicer OE	17-739	M12WKL20-233	Spicer OE	17-783
M12WKL10-234	Spicer OE	17-691	M12WKL20-234	Spicer OE	17-779
M12WKL10-234	Spicer OE	17-761	M12WKL20-241	Spicer OE	17-799
M12WKL10-236	Spicer OE	17-711	M12WKL20-264	Spicer OE	17-805
M12WKL10-236	Spicer OE	17-763	M12WKL25-163	Spicer OE	17-401
M12WKL10-241	Spicer OE	17-695	M12WKL25-182	Spicer OE	17-405
M12WKL10-241	Spicer OE	17-765	M12WKL25-191	Spicer OE	17-407
M12WKL10-247	Spicer OE	17-649	M12WKL25-205	Spicer OE	17-409
M12WKL10-247	Spicer OE	17-767	M12WKL25-206	Spicer OE	17-403
M12WKL10-253	Spicer OE	17-707	M12WKL25-213	Spicer OE	17-411
M12WKL10-254	Spicer OE	17-769	M12WKL25-214	Spicer OE	17-415
M12WKL10-264	Spicer OE	17-709	M12WKL25-222	Spicer OE	17-413
M12WKL10-264	Spicer OE	17-771	M12WKL25-233	Spicer OE	17-417
M12WKL10-266	Spicer OE	17-697	M12WKL25-234	Spicer OE	17-421
M12WKL10-266	Spicer OE	17-773	M12WKL25-241	Spicer OE	17-419
M12WKL15-163	Spicer OE	17-961	M12WKL25-264	Spicer OE	17-425
M12WKL15-175	Spicer OE	17-963	M12WKR10-163	Spicer OE	17-734
M12WKL15-182	Spicer OE	17-965	M12WKR10-175	Spicer OE	17-736
M12WKL15-191	Spicer OE	17-967	M12WKR10-182	Spicer OE	17-678
M12WKL15-202	Spicer OE	17-969	M12WKR10-182	Spicer OE	17-740
M12WKL15-204	Spicer OE	17-971	M12WKR10-191	Spicer OE	17-676
M12WKL15-206	Spicer OE	17-973	M12WKR10-191	Spicer OE	17-744
M12WKL15-213	Spicer OE	17-975	M12WKR10-202	Spicer OE	17-688
M12WKL15-214	Spicer OE	17-977	M12WKR10-202	Spicer OE	17-746
M12WKL15-222	Spicer OE	17-979	M12WKR10-204	Spicer OE	17-748
M12WKL15-225	Spicer OE	17-981	M12WKR10-205	Spicer OE	17-680
M12WKL15-233	Spicer OE	17-997	M12WKR10-206	Spicer OE	17-750
M12WKL15-234	Spicer OE	17-983	M12WKR10-213	Spicer OE	17-684
M12WKL15-236	Spicer OE	17-985	M12WKR10-213	Spicer OE	17-752
M12WKL15-241	Spicer OE	17-987	M12WKR10-214	Spicer OE	17-686
M12WKL15-247	Spicer OE	17-989	M12WKR10-214	Spicer OE	17-754

Manufacturer Number	Manufacturer	Spicer Number	Manufacturer Number	Manufacturer	Spicer Number
M12WKR10-222	Spicer OE	17-692	M12WKR20-214	Spicer OE	17-786
M12WKR10-222	Spicer OE	17-756	M12WKR20-222	Spicer OE	17-796
M12WKR10-225	Spicer OE	17-758	M12WKR20-233	Spicer OE	17-442
M12WKR10-233	Spicer OE	17-738	M12WKR20-233	Spicer OE	17-782
M12WKR10-234	Spicer OE	17-690	M12WKR20-234	Spicer OE	17-778
M12WKR10-234	Spicer OE	17-760	M12WKR20-241	Spicer OE	17-798
M12WKR10-236	Spicer OE	17-710	M12WKR20-264	Spicer OE	17-804
M12WKR10-236	Spicer OE	17-762	M12WKR25-163	Spicer OE	17-400
M12WKR10-241	Spicer OE	17-694	M12WKR25-182	Spicer OE	17-404
M12WKR10-241	Spicer OE	17-764	M12WKR25-191	Spicer OE	17-406
M12WKR10-247	Spicer OE	17-648	M12WKR25-205	Spicer OE	17-408
M12WKR10-247	Spicer OE	17-766	M12WKR25-206	Spicer OE	17-402
M12WKR10-253	Spicer OE	17-706	M12WKR25-213	Spicer OE	17-410
M12WKR10-254	Spicer OE	17-768	M12WKR25-214	Spicer OE	17-414
M12WKR10-264	Spicer OE	17-708	M12WKR25-222	Spicer OE	17-412
M12WKR10-264	Spicer OE	17-770	M12WKR25-233	Spicer OE	17-416
M12WKR10-266	Spicer OE	17-696	M12WKR25-234	Spicer OE	17-420
M12WKR10-266	Spicer OE	17-772	M12WKR25-241	Spicer OE	17-418
M12WKR15-163	Spicer OE	17-960	M12WKR25-264	Spicer OE	17-424
M12WKR15-175	Spicer OE	17-962	M16KY20	Spicer OE	43-7032
M12WKR15-182	Spicer OE	17-964	M16KY201	Spicer OE	43-7030
M12WKR15-191	Spicer OE	17-966	M16KY202	Spicer OE	43-7033
M12WKR15-202	Spicer OE	17-968	M16WK102-10	Spicer OE	17-569
M12WKR15-204	Spicer OE	17-970	M16WK102-12	Spicer OE	17-566
M12WKR15-206	Spicer OE	17-972	M16WK102-13	Spicer OE	17-579
M12WKR15-213	Spicer OE	17-974	M16WK102-17	Spicer OE	17-581
M12WKR15-214	Spicer OE	17-976	M16WK102-19	Spicer OE	17-583
M12WKR15-222	Spicer OE	17-978	M16WK102-23	Spicer OE	17-519
M12WKR15-225	Spicer OE	17-980	M16WK102-25	Spicer OE	17-575
M12WKR15-233	Spicer OE	17-996	M16WK102-26	Spicer OE	17-587
M12WKR15-234	Spicer OE	17-982	M16WK102-5	Spicer OE	17-561
M12WKR15-236	Spicer OE	17-984	M16WK102-7	Spicer OE	17-571
M12WKR15-241	Spicer OE	17-986	M16WK102-76	Spicer OE	17-585
M12WKR15-247	Spicer OE	17-988	M16WK102-83	Spicer OE	17-589
M12WKR15-254	Spicer OE	17-990	M16WK102-9	Spicer OE	17-576
M12WKR15-264	Spicer OE	17-992	M16WK103-10	Spicer OE	17-568
M12WKR15-266	Spicer OE	17-994	M16WK103-12	Spicer OE	17-567
M12WKR20-163	Spicer OE	17-784	M16WK103-13	Spicer OE	17-578
M12WKR20-182	Spicer OE	17-788	M16WK103-17	Spicer OE	17-580
M12WKR20-191	Spicer OE	17-792	M16WK103-19	Spicer OE	17-582
M12WKR20-205	Spicer OE	17-794	M16WK103-23	Spicer OE	17-518
M12WKR20-213	Spicer OE	17-438	M16WK103-25	Spicer OE	17-574
M12WKR20-213	Spicer OE	17-780	M16WK103-26	Spicer OE	17-586

CROSS REFERENCE

Manufacturer Number	Manufacturer	Spicer Number	Manufacturer Number	Manufacturer	Spicer Number
M16WK103-5	Spicer OE	17-560	M16WKL10-260	Spicer OE	17-539
M16WK103-7	Spicer OE	17-570	M16WKL10-260	Spicer OE	17-597
M16WK103-76	Spicer OE	17-584	M16WKL10-264	Spicer OE	17-557
M16WK103-83	Spicer OE	17-588	M16WKL10-264	Spicer OE	17-591
M16WK103-9	Spicer OE	17-577	M16WKL10-266	Spicer OE	17-559
M16WK104-10	Spicer OE	17-479	M16WKL10-266	Spicer OE	17-593
M16WK104-17	Spicer OE	17-481	M16WKL10-304	Spicer OE	17-565
M16WK104-23	Spicer OE	17-485	M16WKL15-164	Spicer OE	17-841
M16WK104-25	Spicer OE	17-483	M16WKL15-166	Spicer OE	17-843
M16WK105-10	Spicer OE	17-478	M16WKL15-175	Spicer OE	17-845
M16WK105-17	Spicer OE	17-480	M16WKL15-180	Spicer OE	17-847
M16WK105-23	Spicer OE	17-484	M16WKL15-185	Spicer OE	17-849
M16WK105-25	Spicer OE	17-482	M16WKL15-187	Spicer OE	17-851
M16WK110-12	Spicer OE	17-588	M16WKL15-205	Spicer OE	17-853
M16WK110-4	Spicer OE	17-578	M16WKL15-213	Spicer OE	17-855
M16WK111-12	Spicer OE	17-589	M16WKL15-222	Spicer OE	17-857
M16WK111-4	Spicer OE	17-579	M16WKL15-227	Spicer OE	17-859
M16WK116	Spicer OE	17-568	M16WKL15-231	Spicer OE	17-861
M16WK117	Spicer OE	17-569	M16WKL15-236	Spicer OE	17-863
M16WKL10-073	Spicer OE	17-609	M16WKL15-242	Spicer OE	17-865
M16WKL10-164	Spicer OE	17-541	M16WKL15-245	Spicer OE	17-867
M16WKL10-165	Spicer OE	17-571	M16WKL15-260	Spicer OE	17-869
M16WKL10-166	Spicer OE	17-543	M16WKL15-264	Spicer OE	17-871
M16WKL10-166	Spicer OE	17-577	M16WKL15-266	Spicer OE	17-873
M16WKL10-175	Spicer OE	17-517	M16WKL15-304	Spicer OE	17-881
M16WKL10-180	Spicer OE	17-545	M16WKL20-147	Spicer OE	18-781
M16WKL10-185	Spicer OE	17-547	M16WKL20-166	Spicer OE	17-521
M16WKL10-187	Spicer OE	17-549	M16WKL20-173	Spicer OE	17-531
M16WKL10-196	Spicer OE	17-537	M16WKL20-175	Spicer OE	17-513
M16WKL10-205	Spicer OE	17-505	M16WKL20-205	Spicer OE	17-501
M16WKL10-213	Spicer OE	17-551	M16WKL20-227	Spicer OE	17-525
M16WKL10-213	Spicer OE	17-583	M16WKL20-231	Spicer OE	17-511
M16WKL10-222	Spicer OE	17-563	M16WKL20-236	Spicer OE	17-503
M16WKL10-223	Spicer OE	17-599	M16WKL20-241	Spicer OE	17-491
M16WKL10-227	Spicer OE	17-553	M16WKL20-242	Spicer OE	17-515
M16WKL10-231	Spicer OE	17-519	M16WKL20-262	Spicer OE	17-493
M16WKL10-231	Spicer OE	17-595	M16WKL20-264	Spicer OE	17-527
M16WKL10-236	Spicer OE	17-509	M16WKL20-271	Spicer OE	17-523
M16WKL10-242	Spicer OE	17-507	M16WKL20-304	Spicer OE	17-529
M16WKL10-242	Spicer OE	17-587	M16WKL25-166	Spicer OE	17-913
M16WKL10-245	Spicer OE	17-555	M16WKL25-175	Spicer OE	17-915
M16WKL10-245	Spicer OE	17-589	M16WKL25-205	Spicer OE	17-921
M16WKL10-250	Spicer OE	17-535	M16WKL25-215	Spicer OE	17-923

Manufacturer Number	Manufacturer	Spicer Number	Manufacturer Number	Manufacturer	Spicer Number
M16WKL25-225	Spicer OE	17-933	M16WKR15-185	Spicer OE	17-848
M16WKL25-227	Spicer OE	17-925	M16WKR15-187	Spicer OE	17-850
M16WKL25-231	Spicer OE	17-927	M16WKR15-205	Spicer OE	17-852
M16WKL25-236	Spicer OE	17-929	M16WKR15-213	Spicer OE	17-854
M16WKL25-242	Spicer OE	17-931	M16WKR15-222	Spicer OE	17-856
M16WKL25-264	Spicer OE	17-937	M16WKR15-227	Spicer OE	17-858
M16WKL25-271	Spicer OE	17-941	M16WKR15-231	Spicer OE	17-860
M16WKL25-304	Spicer OE	17-947	M16WKR15-236	Spicer OE	17-862
M16WKR10-073	Spicer OE	17-608	M16WKR15-242	Spicer OE	17-864
M16WKR10-164	Spicer OE	17-540	M16WKR15-245	Spicer OE	17-866
M16WKR10-165	Spicer OE	17-570	M16WKR15-260	Spicer OE	17-868
M16WKR10-166	Spicer OE	17-542	M16WKR15-264	Spicer OE	17-870
M16WKR10-166	Spicer OE	17-576	M16WKR15-266	Spicer OE	17-872
M16WKR10-175	Spicer OE	17-516	M16WKR15-304	Spicer OE	17-880
M16WKR10-180	Spicer OE	17-544	M16WKR20-147	Spicer OE	18-780
M16WKR10-185	Spicer OE	17-546	M16WKR20-166	Spicer OE	17-520
M16WKR10-187	Spicer OE	17-548	M16WKR20-173	Spicer OE	17-530
M16WKR10-196	Spicer OE	17-536	M16WKR20-175	Spicer OE	17-512
M16WKR10-205	Spicer OE	17-504	M16WKR20-205	Spicer OE	17-500
M16WKR10-213	Spicer OE	17-550	M16WKR20-227	Spicer OE	17-524
M16WKR10-213	Spicer OE	17-582	M16WKR20-231	Spicer OE	17-510
M16WKR10-222	Spicer OE	17-562	M16WKR20-236	Spicer OE	17-502
M16WKR10-223	Spicer OE	17-598	M16WKR20-241	Spicer OE	17-490
M16WKR10-227	Spicer OE	17-552	M16WKR20-242	Spicer OE	17-514
M16WKR10-231	Spicer OE	17-518	M16WKR20-262	Spicer OE	17-492
M16WKR10-231	Spicer OE	17-594	M16WKR20-264	Spicer OE	17-526
M16WKR10-236	Spicer OE	17-508	M16WKR20-271	Spicer OE	17-522
M16WKR10-242	Spicer OE	17-506	M16WKR20-304	Spicer OE	17-528
M16WKR10-242	Spicer OE	17-586	M16WKR25-166	Spicer OE	17-912
M16WKR10-245	Spicer OE	17-554	M16WKR25-175	Spicer OE	17-914
M16WKR10-245	Spicer OE	17-588	M16WKR25-205	Spicer OE	17-920
M16WKR10-250	Spicer OE	17-534	M16WKR25-215	Spicer OE	17-922
M16WKR10-260	Spicer OE	17-538	M16WKR25-225	Spicer OE	17-932
M16WKR10-260	Spicer OE	17-596	M16WKR25-227	Spicer OE	17-924
M16WKR10-264	Spicer OE	17-556	M16WKR25-231	Spicer OE	17-926
M16WKR10-264	Spicer OE	17-590	M16WKR25-236	Spicer OE	17-928
M16WKR10-266	Spicer OE	17-558	M16WKR25-242	Spicer OE	17-930
M16WKR10-266	Spicer OE	17-592	M16WKR25-264	Spicer OE	17-936
M16WKR10-304	Spicer OE	17-564	M16WKR25-271	Spicer OE	17-940
M16WKR15-164	Spicer OE	17-840	M16WKR25-304	Spicer OE	17-946
M16WKR15-166	Spicer OE	17-842	M20WK102-1	Spicer OE	17-670
M16WKR15-175	Spicer OE	17-844	M20WK102-3	Spicer OE	17-672
M16WKR15-180	Spicer OE	17-846	M20WK103-1	Spicer OE	17-671

CROSS REFERENCE

Manufacturer Number	Manufacturer	Spicer Number	Manufacturer Number	Manufacturer	Spicer Number
M20WK103-3	Spicer OE	17-673	M-1569L	BWP	18-843
MK14	BWP	43-7044	M-1569R	BWP	18-842
MK15	BWP	43-7044A	M-1570L	BWP	18-819
MK16	BWP	43-7037	M-1570R	BWP	18-818
MK17	BWP	43-7034	M-1571L	BWP	18-739
MK18	BWP	43-7042	M-1571R	BWP	18-738
MK19	BWP	43-7041	M-2017L	BWP	17-589
MK20	BWP	43-7039	M-2017R	BWP	17-588
MK21	BWP	43-7038	M-2020L	BWP	17-617
MK23	BWP	43-7032	M-2020R	BWP	17-616
MK25	BWP	43-7031	M-2024L	BWP	18-807
MK26	BWP	43-7062	M-2024R	BWP	18-806
MK27	BWP	43-7029	M-2025L	BWP	17-701
MK60	BWP	43-7040	M-2025R	BWP	17-700
MK61	BWP	43-7037A	M-2026L	BWP	18-825
MK63	BWP	43-7043A	M-2026R	BWP	18-824
MK64	BWP	43-7030	M-2027L	BWP	18-829
MK65	BWP	43-7046A	M-2027R	BWP	18-828
MK66	BWP	43-7053A	M-2030L	BWP	18-837
MK68	BWP	43-7051	M-2030R	BWP	18-836
MK69	BWP	43-7050	M-2031L	BWP	18-821
M-15026	BWP	43-7034	M-2031R	BWP	18-820
M-15026A	BWP	43-7048	M-2032L	BWP	18-823
M-15027	BWP	43-7044A	M-2032R	BWP	18-822
M-15028	BWP	43-7037A	M-2033L	BWP	18-835
M-15032	BWP	43-7044	M-2033R	BWP	18-834
M-15034	BWP	43-7032	M-2085	BWP	43-7032
M-15036	BWP	43-7038	M-2086	BWP	43-7032A
M-15038	BWP	43-7041	M-2088	BWP	43-7042
M-15039	BWP	43-7039	M-2089	BWP	43-7046A
M-15040	BWP	43-7037	M-2090	BWP	43-7043A
M-15390	BWP	18-830	M-2091	BWP	43-7033
M-15391	BWP	18-831	M-2093	BWP	43-7040
M-15392	BWP	18-832	M-2095	BWP	43-7050
M-15393	BWP	18-833	M-2096	BWP	43-7051
M-1563L	BWP	18-743	M-2097	BWP	43-7060
M-1563R	BWP	18-742	M-2098	BWP	43-7053A
M-1564L	BWP	18-731	M-2597L	BWP	18-529
M-1564R	BWP	18-730	M-2597L	BWP	18-821
M-1566L	BWP	18-729	M-2597R	BWP	18-528
M-1566R	BWP	18-728	M-2597R	BWP	18-820
M-1567L	BWP	18-841	M-2598L	BWP	18-531
M-1567R	BWP	18-840	M-2598L	BWP	18-533

Manufacturer Number	Manufacturer	Spicer Number	Manufacturer Number	Manufacturer	Spicer Number
M-2598L	BWP	18-823	M-2614L	BWP	18-833
M-2598R	BWP	18-530	M-2614R	BWP	18-518
M-2598R	BWP	18-532	M-2614R	BWP	18-832
M-2598R	BWP	18-822	M-2615L	BWP	18-727
M-2599L	BWP	18-535	M-2615R	BWP	18-726
M-2599L	BWP	18-835	M-2616L	BWP	18-741
M-2599R	BWP	18-534	M-2616R	BWP	18-740
M-2599R	BWP	18-834	M-2617L	BWP	18-747
M-2600L	BWP	17-635	M-2617R	BWP	18-746
M-2600R	BWP	17-634	M-3178L	BWP	17-579
M-2601L	BWP	17-589	M-3178R	BWP	17-578
M-2601R	BWP	17-588	M-3179L	BWP	18-511
M-2602L	BWP	17-701	M-3179R	BWP	18-510
M-2602R	BWP	17-700	M-3181L	BWP	18-787
M-2603L	BWP	17-649	M-3181R	BWP	18-786
M-2603R	BWP	17-648	M-3183L	BWP	17-597
M-2604L	BWP	17-637	M-3183R	BWP	17-596
M-2604R	BWP	17-636	M-3895	BWP	17-642
M-2605L	BWP	18-505	M-3896	BWP	17-643
M-2605L	BWP	18-825	M-3897	BWP	17-628
M-2605R	BWP	18-504	M-3898	BWP	17-629
M-2605R	BWP	18-824	M-3899	BWP	17-632
M-2606L	BWP	18-525	M-3900	BWP	17-633
M-2606R	BWP	18-524	M-3997	BWP	17-629
M-2607L	BWP	18-527	M-3998	BWP	17-628
M-2607L	BWP	18-837	M-4001	BWP	17-620
M-2607R	BWP	18-526	M-4002	BWP	17-621
M-2607R	BWP	18-836	M-4003	BWP	17-622
M-2609L	BWP	18-857	M-4004	BWP	17-623
M-2609R	BWP	18-856	M-4008	BWP	17-576
M-2610L	BWP	18-853	M-4009	BWP	17-577
M-2610R	BWP	18-852	M-4010	BWP	18-808
M-2611L	BWP	18-807	M-4011	BWP	18-809
M-2611R	BWP	18-806	M-4014	BWP	17-626
M-2612L	BWP	18-515	M-4015	BWP	17-627
M-2612L	BWP	18-829	M-4016	BWP	17-640
M-2612R	BWP	18-514	M-4017	BWP	17-641
M-2612R	BWP	18-828	M-4018	BWP	17-631
M-2613L	BWP	18-517	M-4019	BWP	17-630
M-2613L	BWP	18-831	M-477L	BWP	17-685
M-2613R	BWP	18-516	M-477R	BWP	17-684
M-2613R	BWP	18-830	M-478L	BWP	17-691
M-2614L	BWP	18-519	M-478R	BWP	17-690

CROSS REFERENCE

Manufacturer Number	Manufacturer	Spicer Number	Manufacturer Number	Manufacturer	Spicer Number
M-479L	BWP	17-695	M-990R	BWP	17-626
M-479R	BWP	17-694	M-990R	BWP	17-720
M-496L	BWP	17-699	M-990R	BWP	17-810
M-496R	BWP	17-698	M-991L	BWP	17-629
M-557L	BWP	17-11071	M-991L	BWP	17-723
M-557R	BWP	17-11072	M-991L	BWP	17-813
M-558L	BWP	17-599	M-991R	BWP	17-628
M-558R	BWP	17-598	M-991R	BWP	17-722
M-559L	BWP	17-579	M-991R	BWP	17-812
M-559R	BWP	17-578	M-992L	BWP	17-631
M-560L	BWP	17-585	M-992L	BWP	17-725
M-560L	BWP	17-599	M-992L	BWP	17-815
M-560R	BWP	17-584	M-992R	BWP	17-630
M-560R	BWP	17-598	M-992R	BWP	17-724
M-561L	BWP	17-577	M-992R	BWP	17-814
M-561R	BWP	17-576	M-993L	BWP	17-641
M-562L	BWP	17-581	M-993R	BWP	17-640
M-562R	BWP	17-580	M-994L	BWP	17-633
M-563L	BWP	17-621	M-994R	BWP	17-632
M-563R	BWP	17-620	M-995L	BWP	17-643
M-566L	BWP	17-623	M-995R	BWP	17-642
M-566R	BWP	17-622	M-996L	BWP	18-805
M-567L	BWP	17-583	M-996R	BWP	18-804
M-567R	BWP	17-582	M-997L	BWP	18-809
M-743L	BWP	18-811	M-997R	BWP	18-808
M-743R	BWP	18-810	M-998L	BWP	18-813
M-744L	BWP	17-575	M-998R	BWP	18-812
M-744R	BWP	17-574	P16WKL30-164	Spicer OE	17-621
M-746L	BWP	17-587	P16WKL30-214	Spicer OE	17-623
M-746R	BWP	17-586	P16WKR30-164	Spicer OE	17-620
M-774L	BWP	17-579	P16WKR30-214	Spicer OE	17-622
M-774R	BWP	17-578	R16WKL10-066	Spicer OE	18-801
M-776L	BWP	17-683	R16WKL10-082	Spicer OE	18-803
M-776R	BWP	17-682	R16WKL10-084	Spicer OE	18-855
M-778L	BWP	18-785	R16WKL10-087	Spicer OE	18-805
M-778R	BWP	18-784	R16WKL10-096	Spicer OE	18-783
M-988L	BWP	18-801	R16WKL10-104	Spicer OE	18-785
M-988R	BWP	18-800	R16WKL10-114	Spicer OE	18-809
M-989L	BWP	18-803	R16WKL10-117	Spicer OE	18-811
M-989R	BWP	18-802	R16WKL10-121	Spicer OE	18-787
M-990L	BWP	17-627	R16WKL10-127	Spicer OE	18-813
M-990L	BWP	17-721	R16WKL10-227	Spicer OE	17-585
M-990L	BWP	17-811	R16WKL13-175	Spicer OE	17-641

Manufacturer Number	Manufacturer	Spicer Number	Manufacturer Number	Manufacturer	Spicer Number
R16WKL13-206	Spicer OE	17-633	R16WKR20-175	Spicer OE	17-626
R16WKL13-243	Spicer OE	17-643	R16WKR20-206	Spicer OE	17-628
R16WKL20-084	Spicer OE	18-861	R16WKR20-243	Spicer OE	17-630
R16WKL20-087	Spicer OE	18-825	R607001	Meritor / Rockwell	17-574
R16WKL20-097	Spicer OE	18-865	R607002	Meritor / Rockwell	17-575
R16WKL20-101	Spicer OE	18-889	R607003	Meritor / Rockwell	17-682
R16WKL20-107	Spicer OE	18-827	R607004	Meritor / Rockwell	17-683
R16WKL20-112	Spicer OE	18-829	R607005	Meritor / Rockwell	17-684
R16WKL20-114	Spicer OE	18-831	R607006	Meritor / Rockwell	17-685
R16WKL20-117	Spicer OE	18-833	R607007	Meritor / Rockwell	17-694
R16WKL20-132	Spicer OE	18-837	R607008	Meritor / Rockwell	17-695
R16WKL20-134	Spicer OE	18-821	R607009	Meritor / Rockwell	17-690
R16WKL20-136	Spicer OE	18-823	R607010	Meritor / Rockwell	17-691
R16WKL20-143	Spicer OE	18-835	R607011	Meritor / Rockwell	17-621
R16WKL20-175	Spicer OE	17-627	R607012	Meritor / Rockwell	17-620
R16WKL20-206	Spicer OE	17-629	R607015	Meritor / Rockwell	18-738
R16WKL20-243	Spicer OE	17-631	R607016	Meritor / Rockwell	18-739
R16WKR10-066	Spicer OE	18-800	R607017	Meritor / Rockwell	18-784
R16WKR10-082	Spicer OE	18-802	R607018	Meritor / Rockwell	18-785
R16WKR10-084	Spicer OE	18-854	R607019	Meritor / Rockwell	17-622
R16WKR10-087	Spicer OE	18-804	R607020	Meritor / Rockwell	17-623
R16WKR10-096	Spicer OE	18-782	R607021	Meritor / Rockwell	17-11072
R16WKR10-104	Spicer OE	18-784	R607022	Meritor / Rockwell	17-11071
R16WKR10-114	Spicer OE	18-808	R607023	Meritor / Rockwell	17-698
R16WKR10-117	Spicer OE	18-810	R607024	Meritor / Rockwell	17-699
R16WKR10-121	Spicer OE	18-786	R607025	Meritor / Rockwell	17-634
R16WKR10-127	Spicer OE	18-812	R607026	Meritor / Rockwell	17-635
R16WKR10-227	Spicer OE	17-584	R607027	Meritor / Rockwell	18-848
R16WKR13-175	Spicer OE	17-640	R607028	Meritor / Rockwell	18-849
R16WKR13-206	Spicer OE	17-632	R607029	Meritor / Rockwell	18-740
R16WKR13-243	Spicer OE	17-642	R607030	Meritor / Rockwell	18-741
R16WKR20-084	Spicer OE	18-860	R607031	Meritor / Rockwell	17-568
R16WKR20-087	Spicer OE	18-824	R607032	Meritor / Rockwell	17-569
R16WKR20-097	Spicer OE	18-864	R607033	Meritor / Rockwell	17-588
R16WKR20-101	Spicer OE	18-888	R607034	Meritor / Rockwell	17-589
R16WKR20-107	Spicer OE	18-826	R607035	Meritor / Rockwell	18-726
R16WKR20-112	Spicer OE	18-828	R607036	Meritor / Rockwell	18-727
R16WKR20-114	Spicer OE	18-830	R607037	Meritor / Rockwell	18-746
R16WKR20-117	Spicer OE	18-832	R607038	Meritor / Rockwell	18-747
R16WKR20-132	Spicer OE	18-836	R607039	Meritor / Rockwell	17-570
R16WKR20-134	Spicer OE	18-820	R607040	Meritor / Rockwell	17-571
R16WKR20-136	Spicer OE	18-822	R607041	Meritor / Rockwell	17-586
R16WKR20-143	Spicer OE	18-834	R607042	Meritor / Rockwell	17-587

CROSS REFERENCE

Manufacturer Number	Manufacturer	Spicer Number	Manufacturer Number	Manufacturer	Spicer Number
R607043	Meritor / Rockwell	17-596	R607134	Meritor / Rockwell	18-766
R607044	Meritor / Rockwell	17-597	R607135	Meritor / Rockwell	18-777
R607045	Meritor / Rockwell	17-636	R607136	Meritor / Rockwell	18-776
R607046	Meritor / Rockwell	17-637	R607137	Meritor / Rockwell	18-771
R607047	Meritor / Rockwell	17-638	R607138	Meritor / Rockwell	18-770
R607048	Meritor / Rockwell	17-639	R607139	Meritor / Rockwell	18-775
R607049	Meritor / Rockwell	18-743	R607140	Meritor / Rockwell	18-774
R607050	Meritor / Rockwell	18-742	R607141	Meritor / Rockwell	18-765
R607051	Meritor / Rockwell	17-598	R607142	Meritor / Rockwell	18-764
R607052	Meritor / Rockwell	17-599	R607143	Meritor / Rockwell	18-769
R607101	Meritor / Rockwell	17-567	R607144	Meritor / Rockwell	18-768
R607102	Meritor / Rockwell	17-566	R607145	Meritor / Rockwell	18-779
R607103	Meritor / Rockwell	18-745	R607146	Meritor / Rockwell	18-778
R607104	Meritor / Rockwell	18-744	R607147	Meritor / Rockwell	18-733
R607105	Meritor / Rockwell	18-943	R607148	Meritor / Rockwell	18-732
R607106	Meritor / Rockwell	18-942	R607149	Meritor / Rockwell	18-737
R607107	Meritor / Rockwell	17-463	R607150	Meritor / Rockwell	18-736
R607108	Meritor / Rockwell	17-462	R607151	Meritor / Rockwell	18-983
R607109	Meritor / Rockwell	17-461	R607152	Meritor / Rockwell	18-982
R607110	Meritor / Rockwell	17-460	R607153	Meritor / Rockwell	18-985
R607111	Meritor / Rockwell	18-941	R607154	Meritor / Rockwell	18-984
R607112	Meritor / Rockwell	18-940	R607155	Meritor / Rockwell	18-945
R607113	Meritor / Rockwell	17-473	R607156	Meritor / Rockwell	18-944
R607114	Meritor / Rockwell	17-472	R607161	Meritor / Rockwell	17-616
R607115	Meritor / Rockwell	17-471	R607162	Meritor / Rockwell	17-617
R607116	Meritor / Rockwell	17-470	R607163	Meritor / Rockwell	17-615
R607117	Meritor / Rockwell	18-973	R607164	Meritor / Rockwell	17-614
R607118	Meritor / Rockwell	18-972	R607165	Meritor / Rockwell	17-681
R607119	Meritor / Rockwell	18-975	R607166	Meritor / Rockwell	17-680
R607120	Meritor / Rockwell	18-974	R607167	Meritor / Rockwell	17-649
R607121	Meritor / Rockwell	18-963	R607168	Meritor / Rockwell	17-648
R607122	Meritor / Rockwell	18-962	R607169	Meritor / Rockwell	17-481
R607123	Meritor / Rockwell	18-979	R607170	Meritor / Rockwell	17-480
R607124	Meritor / Rockwell	18-978	R607171	Meritor / Rockwell	17-483
R607125	Meritor / Rockwell	18-749	R607172	Meritor / Rockwell	17-482
R607126	Meritor / Rockwell	18-748	R607173	Meritor / Rockwell	17-517
R607127	Meritor / Rockwell	18-761	R607174	Meritor / Rockwell	17-516
R607128	Meritor / Rockwell	18-760	R607175	Meritor / Rockwell	17-505
R607129	Meritor / Rockwell	18-763	R607176	Meritor / Rockwell	17-504
R607130	Meritor / Rockwell	18-762	R607177	Meritor / Rockwell	17-509
R607131	Meritor / Rockwell	18-773	R607178	Meritor / Rockwell	17-508
R607132	Meritor / Rockwell	18-772	R607179	Meritor / Rockwell	17-513
R607133	Meritor / Rockwell	18-767	R607180	Meritor / Rockwell	17-512

Manufacturer Number	Manufacturer	Spicer Number	Manufacturer Number	Manufacturer	Spicer Number
R607181	Meritor / Rockwell	17-501	R607224	Meritor / Rockwell	17-506
R607182	Meritor / Rockwell	17-500	R607225	Meritor / Rockwell	17-523
R607183	Meritor / Rockwell	17-503	R607226	Meritor / Rockwell	17-522
R607184	Meritor / Rockwell	17-502	R607227	Meritor / Rockwell	17-915
R607185	Meritor / Rockwell	17-519	R607228	Meritor / Rockwell	17-914
R607186	Meritor / Rockwell	17-518	R607229	Meritor / Rockwell	17-921
R607187	Meritor / Rockwell	17-555	R607230	Meritor / Rockwell	17-920
R607188	Meritor / Rockwell	17-554	R607231	Meritor / Rockwell	17-929
R607189	Meritor / Rockwell	17-485	R607232	Meritor / Rockwell	17-928
R607190	Meritor / Rockwell	17-484	R607233	Meritor / Rockwell	17-941
R607191	Meritor / Rockwell	17-591	R607234	Meritor / Rockwell	17-940
R607192	Meritor / Rockwell	17-590	R607235	Meritor / Rockwell	17-537
R607193	Meritor / Rockwell	17-593	R607236	Meritor / Rockwell	17-536
R607194	Meritor / Rockwell	17-592	R607237	Meritor / Rockwell	17-557
R607195	Meritor / Rockwell	17-531	R607238	Meritor / Rockwell	17-556
R607196	Meritor / Rockwell	17-530	R607239	Meritor / Rockwell	17-677
R607197	Meritor / Rockwell	17-511	R607240	Meritor / Rockwell	17-676
R607198	Meritor / Rockwell	17-510	R607241	Meritor / Rockwell	17-693
R607199	Meritor / Rockwell	17-515	R607242	Meritor / Rockwell	17-692
R607200	Meritor / Rockwell	17-514	R607243	Meritor / Rockwell	17-697
R607201	Meritor / Rockwell	17-735	R607244	Meritor / Rockwell	17-696
R607202	Meritor / Rockwell	17-734	R607245	Meritor / Rockwell	17-737
R607203	Meritor / Rockwell	17-745	R607246	Meritor / Rockwell	17-736
R607204	Meritor / Rockwell	17-744	R607247	Meritor / Rockwell	17-795
R607205	Meritor / Rockwell	17-751	R607248	Meritor / Rockwell	17-794
R607206	Meritor / Rockwell	17-750	R607249	Meritor / Rockwell	17-787
R607207	Meritor / Rockwell	17-755	R607250	Meritor / Rockwell	17-786
R607208	Meritor / Rockwell	17-754	R607251	Meritor / Rockwell	17-797
R607209	Meritor / Rockwell	17-757	R607252	Meritor / Rockwell	17-796
R607210	Meritor / Rockwell	17-756	R607253	Meritor / Rockwell	17-783
R607211	Meritor / Rockwell	17-761	R607254	Meritor / Rockwell	17-782
R607212	Meritor / Rockwell	17-760	R607259	Meritor / Rockwell	17-625
R607213	Meritor / Rockwell	17-763	R607260	Meritor / Rockwell	17-624
R607214	Meritor / Rockwell	17-762	R607261	Meritor / Rockwell	18-735
R607215	Meritor / Rockwell	17-765	R607262	Meritor / Rockwell	18-734
R607216	Meritor / Rockwell	17-764	R607263	Meritor / Rockwell	17-619
R607217	Meritor / Rockwell	17-771	R607264	Meritor / Rockwell	17-618
R607218	Meritor / Rockwell	17-770	R607265	Meritor / Rockwell	17-740
R607219	Meritor / Rockwell	17-561	R607266	Meritor / Rockwell	17-741
R607220	Meritor / Rockwell	17-560	R607267	Meritor / Rockwell	17-11055
R607221	Meritor / Rockwell	17-479	R607268	Meritor / Rockwell	17-11056
R607222	Meritor / Rockwell	17-478	R607269	Meritor / Rockwell	17-403
R607223	Meritor / Rockwell	17-507	R607270	Meritor / Rockwell	17-402

CROSS REFERENCE

Manufacturer Number	Manufacturer	Spicer Number	Manufacturer Number	Manufacturer	Spicer Number
R607271	Meritor / Rockwell	17-415	R615016	Meritor / Rockwell	43-7064
R607272	Meritor / Rockwell	17-414	R615018	Meritor / Rockwell	43-7068
R607273	Meritor / Rockwell	17-417	R615020	Meritor / Rockwell	43-7090
R607274	Meritor / Rockwell	17-416	R65021	Meritor / Rockwell	43-7115
R607275	Meritor / Rockwell	17-419	R67011	Meritor / Rockwell	17-620
R607276	Meritor / Rockwell	17-418	S-20806-1L	Intraax	17-11055
R607277	Meritor / Rockwell	17-931	S-20806-1R	Intraax	17-11056
R607278	Meritor / Rockwell	17-930	TP-1166	Transit	17-588
R607279	Meritor / Rockwell	18-995	TP-1167	Transit	17-589
R607280	Meritor / Rockwell	18-994	TP-1168	Transit	17-596
R607281	Meritor / Rockwell	18-997	TP-1169	Transit	17-597
R607282	Meritor / Rockwell	18-996	TP-1196	Transit	17-621
R607283	Meritor / Rockwell	18-1127	TP-1198	Transit	17-620
R607284	Meritor / Rockwell	18-1128	TP-1400	Transit	17-623
R607285	Meritor / Rockwell	17-11057	TP-1402	Transit	17-622
R607286	Meritor / Rockwell	17-11058	TP-1460	Transit	17-684
R607287	Meritor / Rockwell	17-11059	TP-1461	Transit	17-685
R607288	Meritor / Rockwell	17-11060	TP-1462	Transit	17-694
R607289	Meritor / Rockwell	17-11061	TP-1463	Transit	17-695
R607290	Meritor / Rockwell	17-11062	TP-1464	Transit	17-690
R607291	Meritor / Rockwell	17-11063	TP-1465	Transit	17-691
R607292	Meritor / Rockwell	17-11064	TP-1489	Transit	17-624
R607293	Meritor / Rockwell	17-11065	TP-1490	Transit	17-625
R607294	Meritor / Rockwell	17-11066	TP-1567	Transit	18-785
R607295	Meritor / Rockwell	17-11067	TP-1568	Transit	18-784
R607296	Meritor / Rockwell	17-11068	TP-158	Transit	18-852
R607297	Meritor / Rockwell	17-11069	TP-159	Transit	18-853
R607298	Meritor / Rockwell	17-11070	TP-1593	Transit	18-738
R615000	Meritor / Rockwell	43-7040	TP-1594	Transit	18-739
R615001	Meritor / Rockwell	43-7031	TP-1597	Transit	18-808
R615002	Meritor / Rockwell	43-7041	TP-1598	Transit	18-809
R615003	Meritor / Rockwell	43-7042	TP-160	Transit	18-812
R615004	Meritor / Rockwell	43-7043A	TP-161	Transit	18-813
R615005	Meritor / Rockwell	43-7039	TP-1634	Transit	43-7031
R615006	Meritor / Rockwell	43-7038	TP-1635	Transit	43-7039
R615007	Meritor / Rockwell	43-7030	TP-1639	Transit	43-7042
R615008	Meritor / Rockwell	43-7032	TP-1640	Transit	43-7041
R615009	Meritor / Rockwell	43-7029	TP-1641	Transit	43-7034
R615010	Meritor / Rockwell	43-7033	TP-1642	Transit	43-7044
R615011	Meritor / Rockwell	43-7053A	TP-1644	Transit	43-7038
R615013	Meritor / Rockwell	43-7060	TP-1647	Transit	17-572
R615014	Meritor / Rockwell	43-7062	TP-1648	Transit	17-573
R615015	Meritor / Rockwell	43-7069	TP-175	Transit	17-566

CROSS REFERENCE

Manufacturer Number	Manufacturer	Spicer Number	Manufacturer Number	Manufacturer	Spicer Number
TP-1752	Transit	18-804	TP-3064	Transit	17-698
TP-1753	Transit	18-805	TP-3065	Transit	17-699
TP-176	Transit	17-567	TP-3066	Transit	17-634
TP-177	Transit	17-584	TP-3067	Transit	17-635
TP-178	Transit	17-585	TP-3092	Transit	17-638
TP-1792	Transit	17-568	TP-3093	Transit	17-639
TP-1793	Transit	17-569	TP-323	Transit	18-818
TP-1901	Transit	17-626	TP-324	Transit	18-819
TP-1901	Transit	17-810	TP-325	Transit	18-810
TP-1902	Transit	17-627	TP-326	Transit	18-811
TP-1902	Transit	17-811	TP-327	Transit	18-742
TP-1957	Transit	18-726	TP-328	Transit	18-743
TP-1958	Transit	18-727	TP-329	Transit	18-730
TP-1959	Transit	18-740	TP-330	Transit	18-731
TP-1960	Transit	18-741	TP-331	Transit	18-728
TP-2038	Transit	18-806	TP-332	Transit	18-729
TP-2039	Transit	18-807	TP-507	Transit	17-580
TP-251	Transit	17-618	TP-508	Transit	17-581
TP-252	Transit	17-619	TP-548	Transit	17-582
TP-296	Transit	17-682	TP-549	Transit	17-583
TP-297	Transit	17-683	TP-550	Transit	18-840
TP-300	Transit	17-586	TP-551	Transit	18-841
TP-301	Transit	17-587	TP-552	Transit	17-576
TP-302	Transit	17-574	TP-553	Transit	17-577
TP-303	Transit	17-575	TP-554	Transit	18-744
TP-3043	Transit	17-628	TP-555	Transit	18-745
TP-3043	Transit	17-722	TP-556	Transit	18-750
TP-3043	Transit	17-812	TP-557	Transit	18-751
TP-3044	Transit	17-629	TP-583	Transit	17-578
TP-3044	Transit	17-723	TP-584	Transit	17-579
TP-3044	Transit	17-813	TP-592	Transit	17-598
TP-3045	Transit	17-630	TP-593	Transit	17-599
TP-3045	Transit	17-724	TP-8503	Transit	18-802
TP-3045	Transit	17-814	TP-8504	Transit	18-803
TP-3046	Transit	17-631	TP-8508	Transit	17-648
TP-3046	Transit	17-725	TP-8509	Transit	17-649
TP-3046	Transit	17-815	TP-8519	Transit	18-842
TP-3047	Transit	17-640	TP-8520	Transit	18-843
TP-3048	Transit	17-641	TP-8525	Transit	17-570
TP-3049	Transit	17-632	TP-8526	Transit	17-571
TP-3050	Transit	17-633	TP-8528	Transit	18-516
TP-3051	Transit	17-642	TP-8528	Transit	18-830
TP-3052	Transit	17-643	TP-8529	Transit	18-517

Manufacturer Number	Manufacturer	Spicer Number	Manufacturer Number	Manufacturer	Spicer Number
TP-8529	Transit	18-831			
TP-8530	Transit	18-518			
TP-8530	Transit	18-832			
TP-8531	Transit	18-519			
TP-8531	Transit	18-833			
TP-8532	Transit	18-534			
TP-8532	Transit	18-834			
TP-8533	Transit	18-535			
TP-8533	Transit	18-835			
TP-8534	Transit	18-510			
TP-8534	Transit	18-826			
TP-8535	Transit	18-511			
TP-8535	Transit	18-827			
TP-8540	Transit	18-844			
TP-8541	Transit	18-845			
TP-8542	Transit	18-846			
TP-8543	Transit	18-847			
TP-8544	Transit	18-848			
TP-8545	Transit	18-849			
TP-8546	Transit	18-880			
TP-8547	Transit	18-881			
TP-8551	Transit	43-7037			
TP-8552	Transit	43-7037A			
TP-8554	Transit	43-7032			
TP-8555	Transit	43-7040			
TP-8557	Transit	43-7033			
TP-8580	Transit	18-856			
TP-8580	Transit	18-950			
TP-8581	Transit	18-857			
TP-8581	Transit	18-951			
TP-8582	Transit	18-956			
TP-8583	Transit	18-957			
TP-8588	Transit	18-540			
TP-8588	Transit	18-878			
TP-8589	Transit	18-541			
TP-8589	Transit	18-879			
TP-8614	Transit	18-790			
TP-8615	Transit	18-791			
TP-8616	Transit	18-724			
TP-8617	Transit	18-725			
TP-8620	Transit	18-786			

ABS: Anti-Lock Braking System

Actuator: A device which physically initiates the mechanical motion of a brake system component.

Air Disc Brakes (ADB): Air-actuated brakes, which upon application, employ a caliper to clamp two brake pads against a rotor. Air discs, compared with drum-type brakes, have superior ability to resist fade.

AL Factor: A mathematical expression of the brake chamber and slack adjuster combination. "A" equals the effective area, in square inches, of the brake chamber diaphragm. "L" equals the effective length, in inches, of the slack adjuster. For example, 30 (air chamber) x 6 (slack adjuster) = 180AL Factor.

Anchor Pin: A pin or pins inserted in the brake spider to which the brake shoes attach and pivot upon.

Anti-compounding: A system that prevents application of service brakes from compounding (adding) to the force exerted by parking brakes. Functionally, this guards against brake drum cracking, brake shoe and brake lining damage.

Anti-Lock: Optional on trailers until March 1, 1998, a safety oriented system which senses wheel rotation (at one or more axles) during braking and cycles the brakes to prevent wheel lockup.

ASA: Automatic slack adjuster

ATA: American Trucking Association

ATC: Automatic traction control

BBW: Brake by wire

BCN: Brake certification notice

Bell-Mounted Drum: Drum with variation of inner diameter (i.e., greater at open end), preventing full contact with brake linings.

Blue Drum: Brake drum with friction surface blued from high temperature. High temperature may result, for example, from dragging of brakes caused by weak return springs. Blue drum also may result from lack of brake balance.

Brake Block: Friction material or lining attached to brake shoe.

Brake Chamber Diaphragm: A device within the brake chamber that converts air pressure to mechanical force via a push rod.

Brake Drag: Failure of one or more brakes to release immediately and/or completely after driver removes his foot from the brake treadle. Constant drag, unrelated to a brake application, also can exist.

Brake Fade: Brake fade results from a reduction in friction between linings and drums caused by exposure to water, dragging brakes on a down-grade or over-adjusted brakes resulting in an over-heated brake drum. Heat fade occurs when linings overheat and become less aggressive. Gradual and predictable fade is desirable as a warning. (Silver and Yellow will glaze if not burnished.)

Burnish: The conditioning or seasoning of a brake lining by wear and temperature via a test procedure or in-service operation.

Caliper: In an air disc brake system, the clamping device to which the friction material is attached. When actuated, the caliper applies braking force to both sides of the rotor.

Cam Base Circle Radius: The perpendicular distance from the center of the s-cam to the vector defined by the center of the cam roller and the intersection of the cam roller with the s-cam profile. Most CBCR are designed to be at or near 1/2 inch.

Clevis pin: Pin connecting the arm of slack adjuster to a brake chamber push rod yoke.

CMVSS: Canadian Motor Vehicle Safety Standard

Coefficient of Friction: Developed by Friction Materials Standards Institute, a double-letter code printed on the edge of a brake block to designate its range of aggressiveness. (Example: EE, FF, GG, FG)

Cracked Drum: Brake drum cracked all the way through by excessive heat build-up (perhaps signifying inadequate drum weight and/or driver abuse) and/or resurfacing of a drum beyond the manufacturer's limit.

CTI: Central tire inflation

Dual Brake System: Mandated by FMVSS 121, the use of a dual air system (primary and secondary) in order to retain braking ability in the event one system fails.

Dust Shield: A plate made of metal or polyethylene that is mounted behind a brake drum to minimize the entry of dirt and road splash.

EBS: Electronic braking system

ECU: Electronic control unit

Edge Code: The information found the edge of a brake block. Spicer friction edge coding includes the type of friction and the coefficient of friction.

Emergency Brake System: Not a separate system, emergency braking (in event of air loss) involves various portions of the parking and service brake systems.

Engine Brake: An optional device that converts a diesel engine into a power-absorbing air compressor to slow a vehicle on downgrades.

ES: Extended Service, Eaton's term for brake design using thicker than standard lining.

ESII: Eaton's redesigned Extended Service brake shoe, introduced in 1996. It employs a new Hot Staked manufacturing process, redesigned retaining springs, lighter weight and elimination of the tabs from the previous design table.

Exhaust Brake: An optional device that uses engine exhaust back pressure to slow a vehicle on downgrades.

FC: Fast Change, Spicer's term for brake design with an open anchor pin rib. Interchanges with Rockwell Q design.

FCII: Spicer's redesigned 12-1/4 Fast Change brake shoe, introduced in 1996. It includes a redesigned table, thicker rib material, an improved welding process, and standardization of brake hardware components.

FMSI: Friction Materials Standards Institute

FMVSS: Federal Motor Vehicle Safety Standard

Foundation Brake System: A term inclusive of mechanical components involved in mechanically providing braking force: brake chambers, slack adjusters, brake drums, brake shoe assemblies.

FT: Fabricated, Tapered, Spicer's term for brake design with a closed anchor pin rib. Interchanges with Rockwell P design.

GAW: Gross axle weight

GAWR: Gross Axle Weight Rating, a rating in pounds of brake lining material, or axle carrying capacity.

GCW: Gross combination weight: the total weight carrying capacity of a combination vehicle as determined by axle ratings.

GCWR: Gross combination weight rating

Grease-Stained Drum: A brake drum with discoloration of the friction surface caused by, for example, improper greasing of brake camshaft.

GVW: Gross vehicle weight: the total weight carrying capacity of one vehicle, (such as a straight truck, bus, tractor or trailer) as determined by axle ratings.

GVWR: Gross vehicle weight rating

HA: Suffix used to denote brake shoes used on axles produced by Spicer's Heavy Axle & Brake Division.

HDBMC: Heavy Duty Brake Manufacturer's Council

Heat-Checked Drums: A brake drum with a pattern of hard, slightly raised, dark spots on its friction surface. Caused by localized overheating and sudden cooling. Those spots should be ground off to prevent drum cracking, uneven lining wear and loss of braking efficiency. If spots cannot be removed, the drum should be discarded.

Lining Growth: Permanent swelling of brake linings due to heat exposure.

Lining Number : Numbers shown are FMSI (Friction Materials Standards Institute) standards and fit the corresponding brake shoe core.

NHTSA: National Highway Transportation Safety Administration

Out-Of-Round Drum: A brake drum with variations in its inner diameter, causing reduced braking efficiency and excessive wear on one side of the brake linings. An out-of-round drum often can be machined, within manufacturer's limits, to restore concentricity.

Over-Sized Drum: This refers to a brake drum having an inner diameter greater than the discard diameter marked on the drum by its manufacturer.

P Brake: Rockwell's term for brake design with a closed anchor pin rib. Interchanges with Spicer FT design.

PM: Preventive maintenance

Polished Drums: A brake drum with a friction surface polished to a mirror-like finish by unsuitable brake linings. Remove gloss from drum with eighty grit emery cloth.

Push Rod: A rod, protruding from a brake chamber, which is connected to the arm of a slack adjuster via a clevis pin.

Q Brake: Quick-change, Rockwell's term for brake design with an open anchor pin rib. Interchanges with Spicer FC design.

Q Plus: Rockwell's term for a quick-change design brake shoe using thicker than standard lining.

R12: Pilot control air valve with quick dump

R14: Pilot control air valve with quick dump and anti-compounding

REB: Eaton's new 15" design Reduced Envelope Brake.

Replace-A-Brake: Spicer's term for a kit to service one brake assembly. It includes two new lined brake shoes and the necessary anchor pins, rollers, springs, etc.

Retarder: Auxiliary brake device: engine brake, exhaust brake, hydraulic retarder or electric retarder.

Return Springs: Springs which retract brake shoes upon release of the brake actuator valve.

RFI: Radio frequency interference

Roll Over: A term denoting that an s-cam has traveled beyond its designed stopping position during brake application.

RP: Recommended practice

SAE: Society of Automotive Engineers

SAP: Single Anchor Pin, Eaton's term for brake design utilizing one non-replaceable anchor pin per brake assembly.

S-cam Brake: A type of brake where mechanically induced rotation of an S shaped cam forces brake linings against the brake drum.

Scored Drum: Brake drum with a grooved friction surface, resulting in excessive lining wear. Severe scoring requires that a drum be machined, within manufacturer's limits, before replacing the linings.

Service Brakes: As opposed to parking brakes, that portion of the brake system used for normal brake applications.

Slack Adjuster: A lever, connecting the brake push rod with the foundation brake camshaft, which provides torque to rotate the brake camshaft when the brake treadle is depressed. Used only on cam-actuated brakes, it also provides a means of adjusting clearance between the brake shoes and the drum to compensate for lining wear. Some models are automatic, requiring proper installation procedures and requiring periodic inspection to insure proper functioning. Manual slack adjusters require proper installation and manual adjustment at maintenance intervals.

SLR: Static loaded radius

Spring Brake: Generally refers to a tandem chamber actuator that incorporates an air-applied service brake chamber or an air-released/spring applied parking or emergency brake chamber. Spring brakes apply upon sudden air loss (emergency mode) or activation of a dash-mounted parking brake control. Spring brakes remain applied until that chamber is recharged or the spring is manually compressed or caged. The spring portion often is referred to as the piggyback. Some spring brake actuators do not incorporate a service air chamber and are solely parking and emergency brakes. For example, some parking brakes are applied by air pressure and subsequently held mechanically by a pawl which drops into a notch on the brake chamber push rod.

Stroke: Refers to a total distance traveled by a brake chamber push rod or slack adjuster arm during brake application.

Supply Tank: The air reservoir immediately downstream of the air compressor.

T Brake: Rockwell's term for a front brake shoe design using a single web with a closed anchor pin end.

Threaded Drum: Brake drum resurfaced on a lathe too quickly, resulting in a friction surface similar to that of a scored drum.

Tire Rolling Radius: The distance, expressed in inches, from the center of a tire to the pavement, measured when mounted on a vehicle and loaded to its maximum capacity.

TMC: Maintenance Council

Turned Drum: A brake drum that has been resurfaced on a lathe to remove scoring or other defects.

Wedge Brake: As opposed to a brake applied by a s-cam, this type of brake is applied by a single or double wedge type mechanism. This type of brake is self-adjusting and, as such, does not utilize a slack adjuster.

XEM: Xtra Easy Maintenance, Fruehauf's term for brake design with an open anchor pin rib. This shoe will not interchange with Rockwell Q and Spicer FC shoes.

XtraLife: Spicer's term for a quick-change design brake shoe using thicker than standard lining. Available in both the original XtraLife design, and the new XtraLife II version.

PART NUMBER INDEX

UHB800-CAM

17-11055.....	76	17-470.....	70	17-536.....	111	17-586.....	79
17-11056.....	76	17-471.....	70	17-537.....	111	17-587.....	79
17-11057.....	65	17-472.....	70	17-538.....	113	17-588.....	80
17-11058.....	65	17-473.....	70	17-539.....	113	17-589.....	80
17-11059.....	65	17-478.....	103	17-540.....	111	17-590.....	80
17-11060.....	65	17-479.....	103	17-541.....	111	17-591.....	80
17-11061.....	65	17-480.....	103	17-542.....	111	17-592.....	80
17-11062.....	65	17-481.....	103	17-543.....	111	17-593.....	80
17-11063.....	65	17-482.....	103	17-544.....	111	17-594.....	79
17-11064.....	65	17-483.....	103	17-545.....	111	17-595.....	79
17-11065.....	65	17-484.....	103	17-546.....	111	17-596.....	80
17-11066.....	65	17-485.....	103	17-547.....	111	17-597.....	80
17-11067.....	65	17-490.....	107	17-548.....	111	17-598.....	81
17-11068.....	65	17-491.....	107	17-549.....	111	17-599.....	81
17-11069.....	66	17-492.....	107	17-550.....	112	17-600.....	104
17-11070.....	66	17-493.....	107	17-551.....	112	17-601.....	104
17-11071.....	72	17-500.....	106	17-552.....	112	17-602.....	104
17-11072.....	72	17-501.....	106	17-553.....	112	17-603.....	104
17-400.....	92	17-502.....	107	17-554.....	113	17-604.....	104
17-401.....	92	17-503.....	107	17-555.....	113	17-605.....	104
17-402.....	92	17-504.....	112	17-556.....	113	17-606.....	104
17-403.....	92	17-505.....	112	17-557.....	113	17-607.....	104
17-404.....	92	17-506.....	113	17-558.....	113	17-608.....	105
17-405.....	92	17-507.....	113	17-559.....	113	17-609.....	105
17-406.....	92	17-508.....	112	17-560.....	77	17-610.....	105
17-407.....	92	17-509.....	112	17-561.....	77	17-611.....	105
17-408.....	92	17-510.....	107	17-562.....	112	17-612.....	105
17-409.....	92	17-511.....	107	17-563.....	112	17-613.....	105
17-410.....	92	17-512.....	106	17-564.....	113	17-614.....	74
17-411.....	92	17-513.....	106	17-565.....	113	17-615.....	74
17-412.....	92	17-514.....	107	17-566.....	78	17-616.....	75
17-413.....	92	17-515.....	107	17-567.....	78	17-617.....	75
17-414.....	92	17-516.....	111	17-568.....	81	17-618.....	73
17-415.....	92	17-517.....	111	17-569.....	81	17-619.....	73
17-416.....	93	17-518.....	112	17-570.....	77	17-620.....	75
17-417.....	93	17-519.....	112	17-571.....	77	17-621.....	75
17-418.....	93	17-520.....	106	17-572.....	77	17-622.....	75
17-419.....	93	17-521.....	106	17-573.....	77	17-623.....	75
17-420.....	93	17-522.....	108	17-574.....	79	17-624.....	73
17-421.....	93	17-523.....	108	17-575.....	79	17-625.....	73
17-424.....	93	17-524.....	106	17-576.....	77	17-626.....	84
17-425.....	93	17-525.....	106	17-577.....	77	17-627.....	84
17-438.....	102	17-526.....	107	17-578.....	78	17-628.....	84
17-439.....	102	17-527.....	107	17-579.....	78	17-629.....	84
17-442.....	102	17-528.....	108	17-580.....	81	17-630.....	84
17-443.....	102	17-529.....	108	17-581.....	81	17-631.....	84
17-460.....	69	17-530.....	106	17-582.....	78	17-632.....	87
17-461.....	69	17-531.....	106	17-583.....	78	17-633.....	87
17-462.....	69	17-534.....	113	17-584.....	79	17-634.....	67
17-463.....	69	17-535.....	113	17-585.....	79	17-635.....	67

17-636 67	17-708 101	17-772 96	17-860 114
17-637 67	17-709 101	17-773 96	17-861 114
17-638 68	17-710 100	17-778 98	17-862 115
17-639 68	17-711 100	17-779 98	17-863 115
17-640 87	17-714 82	17-780 97	17-864 115
17-641 87	17-715 82	17-781 97	17-865 115
17-642 87	17-716 82	17-782 98	17-866 115
17-643 87	17-717 82	17-783 98	17-867 115
17-648 101	17-720 88	17-784 97	17-868 115
17-649 101	17-721 88	17-785 97	17-869 115
17-656 85	17-722 88	17-786 97	17-870 115
17-657 85	17-723 88	17-787 97	17-871 115
17-658 85	17-724 88	17-788 97	17-872 115
17-659 85	17-725 88	17-789 97	17-873 115
17-660 85	17-734 94	17-792 97	17-880 115
17-661 85	17-735 94	17-793 97	17-881 115
17-670 116	17-736 94	17-794 97	17-912 109
17-671 116	17-737 94	17-795 97	17-913 109
17-672 116	17-738 95	17-796 97	17-914 109
17-673 116	17-739 95	17-797 97	17-915 109
17-676 99	17-740 94	17-798 98	17-920 109
17-677 99	17-741 94	17-799 98	17-921 109
17-678 99	17-744 94	17-804 98	17-922 109
17-679 99	17-745 94	17-805 98	17-923 109
17-680 99	17-746 94	17-810 86	17-924 109
17-681 99	17-747 94	17-811 86	17-925 109
17-682 71	17-748 94	17-812 86	17-926 109
17-683 71	17-749 94	17-813 86	17-927 109
17-684 99	17-750 95	17-814 86	17-928 109
17-685 99	17-751 95	17-815 86	17-929 109
17-686 99	17-752 95	17-840 114	17-930 110
17-687 99	17-753 95	17-841 114	17-931 110
17-688 99	17-754 95	17-842 114	17-932 109
17-689 99	17-755 95	17-843 114	17-933 109
17-690 100	17-756 95	17-844 114	17-936 110
17-691 100	17-757 95	17-845 114	17-937 110
17-692 100	17-758 95	17-846 114	17-940 110
17-693 100	17-759 95	17-847 114	17-941 110
17-694 100	17-760 96	17-848 114	17-946 110
17-695 100	17-761 96	17-849 114	17-947 110
17-696 101	17-762 96	17-850 114	17-960 90
17-697 101	17-763 96	17-851 114	17-961 90
17-698 71	17-764 96	17-852 114	17-962 90
17-699 71	17-765 96	17-853 114	17-963 90
17-700 83	17-766 96	17-854 114	17-964 90
17-701 83	17-767 96	17-855 114	17-965 90
17-702 83	17-768 96	17-856 114	17-966 90
17-703 83	17-769 96	17-857 114	17-967 90
17-706 101	17-770 96	17-858 114	17-968 90
17-707 101	17-771 96	17-859 114	17-969 90

PART NUMBER INDEX

UHB800-CAM

17-970 90	18-518 60	18-650 64	18-732 45
17-971 90	18-519 60	18-651 64	18-733 45
17-972 90	18-520 60	18-652 64	18-734 45
17-973 90	18-521 60	18-653 64	18-735 45
17-974 90	18-522 60	18-654 64	18-736 45
17-975 90	18-523 60	18-655 64	18-737 45
17-976 90	18-524 60	18-656 64	18-738 46
17-977 90	18-525 60	18-657 64	18-739 46
17-978 90	18-526 61	18-658 64	18-740 46
17-979 90	18-527 61	18-659 64	18-741 46
17-980 90	18-528 61	18-660 64	18-742 46
17-981 90	18-529 61	18-661 64	18-743 46
17-982 91	18-530 61	18-670 63	18-744 47
17-983 91	18-531 61	18-671 63	18-745 47
17-984 91	18-532 61	18-672 63	18-746 46
17-985 91	18-533 61	18-673 63	18-747 46
17-986 91	18-534 61	18-674 63	18-748 46
17-987 91	18-535 61	18-675 63	18-749 46
17-988 91	18-536 61	18-676 63	18-750 47
17-989 91	18-537 61	18-677 63	18-751 47
17-990 91	18-538 61	18-678 63	18-752 47
17-991 91	18-539 61	18-679 63	18-753 47
17-992 91	18-540 61	18-680 63	18-754 47
17-993 91	18-541 61	18-681 63	18-755 47
17-994 91	18-542 62	18-682 63	18-760 29
17-995 91	18-543 62	18-683 63	18-761 29
17-996 90	18-620 42	18-684 63	18-762 29
17-997 90	18-621 42	18-685 63	18-763 29
18-1127 49	18-622 42	18-688 63	18-764 29
18-1128 49	18-623 42	18-689 63	18-765 29
18-1129 39	18-624 42	18-704 28	18-766 29
18-1130 39	18-625 42	18-705 28	18-767 29
18-500 59	18-626 42	18-708 44	18-768 29
18-501 59	18-627 42	18-709 44	18-769 29
18-502 59	18-628 42	18-710 56	18-770 30
18-503 59	18-629 42	18-711 56	18-771 30
18-504 59	18-630 42	18-712 58	18-772 30
18-505 59	18-631 42	18-713 58	18-773 30
18-506 59	18-634 42	18-714 58	18-774 30
18-507 59	18-635 42	18-715 58	18-775 30
18-508 59	18-640 64	18-716 58	18-776 30
18-509 59	18-641 64	18-717 58	18-777 30
18-510 60	18-642 64	18-724 53	18-778 30
18-511 60	18-643 64	18-725 53	18-779 30
18-512 60	18-644 64	18-726 45	18-780 58
18-513 60	18-645 64	18-727 45	18-781 58
18-514 60	18-646 64	18-728 45	18-782 51
18-515 60	18-647 64	18-729 45	18-783 51
18-516 60	18-648 64	18-730 45	18-784 52
18-517 60	18-649 64	18-731 45	18-785 52

18-786 53	18-840 37	18-892 34	18-964 31
18-787 53	18-841 37	18-893 34	18-965 31
18-790 54	18-842 37	18-894 34	18-966 31
18-791 54	18-843 37	18-895 34	18-967 31
18-792 51	18-844 37	18-896 34	18-968 31
18-793 51	18-845 37	18-897 34	18-969 31
18-794 51	18-846 37	18-898 34	18-970 31
18-795 51	18-847 37	18-899 34	18-971 31
18-796 55	18-848 37	18-900 34	18-972 31
18-797 55	18-849 37	18-901 34	18-973 31
18-798 56	18-850 55	18-902 35	18-974 31
18-799 56	18-851 55	18-903 35	18-975 31
18-800 51	18-852 53	18-904 35	18-976 31
18-801 51	18-853 53	18-905 35	18-977 31
18-802 51	18-854 51	18-906 35	18-978 32
18-803 51	18-855 51	18-907 35	18-979 32
18-804 51	18-856 39	18-908 35	18-980 32
18-805 51	18-857 39	18-909 35	18-981 32
18-806 52	18-858 39	18-910 43	18-982 48
18-807 52	18-859 39	18-911 43	18-983 48
18-808 52	18-860 55	18-930 59	18-984 48
18-809 52	18-861 55	18-931 59	18-985 48
18-810 52	18-862 55	18-936 41	18-986 50
18-811 52	18-863 55	18-937 41	18-987 50
18-812 53	18-864 55	18-938 41	18-988 50
18-813 53	18-865 55	18-939 41	18-989 50
18-814 53	18-866 57	18-940 48	18-990 33
18-815 53	18-867 57	18-941 48	18-991 33
18-816 54	18-868 57	18-942 48	18-992 33
18-817 54	18-869 57	18-943 48	18-993 33
18-818 54	18-872 39	18-944 48	18-994 49
18-819 54	18-873 39	18-945 48	18-995 49
18-820 57	18-874 39	18-946 48	18-996 49
18-821 57	18-875 39	18-947 48	18-997 49
18-822 58	18-876 40	18-948 36	31-1400 143
18-823 58	18-877 40	18-949 36	31-1401 143
18-824 55	18-878 58	18-950 36	31-1402 143
18-825 55	18-879 58	18-951 36	31-1403 143
18-826 56	18-880 38	18-952 36	31-1404 143
18-827 56	18-881 38	18-953 36	31-1405 144
18-828 56	18-882 37	18-954 36	31-1405 144
18-829 56	18-883 37	18-955 36	31-1406 144
18-830 56	18-884 38	18-956 36	31-1406 144
18-831 56	18-885 38	18-957 36	31-1410 143
18-832 57	18-886 38	18-958 36	31-1411 143
18-833 57	18-887 38	18-959 36	31-1412 143
18-834 58	18-888 56	18-960 31	31-1413 143
18-835 58	18-889 56	18-961 31	31-1415-1 144
18-836 57	18-890 34	18-962 31	31-1415-1 144
18-837 57	18-891 34	18-963 31	31-1415-2 144

31-1415-2	144	43-7038	122
31-1419	143	43-7039	122
31-1420	143	43-7039A	123
31-1429	143	43-7040	123
31-1430	144	43-7041	124
31-1431	144	43-7042	124
31-1432	144	43-7043A	125
31-1439	143	43-7044	125
31-1440	143	43-7044A	126
31-1441	143	43-7046	126
31-1442	144	43-7046A	127
31-1443	144	43-7047	127
31-1444	143	43-7048	128
31-1445	143	43-7048A	128
31-1447	143	43-7050	129
31-1448	143	43-7051	129
31-1448AM	144	43-7053A	130
31-1449	143	43-7056	130
31-1449AM	143	43-7059	131
31-1450	143	43-7060	131
31-1450	144	43-7062	132
31-1451	143	43-7064	132
31-1452	143	43-7065	133
31-1453	143	43-7068	133
31-1455	143	43-7069	134
31-1456	143	43-7070	134
31-1457	144	43-7071	135
31-1458	144	43-7072	135
31-1459	143	43-7072A	136
31-1460	144	43-7080	136
31-1461	144	43-7081	137
31-1462	144	43-7090	137
31-1463	144	43-7091	138
31-1464	144	43-7092	138
31-1465	144	43-7100	139
31-1466	144	43-7101	139
31-1467	144	43-7110	140
31-1467	144	43-7115	140
31-1468	144	43-7117	141
31-1468	144	43-7118	141
43-7029	117		
43-7030	117		
43-7031	118		
43-7032	118		
43-7032A	119		
43-7033	119		
43-7034	120		
43-7037	120		
43-7037A	121		
43-7037B	121		



Dana Corporation strives to publish catalogs that are as accurate and user-friendly as possible. Continuous improvement is our ongoing mission. Therefore, we welcome any and all of our customers' comments. Please forward your comments with any suggested improvements or corrections to our Catalog Department via Fax or mail.

Fax: Product Management / Catalog Department
(419) 866-3924

Mail: Dana Corporation
Commercial Vehicle Service Parts
Attn: Product Management / Catalog Department
PO Box 321
Toledo, OH 43697-0321

Comments and Suggested Improvement/Corrections	Page Number	Part Number

SPICER[®]



Dana Corporation
Commercial Vehicle Service Parts
P.O. Box 321
Toledo, Ohio 43697-0321
1-800-SAY-DANA (729-3262)
www.dana.com
www2.dana.com/expert

Dana Canada
5095 South Service Road
Beamsville, Ontario LOR 1B0

Roadranger[®]
MORE TIME ON THE ROAD.™
1-800-826-HELP (4357)
<http://roadranger.com>